



GESAMTPROGRAMM

RANGE OF PRODUCTS



- Bänninger Unternehmensgruppe
- Worldwide
- Made in Germany



MADE IN GERMANY – SEIT MEHR ALS 30 JAHREN

Die Bänninger Unternehmensgruppe ist ein Familienunternehmen, das erfolgreich in dritter Generation geführt wird. Unser lang anhaltender Erfolg ist das Ergebnis eines einfachen Rezeptes: Bei uns steht der Mensch im Mittelpunkt aller Überlegungen. Wir produzieren Rohre und Formteile, die für die Menschen, die sie verarbeiten und verwenden, echte „Problemlöser“ sind.

Genau dieser Sicht – die bei uns von Generation zu Generation weitergegeben wird – entspringt unser hoher Anspruch an die Qualität. Auch aus diesem Grund sind wir nach DIN EN ISO 9001 sowie DIN EN ISO 50001 zertifiziert.

Die Wurzeln dieser Unternehmensphilosophie reichen weit in die Geschichte der Bänninger GmbH zurück. Einem Unternehmen, das bereits im Jahr 1909 gegründet wurde. 1987 erfolgte die Unternehmensübernahme durch die Familien Stamm und Ertl. Seither produziert das Unternehmen in Eigenregie und firmiert als Bänninger Kunststoff-Produkte GmbH.

Damit begann ein bis heute andauerndes Wachstum, das auf Ideenreichtum, Know-how, einem außergewöhnlichen Qualitätsanspruch und einem soliden betriebswirtschaftlichen Geschick basiert. Nicht zuletzt unser modernes Energiemanagement zeigt: Ökologisches Denken und Handeln bilden feste Bestandteile in unserem unternehmerischen Alltag.

Als Systemanbieter offerieren wir unsere Lösungen weltweit – das Stichwort lautet „Global Solutions“!

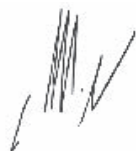

Hendrik Ertl
CEO/geschäftsführender
Gesellschafter



Christoph Stamm
CEO/geschäftsführender
Gesellschafter

MADE IN GERMANY – FOUNDED MORE THAN 30 YEARS AGO

The Bänninger Group is a successful family business in its third generation. Our long-term success is the result of a simple formula: we develop our pipes and moulded parts as a problem-solver from the perspective of our customers.

It is precisely this standpoint - which we pass on from generation to generation - that is the source of our high quality standard. We are also certified in accordance with DIN EN ISO 9001 and DIN EN ISO 50001 for this reason.

Hence, this corporate philosophy is deeply rooted at Bänninger GmbH. Bänninger was founded 1909. In 1987 the Stamm and Ertl families acquired the plastics division of the company and changed the name to Bänninger Kunststoff-Produkte GmbH.

The new company quickly started to grow and has continued to grow to this day. Our growth is based on innovation, know-how, an extraordinary quality standard and sound business skills. Ecological thinking and conduct are part of our daily business. This is also visible in our state-of-the-art energy management.

As a global system provider, we offer our solutions worldwide.



Teilenummern • Item Numbers

Alle BR-Verkaufsartikel haben eine 10-stellige und für alle Produktbereiche einheitlich aufgebaute Artikelnummer, die aus 3 Blöcken (4 4 2) besteht. Um bei Bestellungen Verwechslung auszuschließen, ist diese Artikelnummer immer vollständig anzugeben.

All BR sales items have a 10-digit article number, which consists of 3 blocks (4 4 2), which is uniform for all product groups. In order to exclude confusion when placing orders, this item number must always be specified completely.

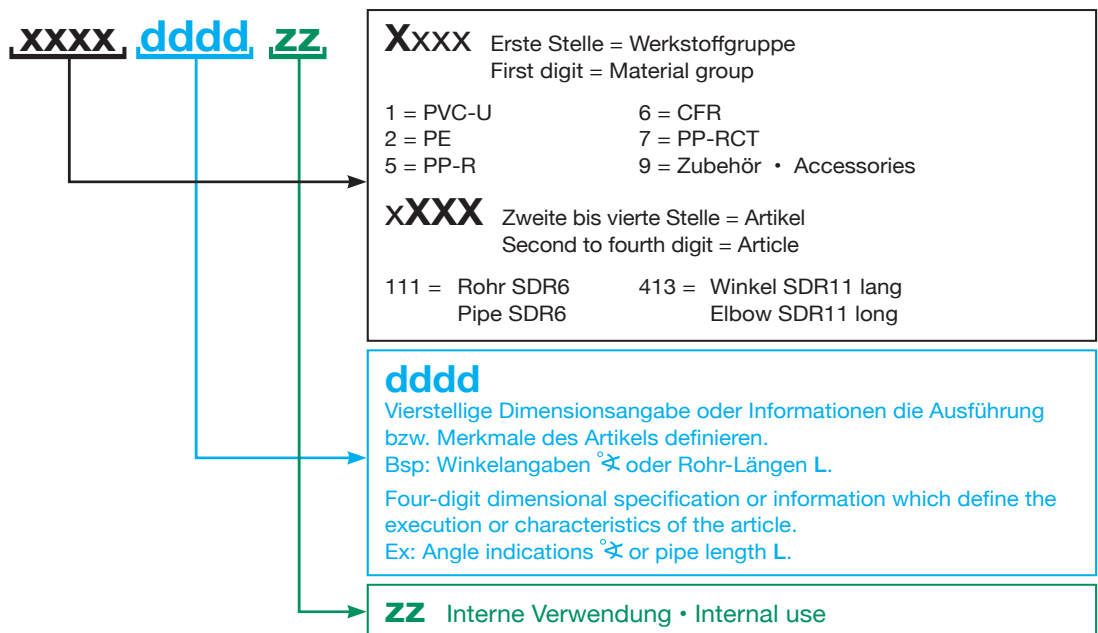

Bestellbeispiel • Order example 1

PE100 Winkel 90° lang SDR11 schwarz D125
PE100 Elbow 90° long SDR11 black D125

2413 15 90 15
PE D125 ∅ = 90°

Bestellbeispiel • Order example 2

PP-R Rohr G 8200 SDR 6 grün 4m D50
PP-R Pipe G 8200 SDR 6 green 4m D50

5111 10 40 11
PP-R D50 L=4m

Teile mit Metalleinleger • Items with metal inserts

Auf Grund gesetzlicher Vorgaben außereuropäischer Länder und einem steigenden internationalen Umwelt- und Gesundheitsbewußtsein, beginnen wir ab sofort bei den Übergängen mit der Umstellung der Metalleinleger von Rotguss auf bleifreies Messing (LFB), um weltweit alle Anforderungen mit nur einem metallischen Werkstoff zu erfüllen.

Bei den Artikelnummern wird der Buchstabe „R“ durch ein „L“ ersetzt.

Bsp: 1**R**10 0643 11 ⇔ 1**L**10 0643 11

Die beiden Materialien können bedenkenlos miteinander eingesetzt werden.

Due to legal requirements from non-European countries and increasing international environmental and health awareness, from now on we start to change the metal parts in our transition fittings from red brass to lead free brass (LFB). This has been decided in order to account global requirements with only one metal material.

Regarding the item numbers, the letter “R” is replaced by “L”.

Example 1**R**10 0643 11 ⇔ 1**L**10 0643 11

The two materials can be used in combination without any problems.

**Zählweise bei Formteilen mit Abgängen
Counting at fittings with outlets**

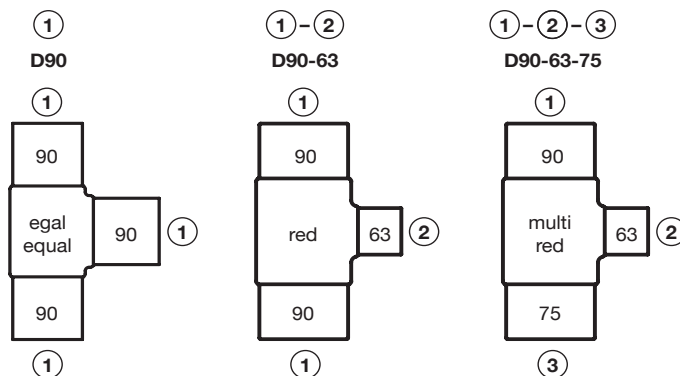

i Dimension

mm	Code	Inch	fem	male
		Zoll	IG	AG
6	01	1/8	40	70
8	02	1/4	41	71
10	03	3/8	42	72
12	04	1/2	43	73
16	05 A	5/8	44	74
20	06 B	3/4	45	75
25	07 C	1	46	76
32	08 D	1 1/4	47	77
40	09 E	1 1/2	48	78
50	10 F	1 3/4	49	79
63	11	2	50	80
75	12	2 1/4	51	81
90	13	2 3/8	52	82
110	14	2 1/2	53	83
125	15	2 3/4	54	84
140	16	3	55	85
160	17	3 1/2	56	86
180	18	4	57	87
200	19	5	58	88
225	20	6	59	89
250	21	7	60	90
280	22	8	61	91
315	23	10	62	92
355	24	12	63	93
400	25			
450	26			
500	27			
560	28			
630	29			
710	30			
800	31			
900	32			
1000	33			
1200	34			



i INFO	i INFO		i 1
	<ul style="list-style-type: none"> ▪ Teilenummern ▪ Teile mit Metalleinleger ▪ Zählweise bei Formteilen mit Abgängen ▪ Bänninger-Erfolgsstory 	Item Numbers Items with metal inserts Counting at fittings with outlets Bänninger A Success Story	i 1 i 1 i 1 i 4
PVC-U	1 PVC-U		PVC 1
	1.01	Rohre einlagig	Pipes single layer
	1.02	Formteile	Fittings
	1.02.01	Bögen, Winkel	Bends, Elbows
	1.02.02	T-Stücke, Abzweige	Tee's, Branches
	1.02.03	Reduktionen, Muffen, Kappen	Reducers, Sockets, Caps
	1.02.04	Übergänge	Transitions
	1.02.05	Verschraubungen	Unions
	1.02.06	Flanschverbindung	Flange connection
	1.02.07	Formteile mit Kunststoff-Gewinde	Fittigs with plastic-thread
1.02.08	Kugelhähne	Ball valves	
1.02.09	Ventile	Valves	
PE 100	2 PE100		PE 1
	2.01	Rohre mehrlagig	Pipes multi-layer
	2.02	Formteile lang	Fittings long
	2.02.01	Winkel lang	Elbows long
	2.02.02	T-Stücke, Abzweige lang	Tee's, Branches long
	2.02.03	Reduktionen, Kappen lang	Reducers, Caps long
	2.02.04	Übergänge lang	Transitions long
	2.02.05	Verschraubungen lang	Unions long
	2.02.06	Flanschverbindung lang	Flange connection
	2.02.07	Kugelhähne lang	Ball Valves long
2.03	Formteile kurz	Fittings short	
2.03.01	Bögen, Winkel kurz	Bends, Elbows short	
2.03.02	T-Stücke kurz	Tee's short	
2.03.03	Reduktionen kurz	Reducers short	
2.03.04	Übergänge kurz	Transitions short	
2.03.05	Flanschverbindung kurz	Flange connection short	
2.04	E-Formteile	E-Fittings	
2.05	Rohrbögen nahtlos	Pipe bends seamless	
PP-R	3 PP-R		PPR 1
	3.01	Rohre einlagig	Pipes single-layer
	3.02	Formteile Muffen-Schweißen	Fittings socket-welding
	3.02.01	Bögen, Winkel	Bends, Elbows
	3.02.02	T-Stücke	Tee's
	3.02.03	Reduktionen, Muffen, Kappen	Reducers, Sockets, Caps
	3.02.04	Übergänge	Transitions
	3.02.05	Übergänge Wand	Transitions wall
	3.02.06	Verschraubungen	Unions
3.02.07	Kugelhähne	Ball valves	
3.02.08	Ventile	Valves	
PP-RCT	4 PP-RCT		RCT 1
	4.01	Rohre	Pipes
	4.01.01	Rohre einlagig	Pipes single-layer
	4.01.02	Rohre mehrlagig	Pipes multi-layer
	4.01.03	Sonderrohre	Special Pipes
	4.02	Formteile Muffen-Schweißen	Fittings socket-welding
	4.02.01	Bögen, Winkel	Bends, Elbows
	4.02.02	T-Stücke, Abzweige	Tee's, Branches
	4.02.03	Reduktionen, Muffen, Kappen	Reducers, Sockets, Caps
	4.02.04	Übergänge	Transitions
	4.02.05	Übergänge Wand	Transitions wall
	4.02.06	Verschraubungen	Unions
	4.02.07	Flanschverbindung	Flange connection
	4.02.08	Einschweißsättel	Weld-in-saddles
4.02.09	Verteiler	Manifolds	
4.02.10	Kugelhähne	Ball valves	
4.02.11	Ventile	Valves	
4.03	Formteile Stumpf-Schweißen	Fittings butt-welding	
4.03.01	Winkel	Elbows	
4.03.02	T-Stücke	Tee's	
4.03.03	Reduktionen, Kappen	Reducers, Caps	
4.03.04	Flanschverbindung	Flange connection	
4.04	Formteile Heizwendel-Muffen-Schweißen	Fittings electrofusion-socket-welding	



PP-INDUSTRIAL	5 PP-INDUSTRIAL		IND 1
	5.01 Rohre	Pipes	IND 3
	5.01.01 Rohre einlagig	Pipes single-layer	IND 3
	5.01.02 Rohre mehrlagig	Pipes multi-layer	IND 5
	5.02 Formteile Muffen-Schweißen	Fittings socket-welding	IND 6
	5.02.01 Winkel	Elbows	IND 6
	5.02.02 T-Stücke, Abzweige	Tee's, Branches	IND 7
	5.02.03 Reduktionen, Muffen, Kappen	Reducers, Sockets, Caps	IND 8
	5.02.04 Verschraubungen	Unions	IND 9
	5.02.05 Flanschverbindung	Flange connection	IND 10
	5.02.06 Kugelhähne	Ball Valves	IND 11
	5.03 Formteile Stumpf-Schweißen	Fittings butt-welding	IND 12
	5.03.01 Bögen, Winkel	Bends, Elbows	IND 12
	5.03.02 T-Stücke	Tee's	IND 13
5.03.03 Reduktionen	Reducers	IND 14	
5.03.04 Übergänge	Transitions	IND 15	
5.03.05 Verschraubungen	Unions	IND 16	
5.03.06 Flanschverbindung	Flange connection	IND 18	
5.04 Armaturen	Valves	IND 20	
CFR FIRETEC	6 CFR FIRETEC		CFR 1
	6.01 Rohre mehrlagig	Pipes multi-layer	CFR 3
	6.02 Formteile Muffen-Schweißen	Fittings socket-welding	CFR 4
	6.02.01 Winkel	Elbows	CFR 4
	6.02.02 T-Stücke, Abzweige	Tee's, Branches	CFR 5
	6.02.03 Reduktionen, Muffen, Kappen	Reducers, Sockets, Caps	CFR 6
	6.02.04 Übergänge	Transitions	CFR 7
	6.02.05 Übergänge Wand	Transitions wall	CFR 8
	6.02.06 Verschraubungen	Unions	CFR 9
	6.02.07 Flanschverbindung	Flange connection	CFR 9
6.02.08 Einschweißsättel	Weld-in-saddles	CFR 10	
6.02.09 Kugelhähne	Ball Valves	CFR 10	
WORKTEC	7 WORKTEC		WOT 1
	Vorfertigung von Sonderbauteilen	Prefabrication of special items	WOT 1
	Vorschweißbunde in Sonderlänge	Flange adaptors spigot in special lengths	WOT 1
	Flanschverbindungsteile	Flange connection items	WOT 1
	Verteiler / Sammler	Manifolds / collectors	WOT 2
ZUBEHÖR	Z Zubehör • Accessories		ZUB 1
	Z.01 Flansche	Flanges	ZUB 2
	Z.01.01 Losflansche DIN-EN	Flanges DIN-EN	ZUB 2
	Z.01.02 Losflansche ANSI	Flanges ANSI	ZUB 5
	Z.01.03 Sonder-Flanschverbindung	Special Flange connection	ZUB 7
	Z.02 Dichtungen	Gaskets	ZUB 9
	Z.02.01 Runddichtringe	O-Ring-Gaskets	ZUB 9
	Z.02.02 Flachdichtringe	Flat-Gaskets	ZUB 10
	Z.02.03 Flachdichtringe mit Stahleinlage	Flat-Gaskets with Steel-inlay	ZUB 11
	Z.03 Clipse und Schellen	Clips and clamps	ZUB 13
	Z.04 Montagematerial	Mounting material	ZUB 14
	Z.05 Werkzeuge	Installation tools	ZUB 15
	Z.05.01 Schneiden	Cutting	ZUB 15
	Z.05.02 Reinigen	Cleaning	ZUB 19
	Z.05.03 Kleben	Bonding	ZUB 19
	Z.05.04 Heizelement-Muffen-Schweißen	Socket welding	ZUB 20
	Z.05.05 Heizelement-Stumpf-Schweißen	Butt welding	ZUB 23
	Z.05.06 Heizwendel-Muffen-Schweißen	Electrofusion-socket welding	ZUB 30
	Z.05.07 Einschweißsättel	Weld-in-saddles	ZUB 35
Z.05.08 Schälwerkzeuge Stabitec	Peeling tools Stabitec	ZUB 37	
Z.05.09 Reparatursets	Repair sets	ZUB 37	
Z.05.10 Verschiedenes	Miscellaneous	ZUB 38	
Z.06 Armaturen	Valves	ZUB 39	
ANHANG	A Anhang		A 1
	A1 Zeichenerklärung	Legend	A 2
	A2 Rechtliche Hinweise	Legal notice	A 3
	A3 Verkaufsbedingungen	Conditions of sale	A 4

BÄNNINGER – WELTWEIT EIN VERLÄSSLICHER PARTNER

Kundenzufriedenheit und Loyalität sind das Maß der Dinge. Wer einmal Kunde von Bänninger ist, bleibt es auch. Dafür gibt es gute Gründe. Die hohe Flexibilität gehört genauso dazu wie die Kombination aus innovativer Technik und der Erfahrung der Mitarbeiter sowie die individuelle und passgenaue Beratung.



■ WERTE ALS MASSSTAB

Unser Umgang mit Geschäftspartnern ist offen und ehrlich. Unsere Kommunikation ist geprägt von gegenseitiger Wertschätzung und Vertrauen.

Das Tagesgeschäft hat ethische Werte und allgemein akzeptierte gesellschaftliche Regeln als Leitplanken.

■ NACHHALTIGKEIT UND NACHHALTIGE ZUSAMMENARBEIT

Nachhaltigkeit und ökologische Verantwortung spielen bei allen unternehmerischen Entscheidungen und in der gesamten Wertschöpfungskette eine zentrale Rolle bei Bänninger. Das gesellschaftliche Engagement ist Teil der Unternehmenskultur.

BÄNNINGER-VORTEILE EIN ÜBERBLICK:

- Know-how, Erfahrung und innovative Produkte
- Produktion „Made in Germany“
- Weltweite Verfügbarkeit mit einem exzellenten Service
- Hohe Flexibilität und individuelle Beratung
- Zertifizierte Prozesse

BÄNNINGER – WORLDWIDE A RELIABLE PARTNER

Customer satisfaction and loyalty are our yardstick. We have a high rate of customer retention. There are good reasons for this. A high degree of flexibility is one of them. So is the combination of innovative technology and employees' experience as well as customised consultation.

■ VALUES AS A BENCHMARK

Our relationships with business partners are open and honest, characterized by mutual respect and trust.

In our daily business, ethical values and generally accepted social rules serve as guidelines.



■ SUSTAINABILITY AND SUSTAINABLE COOPERATION

Sustainability and ecological responsibility play a key role for all entrepreneurial decisions and in the entire value chain at Bänninger. Social commitment is part of the corporate culture.

BÄNNINGER ADVANTAGES AN OVERVIEW:

- Know-how, experience and innovative products
- Production „Made in Germany“
- Worldwide availability with excellent service
- High degree of flexibility and customised consultation
- Certified processes

AUF WISSEN UND ERFAHRUNG VERTRAUEN

International gelten wir als ein Hersteller, der im Druckbereich absolut zuverlässig ist und dessen Produkte hohe Sicherheitsstandards gewährleisten.

Die Gründe dafür liegen im Wissen und in der Erfahrung, die wir im Laufe der vergangenen Jahre und Jahrzehnte gesammelt haben – und in der hohen Motivation der Mitarbeiterinnen und Mitarbeiter.

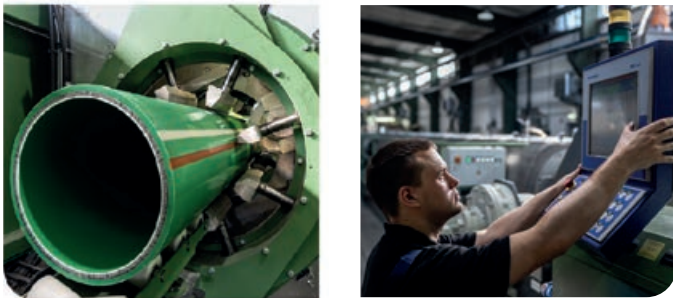

■ AUF DEN PUNKT: DAS ENGINEERING

Die Entwicklung von Produkten erfordert eine Vielzahl besonderer Kompetenzen: Innovatives Denken und Handeln, fachliches Know-how und die entsprechende technische Ausstattung. Hinzu kommt die Kompetenz zur individuellen Konstruktion, die Erfahrung im Umgang mit den Werkstoffen und die Fähigkeit zur Beratung.

■ ENGINEERING IST KEIN SELBSTZWECK

Bei Bänninger ist die Entwicklung neuer Produkte kein Selbstzweck. Es geht nicht darum, was möglich ist. Es geht um die Anforderungen, vor denen die Verarbeiter und Verwender stehen.

Der intensive Kontakt und Austausch mit den Kunden weltweit sorgt dafür, dass wir exakt die Produkte entwickeln, die der Markt benötigt – das ist der Grund für den nachhaltigen Erfolg der Bänninger Kunststoff-Produkte.

TRUST IN KNOWLEDGE AND EXPERIENCE

Internationally, we are regarded as an absolutely reliable manufacturer in the high-pressure range and one whose products guarantee a high safety standard.

The reasons for this lie in our knowledge and experience, which have been accumulated over the course of decades as well as in the high level of motivation of our employees.

■ IN A NUTSHELL: THE ENGINEERING

The development of products needs skills, primarily the capability to create new innovations in know-how and technical equipment. This includes the skills for performing our own engineering and design, for handling materials and for consulting.

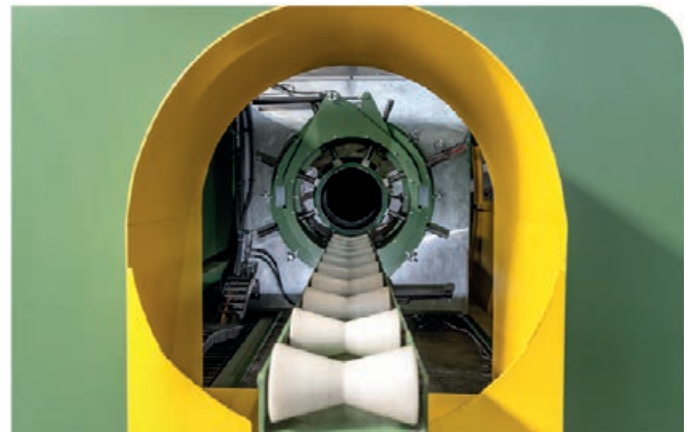

■ ENGINEERING IS NOT AN END IN ITSELF

At Bänninger, the development of new products is not an end in itself; it is not about what is possible, it is about meeting the requirements of the customers and the challenges they face.

The intensive contact and exchange with the customers worldwide ensure products that the market needs - that is the basis for Bänninger's long-term success.

SECHS ARGUMENTE, DIE ÜBERZEUGEN

SIX CONVINCING ARGUMENTS

- 1** **ERFAHRUNG UND KNOW-HOW ...**
zeichnen die Mitarbeiterinnen und Mitarbeiter von Bänninger aus.
Experience and know-how distinguish Bänninger employees.
- 2** **BERATUNG ...**
schafft das Fundament für die erfolgreichen Projekte unserer Kunden.
Consultation creates the foundation for our customers' successful products.
- 3** **INNOVATIONEN ...**
machen heute die Verwirklichung von Projekten von morgen möglich.
Innovations make it possible to realise the projects of tomorrow today.
- 4** **MODERNSTE TECHNOLOGIE ...**
sorgt für das notwendige Plus an Effizienz.
State-of-the-art technology ensures the necessary extra efficiency.
- 5** **QUALITÄT ...**
in höchster Form sorgt für beruhigende Sicherheit.
Quality in the highest form guarantees reassuring safety.
- 6** **STARKER SERVICE ...**
beginnt bei uns mit dem Mitdenken.
Strong service starts with us by thinking like our customers.

1 PVC-U

Als zweitältester Massenkunststoff der Welt hat sich PVC-U in den unterschiedlichsten Anwendungen bewährt. Seit Mitte der 1930er Jahre gibt es Formteile aus PVC-U. Diese zeichnen sich unter anderem durch ihre Trinkwassereignung und eine hohe chemische Beständigkeit aus.

Eigenschaften

- Hohe chemische Beständigkeit
- Hervorragende Verarbeitbarkeit

Werkstoff

Polyvinylchlorid (PVC) ist ein amorpher thermoplastischer Kunststoff, RAL 7011 Eisengrau

Verbindungstechnik

- Klebung
- Flanschverbindung

As the second-oldest mass plastic in the world, PVC-U has been approved and tested in various applications. Since the mid-1930s, fittings made of PVC-U have been used. They convince with very good properties for the usage in drinking water and by their high chemical resistance.

Properties

- High chemical resistance
- Excellent processing capability

Material

Polyvinyl Chloride (PVC) is an amorphous thermoplastic polymer, RAL 7011 Iron grey

Joining technology

- Bonding
- Flange connection



1.01 Rohre einlagig • Pipes single layer **PVC 3**

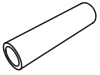

1.02 Formteile • Fittings **PVC 4**

1.02.01 Bögen, Winkel **PVC 5**
Bends, Elbows

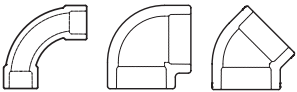

1.02.07 Formteile mit Kunststoff-Gewinde **PVC 23**
Fittings with plastic-thread

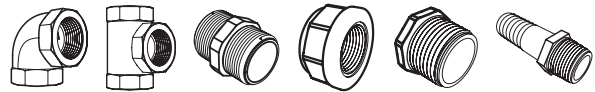

1.02.02 T-Stücke, Abzweige **PVC 6**
Tee's, Branches

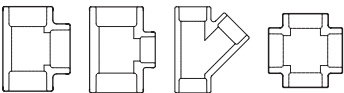

1.02.08 Kugelhähne **PVC 25**
Ball valves

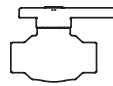

1.02.03 Reduktionen, Muffen, Kappen **PVC 8**
Reducers, Sockets, Caps

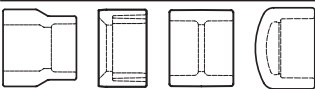

1.02.09 Ventile **PVC 26**
Valves

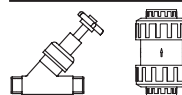

1.02.04 Übergänge **PVC 11**
Transitions

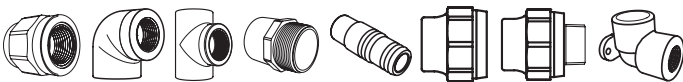

1.02.05 Verschraubungen **PVC 15**
Unions

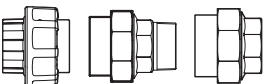

1.02.06 Flanschverbindung **PVC 20**
Flange connection

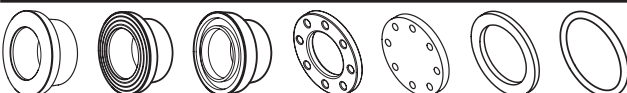

1.01 Rohre einlagig • Pipes single-layer

PVC-U Druckrohr

Beschreibung

PVC-U Druckrohr, homogen, einschichtig, SDR13,6/21, ähnlich RAL 7011 Eisengrau. Einsetzbar für Trinkwasser, Abwasser und industrielle Anwendungen.

Werkstoff

PVC-U (weichmacherfreies Polyvinylchlorid) ohne Füllstoffe. Das Material entspricht den Anforderungen der aktuellen KTW-Leitlinie des Umweltbundesamtes (UBA).

Geometrische Eigenschaften

Abmessungen und Toleranzen entsprechend DIN 8061/62 (Druckrohre), DIN EN ISO 1452 (Wasserversorgung und Abwasserleitung), DIN EN ISO 15493 (Industrie).

Betriebsdruck

SDR13,6 = PN16 (20°C/1,6 MPa)

SDR21 = PN10 (20°C/1,0 MPa)

Ausführung

Alle Rohre mit glatten Enden.

Zertifizierung

PVC-U Rohre unterliegen regelmäßigen internen und externen Qualitätskontrollen. ZP 1.1.1 der DIN CERTCO und DVGW GW 335-A1.

Lieferung

In 5 m Stangen; lose gepackt. Andere Längen auf Anfrage. Abgabe erfolgt nur in kompletten Rohrlängen und Verpackungseinheiten (VEs).

PVC-U pressure pipe

Description

PVC-U Pressure pipe, homogeneous single-layer, SDR13.6/21, similar to RAL 7011 Iron grey.

Useable for drinking water, drainage water and industrial applications.

Material

PVC-U (unplasticized Polyvinylchloride) without fillers. The material complies with the requirements of the KTW guideline of the German Federal Environmental Agency (UBA).

Geometric Properties

Dimensions and tolerances according to DIN8061/62 (Pressure pipes), DIN EN ISO 1452 (Water supply and drainage water), DIN EN ISO 15493 (Industrial).

Operating pressure

SDR13.6 = PN16 (20°C/1.6 MPa)

SDR21 = PN10 (20°C/1.0 MPa)

Type

All pipes with plain ends.

Certification

PVC-U pipes succumb frequent internal and external quality controls. ZP 1.1.1 of DIN CERTCO and DVGW GW 335-A1.

Delivery

In 5 m rods; loosely packed. Other lengths on request. Supply only in complete lengths and packing units (PU's).

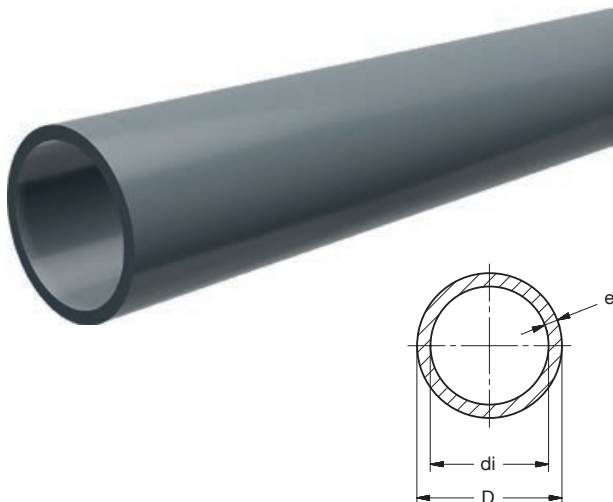

PVC-U Druckrohr **PN16** SDR13,6 grau 5m

PVC-U Pressure pipe **PN16** SDR13.6 grey 5m

Art Nr	D	e	di	SDR	L	KG	VE1	VE2
Art No	[mm]		[mm]		[m]		PU1	PU2
1112 0550 32	16	1,2	13,6	13,6	5	0,09	5	2400
1112 0650 32	20	1,5	17,0	13,6	5	0,14	5	2500
1112 0750 32	25	1,9	21,2	13,6	5	0,22	5	2400
1112 0850 32	32	2,4	27,2	13,6	5	0,35	5	1015
1112 0950 32	40	3,0	34,0	13,6	5	0,53	5	1105
1112 1050 32	50	3,7	42,6	13,6	5	0,82	5	1075
1112 1150 32	63	4,7	53,6	13,6	5	1,31	5	545
1112 1250 32	75	5,6	63,8	13,6	5	1,85	5	500
1112 1350 32	90	6,7	76,6	13,6	5	2,64	5	370
1112 1450 32	110	8,1	93,8	13,6	5	3,91	5	300
1112 1550 32	125	9,2	106,6	13,6	5	5,04	5	190
1112 1650 32	140	10,3	119,4	13,6	5	6,30	5	165
1112 1750 32	160	11,8	136,4	13,6	5	8,23	5	140
1112 1850 32	180	13,3	153,4	13,6	5	10,44	5	115

PVC-U Druckrohr **PN10** SDR21 grau 5m

PVC-U Pressure pipe **PN10** SDR21 grey 5m

Art Nr	D	e	di	SDR	L	KG	VE1	VE2
Art No	[mm]		[mm]		[m]		PU1	PU2
1111 0850 32	32	1,9	28,2	21	5	0,28	5	1015
1111 0950 32	40	1,9	36,2	21	5	0,36	5	1105
1111 1050 32	50	2,4	45,2	21	5	0,56	5	1075
1111 1150 32	63	3,0	57,0	21	5	0,87	5	545
1111 1250 32	75	3,6	67,8	21	5	1,24	5	500
1111 1350 32	90	4,3	81,4	21	5	1,77	5	370
1111 1950 32	200	9,6	180,8	21	5	8,64	5	115
1111 2050 32	225	10,8	203,4	21	5	10,91	5	55
1111 2150 32	250	11,9	226,2	21	5	13,34	5	55
1111 2250 32	280	13,4	253,2	21	5	16,84	5	40
1111 2350 32	315	15,0	285,0	21	5	21,15	5	40

PVC-U Formteile grau

gespritzt, für Druckrohrleitungen

Werkstoff

PVC-U (Polyvinylchlorid ohne Weichmacher), RAL 7011 Eisengrau. Das Material entspricht den Anforderungen der aktuellen KTW-Leitlinie des Umweltbundesamtes (UBA).

Geometrische Eigenschaften

Kleb- und Gewindeformteile in Anlehnung an DIN EN ISO 1452-3. Erfüllt werden zudem die Anforderungen der DIN CERTCO ZP 12.1.10. Toleranzen bei den Z-Maßangaben sind abhängig von der Dimension. Bis $d/D 160 = \pm 3 \text{ mm}$. Ab $d/D 180 = \pm 10 \text{ mm}$.

Kleb-Verbindung

Kleb- und Übergangsformteile sind geeignet zum Verbinden von PVC-U Röhren, deren Außendurchmesser-Toleranzen der DIN 8062 bzw. ISO 11922-1 entsprechen.

Gewinde-Verbindung

Die Anschlussgewinde der B-R Übergangsformteile mit Verstärkungsring entsprechen den Normen DIN EN 10226 bzw. ISO 7 [Innengewinde (IG) = zylindrisch, Außengewinde (AG) = keglig].

Die Innengewinde der B-R Gewindeformteile ohne Verstärkungsring sind kegelig entsprechend der ISO 7 ausgeführt.

Das Eindichten von PVC-U Gewindeteilen ist ausschließlich mit PTFE-Band vorzunehmen.

Hanf und Dichtpaste sind ungeeignet und dürfen nicht verwendet werden!

Betriebsdruck

Der zulässige Druck ist der jeweiligen Modell-Maßtabelle zu entnehmen. Sofern keine andere Angabe: Richtwert für Klebformteile: PN16 = 16 bar bei 20°C (Wasser).

Richtwert für Übergangs-/Gewindefittings und Verschraubungen: PN10 = 10 bar bei 20°C (Wasser).

Klebstoff

Für die Herstellung von Klebverbindungen ist die Verwendung eines Klebstoffs auf Basis THF unbedingt erforderlich. Unsere diesbezügliche Verlegeanleitung basiert auf der Verwendung von TANGIT-Klebstoff.

Kleblängen

In den Maßtabellen dieses Kataloges sind die Kleblängen nicht gesondert ausgewiesen. Diese sind bei Bedarf generell der nachfolgenden Tabelle zu entnehmen.

Lieferung

Abgabe erfolgt nur in kompletten Verpackungseinheiten (VE's).

PVC-U Fittings grey

injection moulded, for pressure pipe systems

Material

PVC-U (Polyvinyl Chloride unplasticised), RAL 7011 Iron grey. The material complies with the requirements of the KTW guideline of the German Federal Environmental Agency (UBA).

Geometric Properties

Bonding and threaded fittings in accordance to DIN EN ISO 1452-3. Also correspond to DIN CERTCO ZP 12.1.10.

Tolerances of z-sizes depending on the dimension. Up to $d/D 160 = \pm 3 \text{ mm}$ and from $d/D 180 = \pm 10 \text{ mm}$.

Bonding-connection

Solvent cement bonding and adaptor fittings are useable for the connection of PVC-U pipes, with outside diameter tolerances in accordance with DIN 8062 respectively ISO 11922-1.

Threaded-connection

The threaded connection of B-R adaptor fittings with reinforcing ring comply with the requirements of DIN EN 10226 respectively ISO 7 [female-thread = cylindrical, male-thread = conical].

The female threaded fittings without reinforcing ring are conical due to ISO 7 specifications.

The sealing of PVC-U threads is to be performed exclusively with PTFE tape.

Hemp and sealing paste are unsuitable and may not be used!

Working pressure

The admissible pressure has to be used according to the respective measure listing. Unless otherwise stated: Target value for bonding fittings: PN16 = 16 bar at 20°C (water).

Target value for adaptor-/threaded-fittings and unions: PN10 = 10 bar at 20°C (water).

Solvent cement

A cement with gap-filling properties on the basis of THF must be used. Our detailed instructions for solvent connections are based on the use of TANGIT solvent cement.

Length of bonding

The tables in the catalogue do not contain these lengths. Those are contained only in the below shown table.

Delivery

Supply only in complete packing units (PU's).

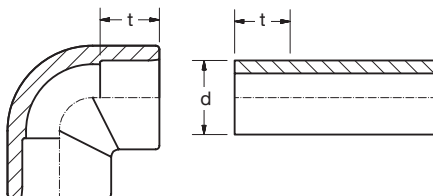

BR PVC-U Muffen-Einstecktiefe

BR- PVC-U socket/pipe length to be entered

d [mm]	t [mm]
10	12
12	12
16	14
20	16
25	19
32	22
40	26
50	31
63	38
75	44
90	51
110	61
140	76
160	86
225	119
250	131
280	146
315	164

1.02.01 Bögen, Winkel • Bends, Elbows

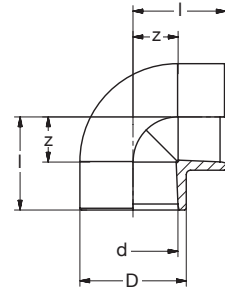
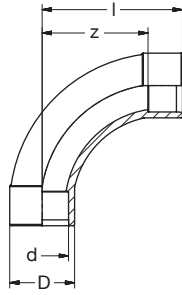

BR PVC-U Bogen 90° grau
BR PVC-U Bend 90° grey

BR PVC-U Winkel 90° grau
BR PVC-U Elbow 90° grey

Art Nr	d	DN	D	l	z	PN	KG	VE1	VE2
Art No	[mm]	[mm]				[bar]		PU1	PU2
1420 0590 12	16	10	23	46	32	16	0,02	10	80
1420 0690 12	20	15	27	56	40	16	0,03	10	80
1420 0790 12	25	20	35	69	50	16	0,05	10	40
1420 0890 12	32	25	40	86	64	16	0,09	5	50
1420 0990 12	40	32	49	106	80	16	0,15	5	30
1420 1090 12	50	40	61	131	100	16	0,27	5	30
1420 1190 12	63	50	76	164	126	16	0,51	2	20
1420 1290 12	75	65	94	190	149	16	1,02	2	8
1420 1390 12	90	80	112	231	180	16	1,79	1	6
1420 1490 12	110	100	137	283	222	16	3,06	1	4
1420 1690 12	140	125	167	355	280	16	5,02	1	2
1420 1790 12	160	150	190	410	319	16	7,41	1	-

Art Nr	d	DN	D	l	z	PN	KG	VE1	VE2
Art No	[mm]	[mm]				[bar]		PU1	PU2
1410 0390 12	10	6	14	18	6	16	0,004	10	300
1410 0490 12	12	8	17	19	7	16	0,005	10	300
1410 0590 12	16	10	23	23	9	16	0,01	10	120
1410 0690 12	20	15	28	27	11	16	0,02	10	120
1410 0790 12	25	20	32	33	14	16	0,03	10	100
1410 0890 12	32	25	40	39	17	16	0,05	10	90
1410 0990 12	40	32	49	49	23	16	0,09	5	50
1410 1090 12	50	40	61	59	27	16	0,16	10	60
1410 1190 12	63	50	75	72	34	16	0,29	5	35
1410 1290 12	75	65	92	82	39	16	0,52	2	24
1410 1390 12	90	80	110	97	46	16	0,70	2	12
1410 1490 12	110	100	132	117	56	16	1,33	2	8
1410 1690 12	140	125	167	147	71	16	2,37	1	4
1410 1790 12	160	150	190	167	81	16	3,73	1	-
1410 2090 32	225	200	256	233	114	10	7,74	1	-
1410 2190 32	250	225	286	317	186	10	9,60	1	-
1410 2290 32	280	250	319	357	210	10	16,4	1	-
1410 2390 32	315	300	360	401	236	10	23,0	1	-

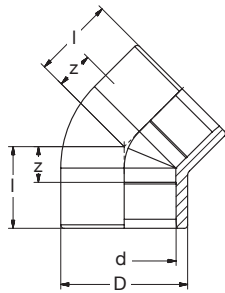

BR PVC-U Winkel 45° grau
BR PVC-U Elbow 45° grey

Art Nr	d	DN	D	l	z	PN	KG	VE1	VE2
Art No	[mm]	[mm]				[bar]		PU1	PU2
1410 0545 12	16	10	23	19	5	16	0,01	10	150
1410 0645 12	20	15	28	21	5	16	0,02	10	160
1410 0745 12	25	20	34	25	6	16	0,03	10	90
1410 0845 12	32	25	41	30	8	16	0,04	10	50
1410 0945 12	40	32	51	36	10	16	0,08	5	30
1410 1045 12	50	40	61	43	12	16	0,12	5	30
1410 1145 12	63	50	77	52	14	16	0,22	5	40
1410 1245 12	75	65	90	60	17	16	0,32	2	12
1410 1345 12	90	80	110	71	20	16	0,64	2	6
1410 1445 12	110	100	132	85	24	16	0,94	2	10
1410 1645 12	140	125	164	105	30	16	1,59	1	-
1410 1745 12	160	150	188	120	34	16	2,47	1	4
1410 2045 12	225	200	259	172	49	10	5,53	1	-
1410 2145 32	250	225	287	190	58	10	7,70	1	-
1410 2245 32	280	250	320	208	62	10	10,4	1	-
1410 2345 32	315	300	360	232	68	10	13,7	1	-



1.02.02 T-Stücke, Abzweige • Tee's, Branches

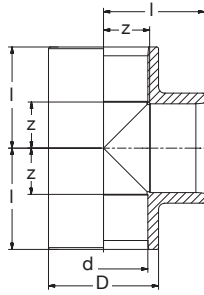

BR PVC-U T-Stück 90° grau

BR PVC-U Tee 90° grey

Art Nr	d	DN	D	l	z	PN		VE1	VE2
Art No	[mm]		[mm]			[bar]		PU1	PU2
1510 0390 32	10	6	16	19	6	16	0,010	10	140
1510 0490 32	12	8	19	20	7	16	0,010	10	100
1510 0590 12	16	10	23	23	9	16	0,016	10	100
1510 0690 12	20	15	28	27	11	16	0,021	10	100
1510 0790 12	25	20	34	33	14	16	0,036	10	60
1510 0890 12	32	25	41	39	17	16	0,061	10	80
1510 0990 12	40	32	49	47	21	16	0,12	5	40
1510 1090 12	50	40	62	58	27	16	0,21	10	40
1510 1190 12	63	50	77	72	34	16	0,38	5	30
1510 1290 12	75	65	92	84	39	16	0,67	2	16
1510 1390 12	90	80	110	97	46	16	0,96	2	8
1510 1490 12	110	100	132	117	56	16	1,70	2	8
1510 1690 12	140	125	170	149	73	16	3,58	1	-
1510 1790 12	160	150	191	169	83	16	4,64	1	-
1510 2090 12	225	200	256	233	114	10	10,1	1	-
1510 2190 32	250	225	286	261	132	10	13,2	1	-
1510 2290 32	280	250	319	290	144	10	18,1	1	-
1510 2390 32	315	300	360	326	162	10	24,4	1	-

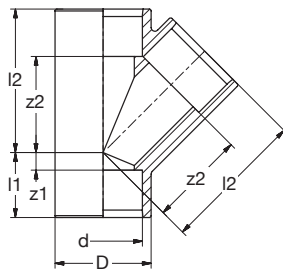

BR PVC-U Abzweig 45° grau

BR PVC-U Branch 45° grey

Art Nr	d	DN	D	l1	l2	z1	z2	PN		VE1	VE2
Art No	[mm]		[mm]					[bar]		PU1	PU2
1510 0645 32	20	15	28	23	47	5	30	10	0,040	10	-
1510 0745 32	25	20	33	28	56	6	37	10	0,060	10	50
1510 0845 12	32	25	41	29	61	7	39	10	0,086	10	50
1510 0945 12	40	32	51	35	75	9	49	10	0,19	10	30
1510 1045 12	50	40	63	42	92	11	61	10	0,34	5	15
1510 1145 12	63	50	77	52	115	14	77	10	0,51	5	10
1510 1245 12	75	65	90	63	144	19	100	6	0,87	2	10
1510 1345 32	90	80	107	70	175	19	116	6	1,25	1	4
1510 1445 12	110	100	136	88	210	27	148	6	2,81	1	4

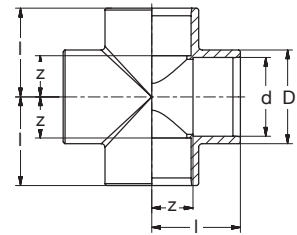

BR PVC-U Kreuz grau

BR PVC-U Cross grey

Art Nr	d	DN	D	l	z	PN		VE1	VE2
Art No	[mm]		[mm]			[bar]		PU1	PU2
1550 0700 32	25	20	34	32	14	16	0,049	10	40
1550 0800 12	32	25	40	39	17	16	0,068	10	50
1550 0900 12	40	32	51	47	21	16	0,15	10	40
1550 1000 12	50	40	63	57	26	16	0,26	10	30
1550 1100 12	63	50	77	72	34	16	0,46	5	15

1.02.02 T-Stücke, Abzweige • Tee's, Branches

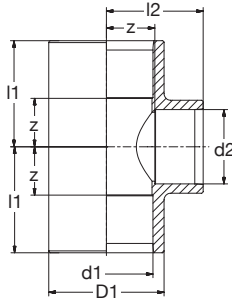

BR PVC-U T-Stück 90° red grau

BR PVC-U Tee 90° red grey

Art Nr	d1-d2	DN1-DN2	D1	l1	l2	z	PN	KG	VE1	VE2
Art No	[mm]		[mm]				[bar]		PU1	PU2
1520 0706 12	25-20	20-15	33	33	30	14	16	0,046	10	60
1520 0806 22	32-20	25-15	41	39	33	17	16	0,072	10	80
1520 0807 22	32-25	25-20	41	39	36	17	16	0,066	10	80
1520 0906 12	40-20	32-15	50	49	39	24	16	0,11	10	40
1520 0907 12	40-25	32-20	50	49	42	24	16	0,11	10	40
1520 0908 22	40-32	32-25	50	49	45	24	16	0,10	10	40
1520 1006 12	50-20	40-15	62	58	48	27	16	0,20	10	40
1520 1007 12	50-25	40-20	62	58	48	27	16	0,20	10	40
1520 1008 12	50-32	40-25	62	58	48	27	16	0,18	10	40
1520 1009 12	50-40	40-32	62	58	58	27	16	0,25	10	40
1520 1106 12	63-20	50-15	75	71	51	33	16	0,29	5	15
1520 1107 12	63-25	50-20	75	71	53	33	16	0,29	5	15
1520 1108 12	63-32	50-25	75	71	56	33	16	0,29	5	15
1520 1109 12	63-40	50-32	75	71	60	33	16	0,29	5	20
1520 1110 12	63-50	50-40	75	71	65	33	16	0,29	5	15
1520 1210 32	75-50	65-40	92	84	72	39	16	0,51	5	-
1520 1211 32	75-63	65-50	92	84	79	39	16	0,56	5	-
1520 1311 32	90-63	80-50	110	97	93	46	16	0,89	1	-
1520 1312 32	90-75	80-65	110	97	99	46	16	0,89	1	-
1520 1413 32	110-90	100-80	132	117	116	56	16	1,50	1	-
1520 1714 32	160-110	150-100	191	169	142	83	16	4,10	1	-
1520 2017 32	225-160	200-150	256	233	205	114	10	10,0	1	-

1.02.03 Reduktionen, Muffen, Kappen • Reducers, Sockets, Caps

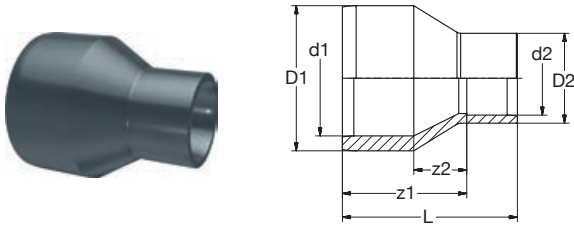

BR PVC-U Reduktion lang grau

BR PVC-U Reducer long grey

Art Nr	d1-d2	d1-d2	d1-D2	D1-D2	DN1	DN2	D2	L	z1	z2	PN	KG	VE1	VE2
Art No	[mm]	[mm]										[bar]	PU1	PU2
1321 0403 32	12-10	8-10			8	6	13	27	15	3	16	0,004	10	-
1321 0503 32	16-10	12-10	12-16	16-16	10	6	16	30	18	6	16	0,010	10	-
1321 0604 32	20-12	16-12	16-16	20-16	15	8	16	33	22	7	16	0,010	10	150
1321 0605 12	20-16				15	10	22	34	20		16	0,009	10	150
1321 0704 32	25-12	20-12	20-16	25-16	20	8	16	38	25	10	16	0,010	10	-
1321 0705 12	25-16				20	10	22	39	25		16	0,011	10	200
1321 0706 12	25-20				20	15	26	40	24		16	0,012	10	120
1321 0805 12	32-16	25-16			25	10	22	44	30	11	16	0,016	10	90
1321 0806 12	32-20	25-20			25	15	26	46	30	11	16	0,017	10	90
1321 0807 12	32-25				25	20	31	48	30		16	0,021	10	90
1321 0905 12	40-16	32-16			32	10	22	50	36	14	16	0,025	10	60
1321 0906 12	40-20	32-20			32	15	26	52	36	14	16	0,029	10	60
1321 0907 12	40-25	32-25			32	20	31	55	36	14	16	0,029	10	60
1321 0908 12	40-32				32	25	39	59	37	14	16	0,035	10	60
1321 1006 12	50-20	40-20			40	15	26	60	44	18	16	0,052	10	50
1321 1007 12	50-25	40-25			40	20	32	62	44	18	16	0,052	10	50
1321 1008 12	50-32	40-32			40	25	39	66	44	18	16	0,060	10	40
1321 1009 12	50-40				40	32	48	70	44		16	0,082	10	30
1321 1107 12	63-25	50-25			50	20	32	73	54	23	16	0,085	5	40
1321 1108 12	63-32	50-32			50	25	39	76	54	23	16	0,092	5	40
1321 1109 12	63-40	50-40			50	32	48	80	54	23	16	0,099	5	40
1321 1110 12	63-50				50	40	60	85	54		16	0,10	5	40
1321 1208 32	75-32	63-32	63-40	75-40	65	25	40	85	62	25	16	0,14	5	-
1321 1209 32	75-40	63-40	63-50	75-50	65	32	50	88	62	24	16	0,15	5	-
1321 1210 32	75-50	63-50	63-63	75-63	65	40	63	93	62	24	16	0,17	5	-
1321 1211 32	75-63	63-63			65	50	75	101	62	25	16	0,21	5	-
1321 1309 32	90-40	75-40	75-50	90-50	80	32	50	101	74	31	16	0,23	5	-
1321 1310 32	90-50	75-50	75-63	90-63	80	40	63	105	74	30	16	0,24	5	-
1321 1311 32	90-63	75-63	75-75	90-75	80	50	75	113	74	31	16	0,28	5	-
1321 1312 32	90-75	75-75			80	65	90	119	74	31	16	0,34	5	-
1321 1614 32	140-110				125	100	126	172	110		16	0,83	1	-

D1-d2 Maße = Rohr-Muffe Sizes = Pipe-Socket
d1-d2 Maße = Muffe-Muffe Sizes = Socket-Socket
d1-D2 Maße = Muffe-Rohr Sizes = Socket-Pipe
D1-D2 Maße = Rohr-Rohr Sizes = Pipe-Pipe

1.02.03 Reduktionen, Muffen, Kappen • Reducers, Sockets, Caps

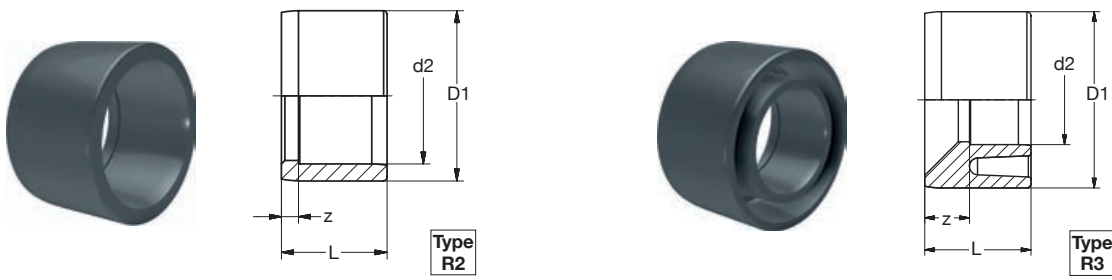

BR PVC-U Reduktion kurz grau
BR PVC-U Reducer short grey

Art Nr Art No	D1-d2 [mm]	DN1-DN2 [mm]	Type		L [mm]	z	PN [bar]		VE1	VE2
			R2	R3					PU1	PU2
1322 0504 12	16-12	10-8	•		14	2	16	0,002	10	1000
1322 0605 12	20-16	15-10	•		16	2	16	0,003	10	500
1322 0705 12	25-16	20-10	•		19	5	16	0,008	10	300
1322 0706 12	25-20	20-15	•		19	3	16	0,005	10	200
1322 0805 12	32-16	25-10	•		22	8	16	0,014	10	150
1322 0806 12	32-20	25-15	•		22	6	16	0,015	10	140
1322 0807 12	32-25	25-20	•		22	3	16	0,009	10	140
1322 0905 12	40-16	32-10	•		26	12	16	0,021	10	120
1322 0906 12	40-20	32-15	•		26	10	16	0,023	10	120
1322 0907 12	40-25	32-20	•		26	7	16	0,021	10	120
1322 0908 12	40-32	32-25	•		26	4	16	0,016	10	120
1322 1006 12	50-20	40-15	•		31	15	16	0,040	10	80
1322 1007 12	50-25	40-20	•		31	12	16	0,041	10	80
1322 1008 12	50-32	40-25	•		31	9	16	0,039	10	80
1322 1009 12	50-40	40-32	•		31	5	16	0,029	10	80
1322 1107 12	63-25	50-20	•		38	19	16	0,083	10	70
1322 1108 12	63-32	50-25	•		38	16	16	0,077	10	70
1322 1109 12	63-40	50-32	•		38	12	16	0,073	10	70
1322 1110 12	63-50	50-40	•		38	7	16	0,062	10	70
1322 1208 12	75-32	65-25	•		44	21	16	0,11	10	60
1322 1209 12	75-40	65-32	•		44	17	16	0,11	10	60
1322 1210 12	75-50	65-40	•		44	13	16	0,11	10	60
1322 1211 12	75-63	65-50	•		44	7	16	0,085	10	60
1322 1309 12	90-40	80-32	•		51	25	16	0,18	2	40
1322 1310 12	90-50	80-40	•		51	20	16	0,18	2	40
1322 1311 12	90-63	80-50	•		51	13	16	0,18	2	40
1322 1312 12	90-75	80-65	•		51	8	16	0,14	2	40
1322 1410 12	110-50	100-40	•		61	31	16	0,30	2	20
1322 1411 12	110-63	100-50	•		61	24	16	0,31	2	20
1322 1412 12	110-75	100-65	•		61	17	16	0,31	2	18
1322 1413 12	110-90	100-80	•		61	10	16	0,26	2	18
1322 1514 32	125-110	100-100	•		69	8	16	0,26	2	18
1322 1612 12	140-75	125-65	•		76	32	16	0,62	2	20
1322 1613 12	140-90	125-80	•		76	25	16	0,62	2	20
1322 1614 12	140-110	125-100	•		76	15	16	0,60	2	20
1322 1615 32	140-125	125-100	•		76	7	16	0,33	2	20
1322 1713 12	160-90	150-80	•		86	34	16	0,84	2	6
1322 1714 12	160-110	150-100	•		86	24	16	0,86	2	6
1322 1716 12	160-140	150-125	•		86	10	16	0,57	2	6
1322 1917 32	200-160	180-150	•		106	20	10	1,67	1	3
1322 2017 12	225-160	200-150	•		119	33	10	2,19	1	3
1322 2019 32	225-200	200-180	•		119	33	10	1,70	1	-
1322 2120 32	250-225	225-200	•		132	12	10	4,44	1	-
1322 2220 32	280-225	250-200	•		146	27	10	4,70	1	-
1322 2221 32	280-250	250-225	•		146	15	10	5,68	1	-
1322 2320 32	315-225	300-200	•		163	45	10	6,52	1	-
1322 2321 32	315-250	300-225	•		164	33	10	6,49	1	-
1322 2322 32	315-280	300-250	•		163	17	10	6,70	1	-

1.02.03 Reduktionen, Muffen, Kappen • Reducers, Sockets, Caps

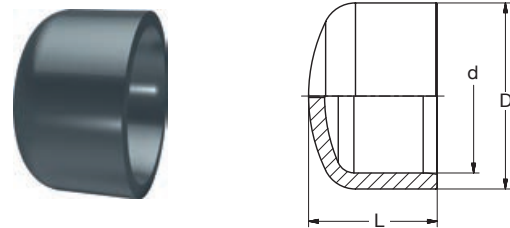
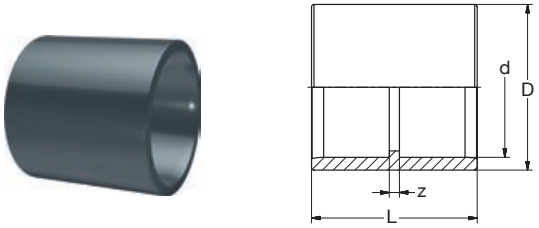

BR PVC-U Muffe grau
BR PVC-U Socket grey

Art Nr	d	DN	D	L	z	PN		VE1	VE2
Art No	[mm]		[mm]			[bar]	KG	PU1	PU2
1310 0200 32	8	5	14	28	3	16	0,004	A	-
1310 0300 32	10	6	16	28	3	16	0,010	10	-
1310 0400 32	12	8	19	28	3	16	0,010	10	-
1310 0500 12	16	10	22	32	3	16	0,008	10	200
1310 0600 12	20	15	26	34	3	16	0,011	10	200
1310 0700 12	25	20	31	40	3	16	0,015	10	140
1310 0800 12	32	25	39	47	3	16	0,022	10	70
1310 0900 12	40	32	48	56	4	16	0,037	10	80
1310 1000 12	50	40	60	66	4	16	0,070	10	60
1310 1100 12	63	50	75	80	4	16	0,14	5	30
1310 1200 12	75	65	89	96	8	16	0,54	2	20
1310 1300 12	90	80	107	108	4	16	0,38	2	12
1310 1400 12	110	100	130	130	8	16	0,63	2	18
1310 1600 12	140	125	163	160	8	16	1,21	1	8
1310 1700 12	160	150	186	182	8	16	1,81	1	2
1310 2000 12	225	200	260	248	12	10	3,41	1	-
1310 2100 32	250	225	287	282	14	10	5,70	1	-
1310 2200 32	280	250	320	314	18	10	7,30	1	-
1310 2300 32	315	300	355	348	14	10	9,20	1	-

BR PVC-U Kappe grau
BR PVC-U Cap grey

Art Nr	d	DN	D	L	PN		VE1	VE2
Art No	[mm]		[mm]		[bar]	KG	PU1	PU2
1340 0400 32	12	8	21	16	16	0,008	10	-
1340 0500 12	16	10	23	20	16	0,006	10	250
1340 0600 12	20	15	28	23	16	0,009	10	200
1340 0700 12	25	20	34	26	16	0,014	10	120
1340 0800 12	32	25	41	32	16	0,023	10	120
1340 0900 12	40	32	52	39	16	0,046	10	80
1340 1000 12	50	40	63	48	16	0,077	10	70
1340 1100 12	63	50	77	56	16	0,12	5	120
1340 1200 12	75	65	90	66	10	0,19	2	16
1340 1300 12	90	80	110	77	10	0,34	2	16
1340 1400 12	110	100	133	92	6	0,62	2	8
1340 1600 12	140	125	161	121	6	0,94	1	5
1340 1700 12	160	150	185	136	4	1,48	1	8
1340 2000 12	225	200	260	174	4	3,44	1	2

1.02.04 Übergänge • Transitions

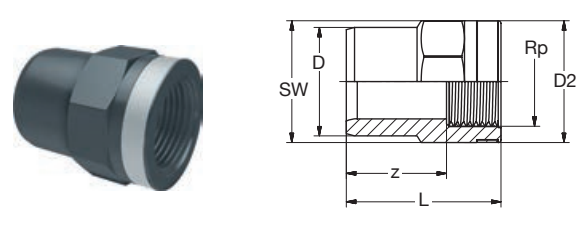
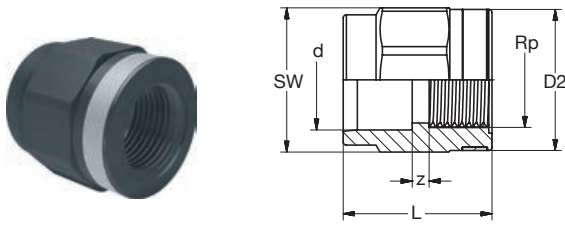

BR PVC-U Übergang IG-zyl grau
BR PVC-U Transition female-thread-cyl grey

Art Nr Art No	d x Rp [mm x Inch]	DN	D2	L	z	SW	PN [bar]	KG	VE1 PU1	VE2 PU2
161M 0441 32	12 x 1/4	8	20	27	4	22	10	0,010	10	-
161M 0542 12	16 x 3/8	10	25	30	5	27	10	0,016	10	150
161M 0643 12	20 x 1/2	15	30	36	5	30	10	0,025	10	150
161M 0745 12	25 x 3/4	20	35	40	5	36	10	0,032	10	100
161M 0846 12	32 x 1	25	45	47	5	46	10	0,056	10	60
161M 0947 12	40 x 1 1/4	32	55	52	5	55	10	0,090	10	80
161M 1048 12	50 x 1 1/2	40	65	60	7	65	10	0,15	10	60
161M 1150 12	63 x 2	50	75	72	7	80	10	0,22	5	75
161M 1253 22	75 x 2 1/2	65	89	92	18	90	10	0,31	5	-
161M 1355 22	90 x 3	80	107	107	23	108	10	0,52	5	-
161M 1457 32	110 x 4	100	130	128	28	131	10	0,74	5	-

Anschluss an Metall- oder Kunststoffgewinde.
Connection to metal or plastic thread.

BR PVC-U Ü-Reduktion IG-zyl grau
BR PVC-U Transition-Reducer female-thread-cyl grey

Art Nr Art No	D x Rp [mm x Inch]	DN	D2	L	z	SW	PN [bar]	KG	VE1 PU1	VE2 PU2
163M 0441 32	12 x 1/4	8	20	27	17	22	10	0,010	10	-
163M 0642 12	20 x 3/8	15	25	35	24	27	10	0,016	10	150
163M 0743 12	25 x 1/2	20	30	42	27	32	10	0,025	10	150
163M 0845 12	32 x 3/4	25	35	48	32	36	10	0,037	10	80
163M 0946 12	40 x 1	32	45	56	36	46	10	0,069	10	50
163M 1047 12	50 x 1 1/4	40	55	66	46	55	10	0,12	10	60
163M 1148 12	63 x 1 1/2	50	65	77	55	65	5	0,18	5	40

Anschluss an Metall- oder Kunststoffgewinde.
Connection to metal or plastic thread.

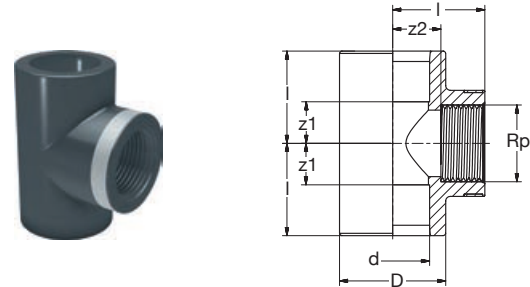
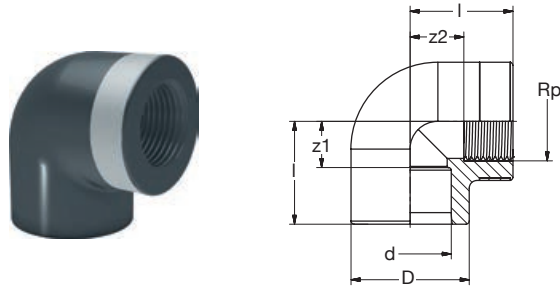

BR PVC-U Ü-Winkel 90° IG-zyl grau
BR PVC-U Transition-Elbow 90° female-thread-cyl grey

Art Nr Art No	d x Rp [mm x Inch]	DN	D	l	z1	z2	PN [bar]	KG	VE1 PU1	VE2 PU2
162M 0441 32	12 x 1/4	8	20	19	7	8	10	0,010	10	-
162M 0542 32	16 x 3/8	10	25	23	9	12	10	0,020	10	-
162M 0643 12	20 x 1/2	15	30	28	12	14	10	0,033	10	120
162M 0745 12	25 x 3/4	20	36	34	14	17	10	0,050	10	60
162M 0846 12	32 x 1	25	47	40	17	22	10	0,096	10	30
162M 0947 12	40 x 1 1/4	32	55	49	22	28	10	0,17	10	90
162M 1048 12	50 x 1 1/2	40	65	59	27	38	10	0,27	10	20
162M 1150 32	63 x 2	50	75	71	33	46	10	0,29	5	-

Anschluss an Metall- oder Kunststoffgewinde.
Connection to metal or plastic thread.

BR PVC-U Ü-T-Stück 90° IG-zyl grau
BR PVC-U Transition-Tee 90° female-thread-cyl grey

Art Nr Art No	d x Rp [mm x Inch]	DN	D	l	z1	z2	PN [bar]	KG	VE1 PU1	VE2 PU2
164M 0441 32	12 x 1/4	8	20	19	7	8	10	0,020	10	-
164M 0542 32	16 x 3/8	10	25	23	9	12	10	0,030	10	-
164M 0643 12	20 x 1/2	15	30	28	12	14	10	0,040	10	80
164M 0745 12	25 x 3/4	20	36	33	14	17	10	0,062	10	50
164M 0846 12	32 x 1	25	47	40	18	22	10	0,13	10	20
164M 0947 12	40 x 1 1/4	32	55	49	22	28	10	0,21	10	30
164M 1048 12	50 x 1 1/2	40	65	59	27	38	10	0,31	10	20
164M 1150 32	63 x 2	50	75	71	33	46	10	0,41	5	-

Anschluss an Metall- oder Kunststoffgewinde.
Connection to metal or plastic thread.

1.02.04 Übergänge • Transitions

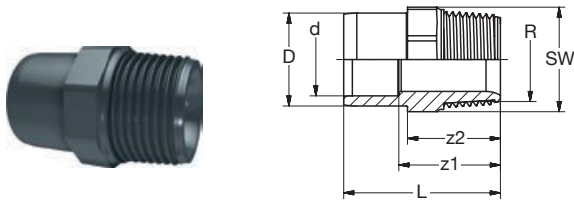

BR PVC-U Ü-Reduktion/Muffe **AG-keg** grau

BR PVC-U Transition-Reducer/Socket male-thread-con grey

Art Nr	D / d x R	DN / DN	L	z1	z2	SW	PN	KG	VE1	VE2
Art No	[mm x Inch]		[mm]				[bar]		PU1	PU2
1610 0572 12	16 / 12 x 3/8	10 / 8	35	23	21	22	10	0,010	10	150
1610 0672 12	20 / 16 x 3/8	15 / 10	37	23	21	27	10	0,010	10	150
1610 0673 12	20 / 16 x 1/2	15 / 10	42	28	26	24	10	0,012	10	160
1610 0773 12	25 / 20 x 1/2	20 / 15	45	29	26	30	10	0,017	10	130
1610 0775 12	25 / 20 x 3/4	20 / 15	47	31	28	30	10	0,019	10	100
1610 0875 12	32 / 25 x 3/4	25 / 20	50	31	28	36	10	0,028	10	100
1610 0876 12	32 / 25 x 1	25 / 20	54	35	32	36	10	0,031	10	50
1610 0976 12	40 / 32 x 1	32 / 25	58	36	32	46	10	0,044	10	60
1610 0977 12	40 / 32 x 1 1/4	32 / 25	60	38	34	46	10	0,049	10	100
1610 1077 12	50 / 40 x 1 1/4	40 / 32	65	39	34	55	10	0,069	10	60
1610 1078 12	50 / 40 x 1 1/2	40 / 32	65	41	35	55	10	0,075	10	70
1610 1178 12	63 / 50 x 1 1/2	50 / 40	73	42	35	65	10	0,12	5	60
1610 1180 12	63 / 50 x 2	50 / 40	78	47	40	65	10	0,14	5	60
1610 1280 12	75 / 63 x 2	65 / 50	84	46	40	80	10	0,17	5	60

Anschluss an Kunststoffgewinde.
Connection to plastic thread.

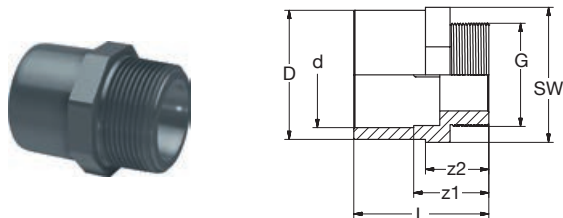

BR PVC-U Ü-Reduktion/Muffe **AG-zyl** grau

BR PVC-U Transition-Reducer/Socket male-thread-cyl grey

Art Nr	D / d x G	DN / DN	L	z1	z2	SW	PN	KG	VE1	VE2
Art No	[mm x Inch]		[mm]				[bar]		PU1	PU2
1610 1383 32	90 / 75 x 2 1/2	80 / 65	99	55	48	95	10	0,31	2	32
1610 1485 32	110 / 90 x 3	100 / 80	113	62	52	115	10	0,44	2	18
1610 1587 32	125 / 110 x 4	100 / 100	120	59	54	130	10	0,71	1	12

Anschluss an Kunststoffgewinde.
Connection to plastic thread.

1.02.04 Übergänge • Transitions

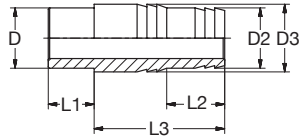

BR PVC-U Druckschlauchtülle grau

BR PVC-U Hose nozzle grey

Art Nr	D	D2	D3	L1	L2	L3	PN	KG	VE1	VE2
Art No	[mm]			[mm]			[bar]		PU1	PU2
1380 0300 12	10	10	-	12	-	39	10	0,002	10	3000
1380 0400 12	12	12	-	12	-	39	10	0,004	10	1800
1380 0500 32	16	16	18	14	18	40	10	0,010	10	1000
1380 0600 32	20	20	22	16	20	44	10	0,015	10	600
1380 0700 32	25	25	28	19	24	54	10	0,020	10	450
1380 0800 32	32	31	34	22	28	63	10	0,044	10	250
1380 0900 32	40	40	43	26	32	72	10	0,060	10	200
1380 1000 32	50	50	53	31	35	80	10	0,11	10	120
1380 1100 32	63	60	66	38	40	90	10	0,15	10	60

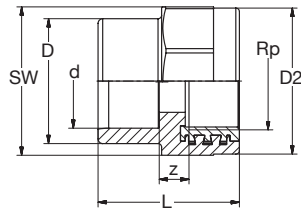

BR PVC-U-RG Übergang IG-zyl grau

BR PVC-U-Bronze Transition female-thread-cyl grey

Art Nr	d x Rp	DN	D	D2	L	z	SW	PN	KG	VE1	VE2
Art No	[mm x Inch]				[mm]			[bar]		PU1	PU2
1R10 0643 12	20 x 1/2	15	29	35	40	10	36	16	0,076	10	100
1R10 0745 12	25 x 3/4	20	34	43	42	8	44	16	0,12	10	50
1R10 0846 12	32 x 1	25	43	50	52	12	51	16	0,18	10	50
1R10 0947 12	40 x 1 1/4	32	52	62	59	13	63	16	0,26	10	36
1R10 1048 12	50 x 1 1/2	40	64	69	65	14	70	16	0,30	2	24
1R10 1150 12	63 x 2	50	79	84	78	19	85	16	0,57	2	12

1.02.04 Übergänge • Transitions

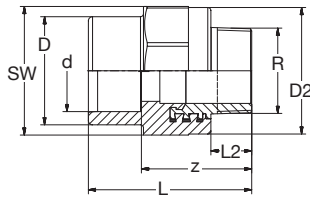

BR PVC-U-RG Übergang AG-keg grau

BR PVC-U-Bronze Transition male-thread-con grey

Art Nr	d x R	DN	D	D2	L	L2	z	SW	PN	KG	VE1	VE2
Art No	[mm x Inch]	[mm]							[bar]		PU1	PU2
1R10 0673 12	20 x 1/2	15	29	35	55	13	39	36	16	0,10	10	90
1R10 0775 12	25 x 3/4	20	34	43	58	14	39	44	16	0,14	10	50
1R10 0876 12	32 x 1	25	43	50	70	16	48	51	16	0,23	10	40
1R10 0977 12	40 x 1 1/4	32	52	62	79	20	53	63	16	0,36	2	24
1R10 1078 12	50 x 1 1/2	40	64	69	85	20	54	70	16	0,42	2	16
1R10 1180 12	63 x 2	50	79	84	103	23	65	85	16	0,73	2	12

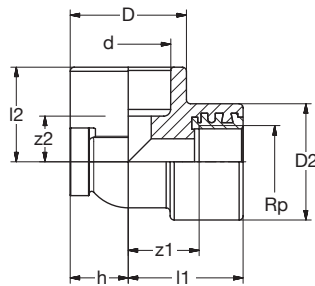
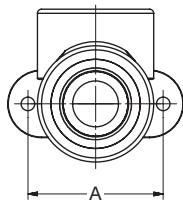

BR PVC-U-RG Ü-Winkel 90° IG-zyl Wandbefestigung grau

BR PVC-U-Bronze Transition-Elbow 90° female-thread-cyl wall-mount grey

Art Nr	d x Rp	DN	D	D2	L1	L2	h	A*	z1	z2	PN	KG	VE1	VE2	
Art No	[mm x Inch]	[mm]										[bar]		PU1	PU2
1R30 0643 12	20 x 1/2	15	29	35	35	27	15	40	21	11	16	0,12	1	50	
1R30 0745 12	25 x 3/4	20	43	43	43	35	22	50	28	19	16	0,18	1	30	

* Abstand der Befestigungslöcher • Distance of mounting holes.

1.02.05 Verschraubungen • Unions

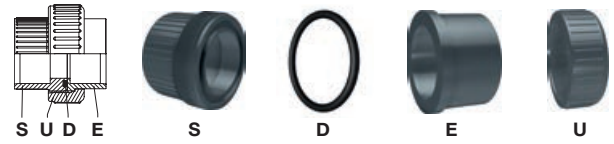
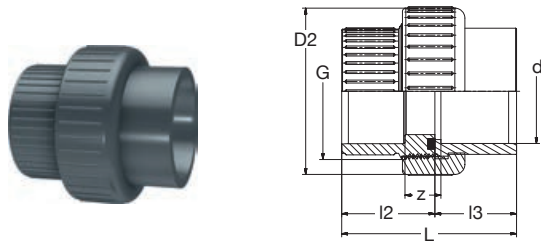

BR PVC-U Verschraubung Runddichtring-EPDM grau
BR PVC-U Union O-Ring-gasket-EPDM grey

Art Nr	d	DN	G	D2	L	l2	l3	z	PN	KG	VE1	VE2
Art No	[mm]	[mm]	[Inch]	[mm]					[bar]		PU1	PU2
1350 0300 32	10	6	5/8	31	37	15	22	13	10	0,020	10	-
1350 0400 32	12	8	5/8	31	37	15	22	13	10	0,020	10	-
1350 0500 12	16	10	3/4	35	41	17	24	13	10	0,024	10	140
1350 0600 12	20	15	1	43	46	19	26	13	10	0,039	10	80
1350 0700 12	25	20	1 1/4	53	52	22	30	13	10	0,064	10	90
1350 0800 12	32	25	1 1/2	60	57	25	32	13	10	0,085	10	60
1350 0900 12	40	32	2	74	68	30	38	15	10	0,15	10	40
1350 1000 12	50	40	2 1/4	83	79	35	44	17	10	0,20	10	60
1350 1100 12	63	50	2 3/4	103	97	41	55	21	10	0,35	2	30
1350 1200 12	75	65	3 1/2	122	108	47	61	20	10	0,58	2	18
1350 1300 12	90	80	4	139	124	56	68	22	6	0,75	1	18
1350 1400 12	110	100	5	164	138	66	72	16	6	1,15	1	8

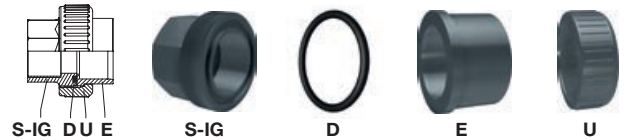
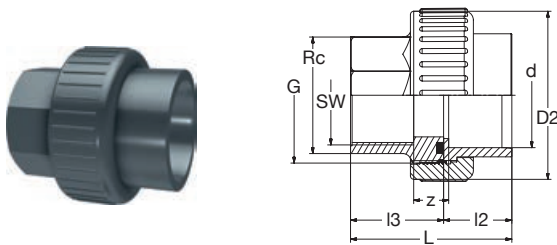

BR PVC-U Ü-Verschraubung IG-keg Runddichtring-EPDM grau
BR PVC-U Transition-Union female-thread-con O-Ring-gasket-EPDM grey

Art Nr	d x Rc	DN	G	D2	L	l2	l3	z	SW	PN	KG	VE1	VE2
Art No	[mm x Inch]	[mm]	[Zoll/Inch]	[mm]					[bar]		PU1	PU2	
1650 0542 12	16 x 3/8	10	3/4	35	41	17	24	16	22	10	0,024	1	-
1650 0643 12	20 x 1/2	15	1	43	45	19	26	16	27	10	0,039	1	-
1650 0745 12	25 x 3/4	20	1 1/4	53	51	22	29	16	36	10	0,064	1	-
1650 0846 12	32 x 1	25	1 1/2	60	57	25	32	16	41	10	0,085	1	-
1650 0947 12	40 x 1 1/4	32	2	74	67	29	38	20	50	10	0,15	1	-
1650 1048 12	50 x 1 1/2	40	2 1/4	83	79	34	45	27	60	10	0,20	1	-
1650 1150 12	63 x 2	50	2 3/4	103	97	41	56	34	70	10	0,35	1	-

1.02.05 Verschraubungen • Unions

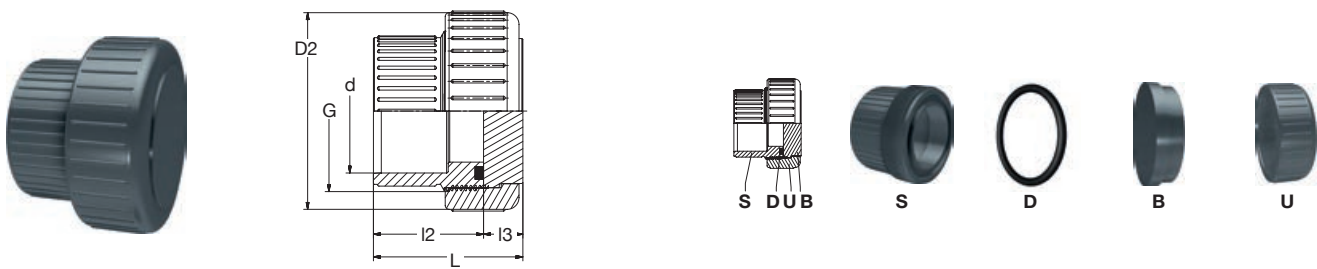

BR PVC-U Verschraubung mit Blindteil Runddichtring-EPDM grau
BR PVC-U Union with blind-part O-Ring-gasket-EPDM grey

Art Nr	d	DN	D2	G	L	l2	l3	PN	KG	VE1	VE2
Art No	[mm]	[mm]	[mm]	[Inch]	[mm]	[mm]	[mm]	[bar]		PU1	PU2
135B 0600 12	20	15	43	1	38	12	26	10	0,038	1	-
135B 0700 12	25	20	53	1 1/4	45	15	30	10	0,068	1	-
135B 0800 12	32	25	60	1 1/2	47	15	32	10	0,097	1	-
135B 0900 12	40	32	74	2	55	17	38	10	0,16	1	-
135B 1000 12	50	40	83	2 1/4	61	17	44	10	0,22	1	-
135B 1100 12	63	50	103	2 1/2	75	20	55	10	0,39	1	-

Einzelteile Verschraubungen • Spare parts Unions

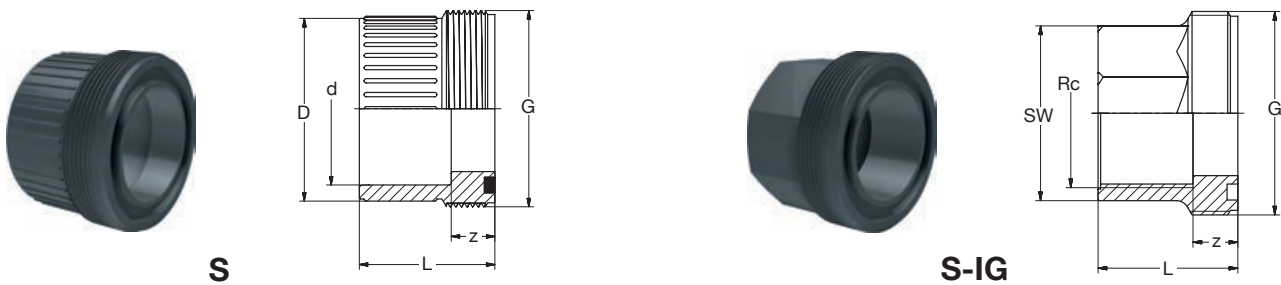

BR PVC-U Verschraubung Schraubteil grau
BR PVC-U Union Screw-part grey

Art Nr	d	DN	G	D	L	z	PN	KG	VE1	VE2
Art No	[mm]	[mm]	[Inch]	[mm]	[mm]	[mm]	[bar]		PU1	PU2
1350 03S0 32	10	6	5/8	20	23	10	10	0,010	10	-
1350 04S0 32	12	8	5/8	20	23	10	10	0,010	10	-
1350 05S0 12	16	10	3/4	23	24	10	10	0,008	50	1500
1350 06S0 12	20	15	1	28	26	10	10	0,013	50	1000
1350 07S0 12	25	20	1 1/4	33	29	10	10	0,020	50	650
1350 08S0 12	32	25	1 1/2	40	31	10	10	0,027	50	400
1350 09S0 12	40	32	2	50	38	12	10	0,032	25	200
1350 10S0 12	50	40	2 1/4	61	44	14	10	0,062	1	180
1350 11S0 12	63	50	2 3/4	76	55	18	10	0,12	1	80
1350 12S0 12	75	65	3 1/2	96	61	17	10	0,22	1	50
1350 13S0 12	90	80	4	109	68	17	6	0,27	1	40
1350 14S0 12	110	100	5	133	72	11	6	0,41	1	30

BR PVC-U Verschraubung Schraubteil IG-keg grau
BR PVC-U Union Screw-part female-thread-con grey

Art Nr	Rc	G	L	z	SW	PN	KG	VE1	VE2
Art No	[Inch]	[Inch]	[mm]	[mm]	[mm]	[bar]		PU1	PU2
1650 42S0 12	3/8	3/4	24	10	22	10	0,009	1	250
1650 43S0 12	1/2	1	26	10	27	10	0,013	1	1000
1650 45S0 12	3/4	1 1/4	29	10	36	10	0,026	1	600
1650 46S0 12	1	1 1/2	32	10	41	10	0,031	1	200
1650 47S0 12	1 1/4	2	38	10	50	10	0,059	1	200
1650 48S0 12	1 1/2	2 1/4	45	10	60	10	0,089	1	150
1650 50S0 12	2	2 3/4	56	12	70	10	0,15	1	90

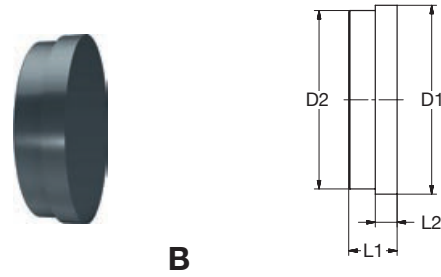
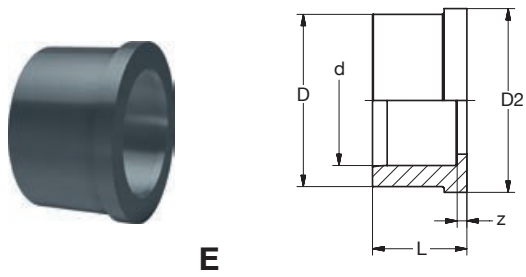

BR PVC-U Verschraubung Einleitteil grau
BR PVC-U Union Insert-part grey

BR PVC-U Verschraubung Blindteil grau
BR PVC-U Union Blind-part grey

Art Nr Art No	d [mm]	DN	D	D2	L	z	PN [bar]	KG	VE1 PU1	VE2 PU2
1350 03E0 32	10	6	19,0	20,0	15	3	10	0,004	10	-
1350 04E0 32	12	8	19,0	20,0	15	3	10	0,004	10	-
1350 05E0 12	16	10	22,0	24,0	17	3	10	0,005	50	1200
1350 06E0 12	20	15	27,5	30,1	19	3	10	0,008	50	700
1350 07E0 12	25	20	36,0	38,8	22	3	10	0,015	50	400
1350 08E0 12	32	25	41,5	44,7	25	3	10	0,020	50	500
1350 09E0 12	40	32	53,0	56,5	29	3	10	0,032	25	300
1350 10E0 12	50	40	59,0	62,6	34	3	10	0,040	1	250
1350 11E0 12	63	50	74,0	78,4	41	3	10	0,073	1	130
1350 12E0 12	75	65	92,5	97,2	47	3	10	0,16	1	70
1350 13E0 12	90	80	105,0	110,0	56	5	6	0,19	1	50
1350 14E0 12	110	100	129,0	134,4	66	5	6	0,34	1	30

Art Nr Art No	d [mm]	DN	D1	D2	L1	L2	PN [bar]	KG	VE1 PU1	VE2 PU2
1350 06B0 02	20	15	30,0	27,5	12	5,5	10	0,010	1	-
1350 07B0 02	25	20	39,0	36,0	15	7,0	10	0,017	1	-
1350 08B0 02	32	25	44,3	41,2	15	6,8	10	0,025	1	-
1350 09B0 02	40	32	56,0	53,0	17	8,0	10	0,043	1	-
1350 10B0 02	50	40	62,5	59,0	17	7,0	10	0,062	1	-
1350 11B0 02	63	50	78,0	73,7	20	9,0	10	0,11	1	-

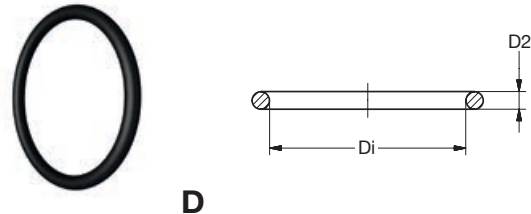

Runddichtring-EPDM für Verschraubungen schwarz
O-Ring gasket-EPDM for unions black

Art Nr Art No	G [Inch]	Di	D2	KG	VE1 PU1
9205 44R1 35	5/8	12,37	2,62	0,001	1
9205 45R1 35	3/4	15,55	2,62	0,001	1
9205 46R1 35	1	20,22	3,53	0,001	1
9201 07R1 35	1 1/4	28,10	3,53	0,002	1
9205 48R1 35	1 1/2	32,92	3,53	0,002	1
9205 50R1 35	2	40,64	5,33	0,003	1
9205 51R1 35	2 1/4	47,00	5,33	0,004	1
9205 54R1 35	2 3/4	59,70	5,33	0,005	1
9205 56R1 35	3 1/2	75,56	5,33	0,01	1
9205 57R1 35	4	91,45	5,33	0,01	1
9205 58R1 35	5	113,66	5,33	0,01	1

Für Wasser, Shorehärte 70
For water, shore hardness 70

Runddichtring-FKM für Verschraubungen schwarz
O-Ring gasket-FKM for unions black

Art Nr Art No	G [Inch]	Di	D2	KG	VE1 PU1
9205 44R3 35	5/8	12,37	2,62	0,001	1
9205 45R3 35	3/4	15,55	2,62	0,001	1
9205 46R3 35	1	20,22	3,53	0,001	1
9201 07R3 35	1 1/4	28,10	3,53	0,002	1
9205 48R3 35	1 1/2	32,92	3,53	0,002	1
9205 50R3 35	2	40,64	5,33	0,003	1
9205 51R3 35	2 1/4	47,00	5,33	0,004	1
9205 54R3 35	2 3/4	59,70	5,33	0,005	1
9205 56R3 35	3 1/2	75,56	5,33	0,01	1
9205 57R3 35	4	91,45	5,33	0,01	1
9205 58R3 35	5	113,66	5,33	0,01	1

Für Wasser, Shorehärte 70
For water, shore hardness 70

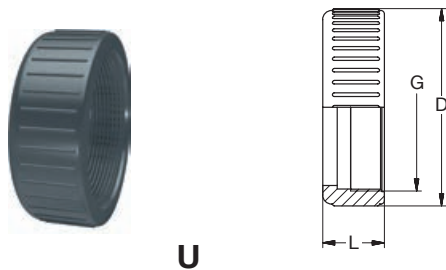

BR PVC-U Verschraubung Überwurfmutter IG-zyl grau
BR PVC-U Union Nut female-thread-cyl grey

Art Nr Art No	d [mm]	DN [mm]	G [Inch]	D	L	PN [bar]	KG	VE1 PU1	VE2 PU2
1350 03U0 32	10	6	5/8	29	19	10	0,010	1	-
1350 03U0 32	12	8	5/8	29	19	10	0,010	1	-
1350 05U0 12	16	10	3/4	33	22	10	0,011	50	1000
1350 06U0 12	20	15	1	41	23	10	0,017	50	750
1350 07U0 12	25	20	1 1/4	51	25	10	0,028	50	400
1350 08U0 12	32	25	1 1/2	58	27	10	0,037	25	300
1350 09U0 12	40	32	2	72	30	10	0,061	1	200
1350 10U0 12	50	40	2 1/4	80	34	10	0,087	1	160
1350 11U0 12	63	50	2 3/4	100	38	10	0,15	1	80
1350 12U0 12	75	65	3 1/2	118	43	10	0,21	1	50
1350 13U0 12	90	80	4	134	45	6	0,29	1	40
1350 14U0 12	110	100	5	159	51	6	0,40	1	25



1.02.05 Verschraubungen • Unions

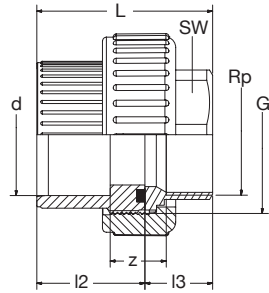

BR PVC-U-GJMW Ü-Verschraubung IG-zyl Runddichtring-EPDM grau

BR PVC-U-GJMW Transition-Union female-thread-cyl O-Ring-gasket-EPDM grey

Art Nr	d x Rp	DN	G	L	l2	l3	z	SW	PN	KG	VE1
Art No	[mm x Inch]	[mm]	[Inch]	[mm]					[bar]		PU1
1T50 0542 32	16 x 3/8	10	3/4	43	17	23	19	22	10	0,080	1
1T50 0643 32	20 x 1/2	15	1	47	19	25	19	25	10	0,12	1
1T50 0745 32	25 x 3/4	20	1 1/4	53	22	28	19	31	10	0,26	1
1T50 0846 32	32 x 1	25	1 1/2	59	25	31	20	38	10	0,30	1
1T50 0947 32	40 x 1 1/4	32	2	65	29	33	20	47	10	0,48	1
1T50 1048 32	50 x 1 1/2	40	2 1/4	73	34	36	23	53	10	0,59	1
1T50 1150 32	63 x 2	50	2 3/4	86	41	42	24	66	10	0,80	1
1T50 1253 32	75 x 2 1/2	65	3 1/2	96	47	46	25	83	10	1,29	1
1T50 1355 32	90 x 3	80	4	111	56	52	30	96	10	1,73	1

Anschluss für Metallgewinde, keine Lagerware, nur komplett lieferbar.

Connection for metal thread, no stock item, only available completely.

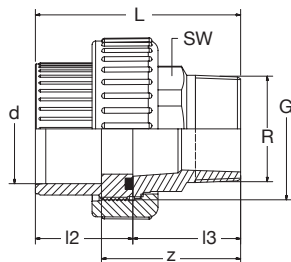

BR PVC-U-GJMW Ü-Verschraubung AG-keg Runddichtring-EPDM grau

BR PVC-U-GJMW Transition-Union male-thread-con O-Ring-gasket-EPDM grey

Art Nr	d x R	DN	G	L	l2	l3	z	SW	PN	KG	VE1
Art No	[mm x Inch]	[mm]	[Inch]	[mm]					[bar]		PU1
1T50 0572 32	16 x 3/8	10	3/4	56	17	39	45	21	10	0,090	1
1T50 0673 32	20 x 1/2	15	1	62	19	43	49	25	10	0,18	1
1T50 0775 32	25 x 3/4	20	1 1/4	71	22	49	55	31	10	0,27	1
1T50 0876 32	32 x 1	25	1 1/2	78	25	53	59	38	10	0,34	1
1T50 0977 32	40 x 1 1/4	32	2	87	29	58	65	47	10	0,59	1
1T50 1078 32	50 x 1 1/2	40	2 1/4	96	34	62	68	53	10	0,72	1
1T50 1180 32	63 x 2	50	2 3/4	112	41	71	76	66	10	1,05	1

Anschluss für Metallgewinde, keine Lagerware, nur komplett lieferbar.

Connection for metal thread, no stock item, only available completely.

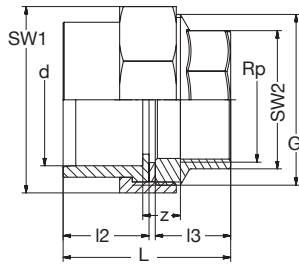

BR PVC-U-V2A Ü-Verschraubung IG-zyl Flachdichtring-EPDM grau

BR PVC-U-Stainless Steel Transition-Union female-thread-cyl flat-gasket-EPDM grey

Art Nr Art No	d x Rp [mm x Inch]	DN [mm]	G [Inch]	L	l2	l3	z	SW1	SW2	PN [bar]	KG	VE1 PU1
1V50 0643 12	20 x 1/2	15	1	47	19	25	18	38	27	10	0,13	1
1V50 0745 12	25 x 3/4	20	1 1/4	53	22	28	19	47	32	10	0,23	1
1V50 0846 12	32 x 1	25	1 1/2	59	25	31	20	52	38	10	0,30	1
1V50 0947 12	40 x 1 1/4	32	2	65	29	33	20	66	47	10	0,48	1
1V50 1048 12	50 x 1 1/2	40	2 1/4	73	34	36	23	72	53	10	0,59	1
1V50 1150 12	63 x 2	50	2 3/4	86	41	42	24	87	65	10	0,97	1
1V50 1253 12	75 x 2 1/2	65	3 1/2	96	47	46	25	110	82	10	1,60	1
1V50 1355 12	90 x 3	80	4	111	56	52	30	120	95	10	2,09	1
1V50 1457 12	110 x 4	100	5	129	66	60	32	150	123	10	3,39	1

Anschluss für Metallgewinde.

Connection for metal thread.

V2A = 1.4305

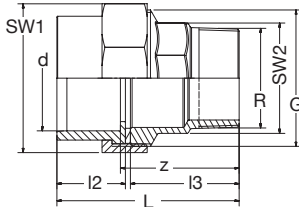

BR PVC-U-V2A Ü-Verschraubung AG-keg Flachdichtring-EPDM grau

BR PVC-U-Stainless Steel Transition-Union male-thread-con flat-gasket-EPDM grey

Art Nr Art No	d x R [mm x Inch]	DN [mm]	G [Inch]	L	l2	l3	z	SW1	SW2	PN [bar]	KG	VE1 PU1
1V50 0673 12	20 x 1/2	15	1	65	19	43	49	38	27	10	0,16	1
1V50 0775 12	25 x 3/4	20	1 1/4	74	22	49	55	47	27	10	0,26	1
1V50 0876 12	32 x 1	25	1 1/2	81	25	53	59	52	34	10	0,36	1
1V50 0977 12	40 x 1 1/4	32	2	90	29	58	64	66	43	10	0,58	1
1V50 1078 12	50 x 1 1/2	40	2 1/4	99	34	62	68	72	50	10	0,72	1
1V50 1180 12	63 x 2	50	2 3/4	115	41	71	77	87	61	10	1,10	1
1V50 1283 12	75 x 2 1/2	65	3 1/2	128	47	78	84	110	80	10	1,91	1
1V50 1385 12	90 x 3	80	4	146	56	87	95	120	80	10	2,43	1
1V50 1487 12	110 x 4	100	5	169	66	100	102	150	123	10	4,26	1

Anschluss für Metallgewinde.

Connection for metal thread.

V2A = 1.4305

Einlegeteil und Runddichtring als Ersatzteil erhältlich. Siehe PVC Kunststoff Verschraubung.
Insert-part and O-Ring as spare parts available. See PVC Union.

1.02.06 Flanschverbindung • Flange connection

Bundbuchse (BB) in verschiedenen Ausführungen für den Einsatz von Flach- und Runddichtungen.

Weitere Informationen zu Flanschen und Dichtungen finden Sie unter Zubehör.

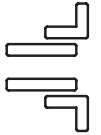

Flange adaptor socket (BB) in various designs for the use of flat and O-ring gaskets.

More information about flanges and gaskets see Accessories.

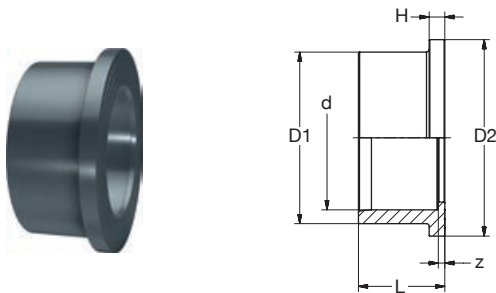

BR PVC-U Bundbuchse gerillt grau
BR PVC-U Flange adaptor socket grooved grey

Art Nr	d	DN	D1	D2	H	L	z	PN	KG	VE1	VE2
Art No	[mm]		[mm]	[mm]	[mm]	[mm]	[mm]	[bar]		PU1	PU2
1330 06F0 12	20	15	27	34	6	19	3	16	0,010	10	200
1330 07F0 12	25	20	33	41	7	22	3	16	0,015	10	100
1330 08F0 12	32	25	41	50	7	25	3	16	0,023	10	100
1330 09F0 12	40	32	50	61	8	29	3	16	0,039	10	100
1330 10F0 12	50	40	61	74	10	35	4	16	0,065	10	60
1330 11F0 12	63	50	76	90	10	41	3	16	0,10	2	20
1330 12F0 12	75	65	90	106	10	47	3	16	0,16	2	14
1330 13F0 12	90	80	108	125	11	56	5	16	0,26	2	18
1330 14F0 12	110	100	131	150	12	66	5	16	0,42	2	8
1330 16F0 12	140	125	165	188	14	81	5	16	0,77	2	6
1330 17F0 12	160	150	188	213	16	91	5	16	1,10	2	8
1330 20F0 12	225	200	248	274	25	125	6	10	1,70	1	6
1330 21F0 32	250	225	274	303	23	131	7	10	2,18	1	-
1330 22F0 32	280	250	306	328	26	146	9	10	2,83	1	-
1330 23F0 32	315	300	342	378	31	164	10	10	4,08	1	-

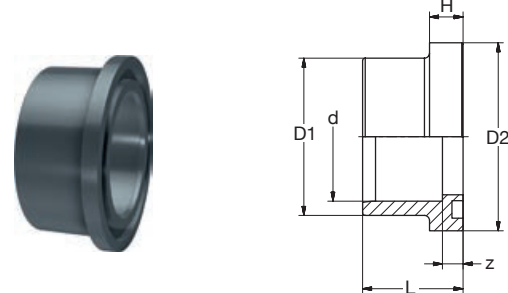

BR PVC-U Bundbuchse O-Ring-Kammer grau
BR PVC-U Flange adaptor socket O-Ring-chamber grey

Art Nr	d	DN	D1	D2	H	L	z	PN	KG	VE1	VE2
Art No	[mm]		[mm]	[mm]	[mm]	[mm]	[mm]	[bar]		PU1	PU2
1330 05R0 12	16	10	22	29	9	20	6	16	0,006	10	250
1330 06R0 12	20	15	27	34	9	22	6	16	0,011	10	200
1330 07R0 12	25	20	33	41	10	25	6	16	0,017	10	100
1330 08R0 12	32	25	41	50	10	28	6	16	0,026	10	100
1330 09R0 12	40	32	50	61	13	34	8	16	0,044	10	100
1330 10R0 12	50	40	61	73	13	39	8	16	0,070	10	60
1330 11R0 12	63	50	76	90	14	46	8	16	0,12	2	20
1330 12R0 12	75	65	90	106	15	52	8	16	0,19	2	12
1330 13R0 12	90	80	108	125	16	61	10	16	0,30	2	18
1330 14R0 12	110	100	131	150	18	72	11	16	0,46	2	8
1330 16R0 12	140	125	165	188	20	87	11	16	0,84	2	6
1330 17R0 12	160	150	188	213	22	97	11	16	1,21	2	8
1330 20R0 12	225	200	248	274	31	131	12	10	1,88	1	6

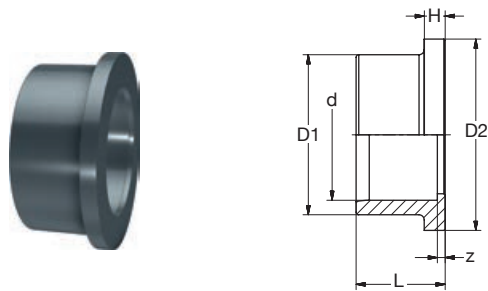

BR PVC-U Bundbuchse glatt grau
BR PVC-U Flange adaptor socket plain grey

Art Nr	d	DN	D1	D2	H	L	z	PN	KG	VE1	VE2
Art No	[mm]		[mm]	[mm]	[mm]	[mm]	[mm]	[bar]		PU1	PU2
1330 0500 12	16	10	22	29	6	17	3	16	0,006	10	250
1330 0600 12	20	15	27	34	6	19	3	16	0,009	10	200
1330 0700 12	25	20	33	41	7	22	3	16	0,014	10	100
1330 0800 12	32	25	41	50	7	25	3	16	0,023	10	100
1330 0900 12	40	32	50	61	8	29	3	16	0,040	10	100
1330 1000 12	50	40	61	74	10	35	4	16	0,062	10	60
1330 1100 12	63	50	76	90	10	41	3	16	0,10	2	20
1330 1200 12	75	65	90	106	10	47	3	16	0,16	2	14
1330 1300 12	90	80	108	125	11	56	5	16	0,26	2	18
1330 1400 12	110	100	131	150	12	66	5	16	0,42	2	8
1330 1600 12	140	125	165	188	14	81	5	16	0,78	2	6
1330 1700 12	160	150	188	213	16	91	5	16	1,14	2	8
1330 2000 12	225	200	248	274	25	125	6	10	1,74	1	6

1.02.06 Flanschverbindung • Flange connection

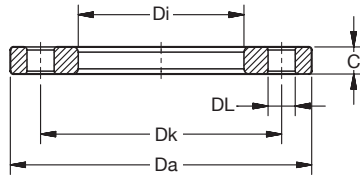

BR PVC-U Losflansch DIN-EN grau

BR PVC-U Flange loose DIN-EN grey

Art Nr Art No	d [mm]	BB	VB	PN [bar] gebohrt drilled	DN	Da	Di	C	nL	DL	DK	KG PU1	VE1 PU1
9131 05E1 32	16	•	•	10/16	10	90	23	12	4	14	60	0,06	5
9131 06E1 32	20	•	•	10/16	15	95	28	12	4	14	65	0,07	5
9131 07E1 32	25	•	•	10/16	20	105	34	14	4	14	75	0,09	5
9131 08E1 12	32	•	•	10/16	25	115	42	15	4	14	85	0,14	5
9131 09E1 12	40	•	•	10/16	32	140	51	15	4	18	100	0,20	5
9131 10E1 12	50	•	•	10/16	40	150	62	16	4	18	110	0,24	5
9131 11E1 12	63	•	•	10/16	50	165	78	18	4	18	125	0,32	5
9131 12E1 12	75	•	•	10/16	65	185	92	19	4	18	145	0,40	5
9132 13E1 12	90	•		10/16	80	200	110	20	8	18	160	0,48	5
9132 14E1 12	110	•		10/16	100	220	133	22	8	18	180	0,60	5
9132 16E1 12	140	•		10/16	125	250	167	26	8	18	210	0,74	5
9132 17E1 12	160	•		10/16	150	285	190	28	8	22	240	1,05	5
9132 20E2 32	225	•		10	200	340	250	30	8	22	295	1,56	5
9132 21E2 32	250	•		10	250	370	277	36	8	22	325	1,80	1
9132 22E2 32	280	•		10	250	399	307	32	12	22	350	1,84	1
9132 23E2 32	315	•		10	300	450	345	34	12	22	400	2,45	1

BB = Bundbuchse • Flange adaptor socket

VB = Vorschweißbund • Flange adaptor spigot

Zubehör Flanschverbindung B-Buchse PVC-U
Accessories Flange Connection socket PVC-U



Losflansch
Flange loose



Blindflansch
Flange blind

d [mm]	DN [mm]	PVC-U		PP-St		PP-GGG	PP-St	PP-St			
		DIN/EN				ANSI			DIN/EN		ANSI
		PN10/16	PN10	PN10/16	PN10	150 lbs			PN10/16	PN10	150 lbs
16	10	9131 05E1 32									
20	15	9131 06E1 32		9141 06E1 35			9141 06A2 38	9144 06A2 38			
25	20	9131 07E1 32		9141 07E1 15			9141 07A2 38	9144 07E1 35		9144 07A2 38	
32	25	9131 08E1 12		9141 08E1 15			0141 08A2 38	9144 08E1 35		9144 08A2 38	
40	32	9131 09E1 12		9141 09E1 15			9141 09A2 38	9144 09E1 35		9144 09A2 38	
50	40	9131 10E1 12		9141 10E1 15			9141 10A2 38	9144 10E1 35		9144 10A2 38	
63	50	9131 11E1 12		9141 11E1 15		9151 11A2 25		9144 11E1 35		9144 11A2 38	
75	65	9131 12E1 12		9141 12E1 15			9141 12A2 38	9144 12E1 35		9144 12A2 38	
90	80	9131 13E1 12		9142 13E1 15			9141 13A2 38	9144 13E1 35		9144 13A2 38	
110	100	9131 14E1 12		9142 14E1 15		9152 14A2 25		9144 14E1 35		9144 14A2 38	
140	125	9131 16E1 12		9142 16E1 15				9144 16E1 35			
160	150	9131 17E1 12		9142 17E1 15				9144 17E1 35		9144 17A2 38	
225	200	9132 20E2 32		9142 20E2 15				9144 19E2 35			
250	225	9132 21E2 32						9144 21E2 35		9144 21A2 38	
280	250	9132 22E2 32						9144 21E2 35			
315	300	9132 23E2 32						9144 23E2 35		9144 23A2 38	

Flachdichtringe für BB gerillt und flach
Flat-Gasket for flange adaptor grooved and plain



mit Stahl-Einlage
with Steel-inlay

Runddichtringe für BB mit O-Ring-Kammer
O-Ring-Gasket for flange adaptor with O-Ring chamber



d [mm]	DN [mm]	EPDM		EPDM-St	NBR-St	EPDM		FKM (FPM)
		Wasser/Water		Wasser/Water	Gas/Gas	Wasser/Water		
		PN10		PN10		PN10		
16	10	9201 05F1 35		9202 05F1 35	9202 05F2 35	9201 05R1 35		9201 05R3 35
20	15	9201 06F1 35		9202 06F1 35	9202 06F2 35	9201 06R1 35		9201 06R3 35
25	20	9201 07F1 35		9202 07F1 35	9202 07F2 35	9201 07R1 35		9201 07R3 35
32	25	9201 08F1 35		9202 08F1 35	9202 08F2 35	9201 08R1 35		9201 08R3 35
40	32	9201 09F1 35		9202 09F1 35	9202 09F2 35	9201 09R1 35		9201 09R3 35
50	40	9201 10F1 35		9202 10F1 35	9202 10F2 35	9201 10R1 35		9201 10R3 35
63	50	9201 11F1 35		9202 11F1 35	9202 11F2 35	9201 11R1 35		9201 11R3 35
75	65	9201 12F1 35		9202 12F1 35	9202 12F2 35	9201 12R1 35		9201 12R3 35
90	80	9201 13F1 35		9202 13F1 35	9202 13F2 35	9201 13R1 35		9201 13R3 35
110	100	9201 14F1 35		9202 14F1 35	9202 14F2 35	9201 14R1 35		9201 14R3 35
140	125	9201 16F1 35		9202 16F1 35	9202 16F2 35	9201 16R1 35		9201 16R3 35
160	150	9201 17F1 35		9202 17F1 35	9202 17F2 35	9201 17R1 35		9201 17R3 35
225	200	9201 20F1 35		9202 20F1 35	9202 20F2 35	9201 20R1 35		9201 20R3 35
250	225			9202 21F1 35	9202 21F2 35			
280	250			9202 22F1 35	9202 22F2 35			
315	300			9202 23F1 35	9202 23F2 35			

* Nicht für PVC-U Flansche!
* Not for PVC-U flanges!



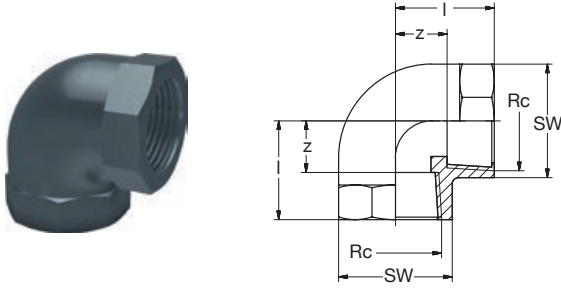

BR PVC-U Winkel 90° IG-keg grau
BR PVC-U Elbow 90° female-thread-con grey

Art Nr Art No	Rc [Inch]	l [mm]	z [mm]	SW [mm]	PN [bar]	KG	VE1 PU1	VE2 PU2
1620 43C0 12	1/2	28	14	30	10	0,030	10	120
1620 45C0 12	3/4	33	17	36	10	0,048	10	80
1620 46C0 12	1	40	22	46	10	0,10	10	80
1620 47C0 12	1 1/4	49	28	55	10	0,15	10	90
1620 48C0 12	1 1/2	59	38	65	1,0	0,27	10	30

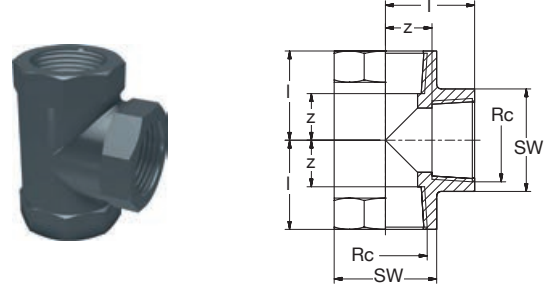

BR PVC-U T-Stück 90° IG-keg grau
BR PVC-U Tee 90° female-thread-con grey

Art Nr Art No	Rc [Inch]	l [mm]	z [mm]	SW [mm]	PN [bar]	KG	VE1 PU1	VE2 PU2
1640 43C0 12	1/2	28	14	30	10	0,040	10	80
1640 45C0 12	3/4	33	17	36	10	0,062	10	50
1640 46C0 12	1	40	22	46	10	0,13	10	60
1640 47C0 12	1 1/4	49	28	55	10	0,20	10	30
1640 48C0 12	1 1/2	59	38	65	10	0,35	10	20

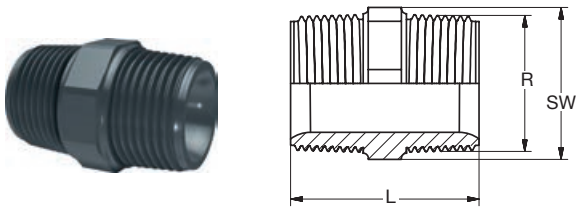

BR PVC-U Doppelnippel AG-keg grau
BR PVC-U Hexagon nipple male-thread-con grey

Art Nr Art No	R [Inch]	DN [mm]	L [mm]	SW [mm]	PN [bar]	KG	VE1 PU1	VE2 PU2
1610 7200 12	3/8	10	34	22	10	0,010	10	200
1610 7300 12	1/2	15	43	24	10	0,014	10	200
1610 7500 12	3/4	20	47	30	10	0,022	10	120
1610 7600 12	1	25	53	36	10	0,033	10	80
1610 7700 12	1 1/4	32	57	46	10	0,049	10	120
1610 7800 12	1 1/2	40	57	55	10	0,067	10	60
1610 8000 12	2	50	68	65	10	0,11	10	90

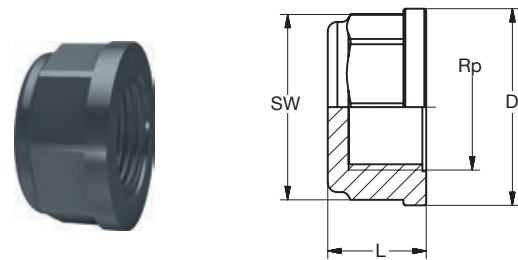

BR PVC-U Kappe IG-zyl grau
BR PVC-U Cap female-thread-cyl grey

Art Nr Art No	Rp [Inch]	D [mm]	L [mm]	SW [mm]	PN [bar]	KG	VE1 PU1	VE2 PU2
1690 4000 12	1/8	20	14	17	10	0,004	10	1000
1690 4100 12	1/4	26	16	22	10	0,007	10	400
1690 4200 12	3/8	31	19	27	10	0,011	10	200
1690 4300 12	1/2	37	21	32	10	0,018	10	200
1690 4500 12	3/4	43	24	36	10	0,023	10	160
1690 4600 12	1	52	26	46	10	0,039	10	100
1690 4700 12	1 1/4	62	29	55	10	0,055	10	110
1690 4800 12	1 1/2	66	31	60	10	0,069	10	100
1690 5000 12	2	82	36	75	10	0,12	5	75

1.02.07 Formteile mit Kunststoff-Gewinde • Fittings with plastic-thread

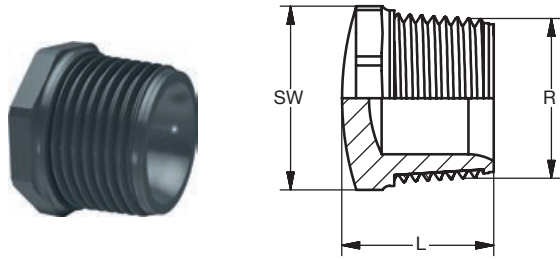

BR PVC-U Stopfen AG-keg grau
BR PVC-U Plug male-thread-con grey

Art Nr	R	L	SW	PN	KG	VE1	VE2
Art No	[Inch]	[mm]	[bar]			PU1	PU2
1670 7200 12	3/8	21	22	10	0,010	10	200
1670 7300 12	1/2	27	24	10	0,011	10	150
1670 7500 12	3/4	29	30	10	0,016	10	150
1670 7600 12	1	32	36	10	0,027	10	120
1670 7700 12	1 1/4	36	46	10	0,041	10	80
1670 7800 12	1 1/2	37	55	10	0,062	10	100
1670 8000 12	2	42	65	10	0,096	5	60

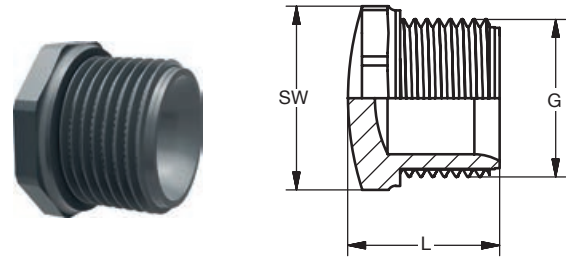

BR PVC-U Stopfen AG-zyl grau
BR PVC-U Plug male-thread-cyl grey

Art Nr	G	L	SW	PN	KG	VE1	VE2
Art No	[Inch]	[mm]	[bar]			PU1	PU2
1670 72G0 32	3/8	21	22	10	0,010	10	200
1670 73G0 12	1/2	27	24	10	0,016	10	150
1670 75G0 32	3/4	29	30	10	0,010	10	150
1670 76G0 32	1	32	36	10	0,020	10	120
1670 77G0 32	1 1/4	36	46	10	0,050	10	80
1670 78G0 32	1 1/2	37	55	10	0,060	10	100
1670 80G0 32	2	42	65	10	0,10	5	60
1670 83G0 32	2 1/2	59	80	10	0,18	1	-
1670 85G0 32	3	76	93	10	0,26	1	-
1670 87G0 12	4	84	131	10	0,64	1	-

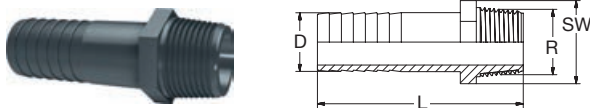

BR PVC-U Druckschlauchtülle AG-keg grau
BR PVC-U Hose nozzle male-thread-con grey

Art Nr	R	DN	D	L	SW	PN	KG	VE1	VE2
Art No	[Inch]		[mm]			[bar]		PU1	PU2
1680 7100 32	1/4	8	12	51	14	10	0,010	10	-
1680 7200 32	3/8	10	16	57	19	10	0,010	10	-
1680 7300 32	1/2	15	20	73	22	10	0,020	10	-
1680 7500 32	3/4	20	25	79	27	10	0,030	10	-
1680 7600 32	1	25	30	89	36	10	0,040	10	-
1680 7700 32	1 1/4	32	40	100	46	10	0,080	10	-
1680 7800 32	1 1/2	40	50	114	52	10	0,11	10	-
1680 8000 32	2	50	60	132	65	10	0,13	10	-

1.02.08 Kugelhähne • Ball valves

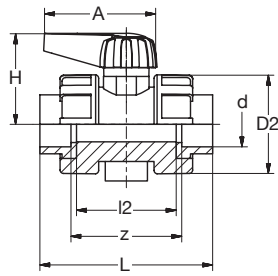

BR PVC-U Kugelhahn verschraubt Runddichtung-EPDM/FKM grau
BR PVC-U Ball valve with Union-nuts O-Ring-gasket-EPDM/FKM grey

Art Nr Art No	d [mm]	DN	D2	L	l2	A	H	z	PN [bar]	KG	VE1 PU1
EPDM											
1910 06R1 22	20	15	50	95	56	66	48	63	16	0,14	1
1910 07R1 22	25	20	59	110	65	82	57	72	16	0,23	1
1910 08R1 22	32	25	71	122	71	82	65	78	16	0,32	1
1910 09R1 22	40	32	86	143	86	92	84	91	16	0,53	1
1910 10R1 22	50	40	100	158	90	92	90	96	16	0,69	1
1910 11R1 22	63	50	126	183	101	143	115	107	16	1,22	1
FKM (FPM)											
1910 06R3 22	20	15	50	95	56	66	48	63	16	0,14	1
1910 07R3 22	25	20	59	110	65	82	57	72	16	0,23	1
1910 08R3 22	32	25	71	122	71	82	65	78	16	0,32	1
1910 09R3 22	40	32	86	143	86	92	84	91	16	0,53	1
1910 10R3 22	50	40	100	158	90	92	90	96	16	0,69	1
1910 11R3 22	63	50	126	183	101	143	115	107	16	1,22	1

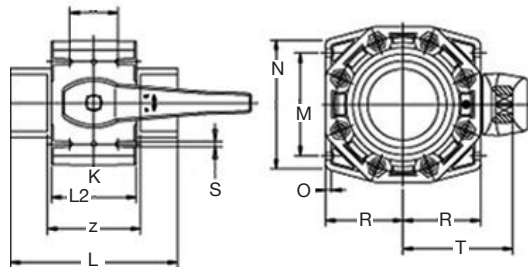

BR PVC-U Kugelhahn Muffenflansch Dichtung-EPDM/FKM grau
BR PVC-U Ball valve socket-flange gasket-EPDM/FKM grey

Art Nr Art No	d [mm]	DN	K	L	L2	M	N	O	R	S	T	z	PN [bar]	KG	VE1 PU1
EPDM															
191M 12R1 32	75	65	60	206	112	110	130	5,5	84,0	8,5	127	118	10	6,66	1
191M 13R1 32	90	80	60	236	124	124	140	6,0	92,5	8,5	135	134	10	7,80	1
191M 14R1 32	110	100	80	276	144	136	160	8,0	102,5	8,5	148	154	10	9,97	1
FKM (FPM)															
191M 12R3 32	75	65	60	206	112	110	130	5,5	84,0	8,5	127	118	10	6,66	1
191M 13R3 32	90	80	60	236	124	124	140	6,0	92,5	8,5	135	134	10	7,80	1
191M 14R3 32	110	100	80	276	144	136	160	8,0	102,5	8,5	148	154	10	9,97	1

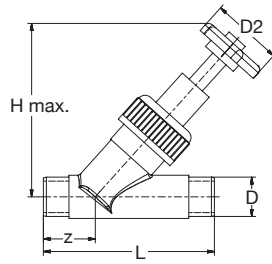

BR PVC-U Ventil Schrägsitz Runddichtring-EPDM grau
BR PVC-U Valve angle seat O-Ring-gasket-EPDM grey

Art Nr	D	DN	D2	L	H	z	PN	KG	VE1	VE2
Art No	[mm]		[mm]				[bar]		PU1	PU2
1930 0500 32	16	10	50	114	105	24	10	0,12	A	-
1930 0600 32	20	15	63	124	135	33	10	0,23	1	-
1930 0700 32	25	20	63	144	135	33	10	0,25	1	-
1930 0800 32	32	25	63	154	143	37	10	0,35	1	-
1930 0900 32	40	32	80	174	182	48	10	0,62	1	-
1930 1000 32	50	40	80	194	204	48	10	1,09	1	-
1930 1100 32	63	50	100	224	276	60	10	1,52	1	-

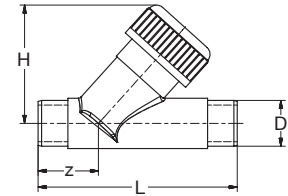

BR PVC-U Ventil Schrägsitz Rückschlag Runddichtring-EPDM grau
BR PVC-U Valve angle seat non-return O-Ring-gasket-EPDM grey

Art Nr	D	DN	L	H	z	PN	KG	VE1	VE2
Art No	[mm]		[mm]			[bar]		PU1	PU2
1930 06R0 32	20	15	124	65	33	10	0,19	1	-
1930 07R0 32	25	20	144	75	33	10	0,21	1	-
1930 08R0 32	32	25	154	90	37	10	0,32	1	-
1930 09R0 32	40	32	174	102	48	10	0,51	1	-
1930 10R0 32	50	40	194	123	48	10	0,84	1	-
1930 11R0 32	63	50	224	144	60	10	1,40	1	-

Horizontal und vertikal einsetzbar.
Horizontal and vertical use.

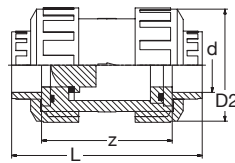

BR PVC-U Ventil Rückschlag Runddichtring-EPDM grau
BR PVC-U Valve non-return O-Ring-gasket-EPDM grey

Art Nr	d	DN	D2	L	z	PN	KG	VE1	VE2
Art No	[mm]		[mm]			[bar]		PU1	PU2
1940 05R0 32	16	10	50	81	53	16	0,10	1	50
1940 06R0 32	20	15	50	81	49	16	0,11	1	50
1940 07R0 32	25	20	60	94	56	16	0,17	1	32
1940 08R0 32	32	25	68	107	63	16	0,25	1	22
1940 09R0 32	40	32	80	124	72	16	0,40	1	27
1940 10R0 32	50	40	96	146	84	16	0,66	1	18
1940 11R0 32	63	50	116	170	94	16	1,12	1	10
1940 12R0 32	75	65	145	218	130	10	1,74	1	5
1940 13R0 32	90	80	166	250	148	10	2,77	1	3
1940 14R0 32	110	100	210	290	168	10	4,74	1	2

Federbelastet, Edelstahlfeder PTFE-ummantelt.
Spring-loaded, Stainless steel spring PTFE-coated.

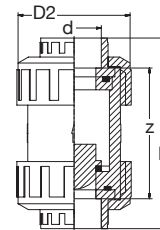

BR PVC-U Ventil Fuß Runddichtring-EPDM grau
BR PVC-U Valve foot O-Ring-gasket-EPDM grey

Art Nr	d	DN	D2	L	z	PN	KG	VE1	VE2
Art No	[mm]		[mm]			[bar]		PU1	PU2
1940 05F0 32	16	10	50	81	53	16	0,095	1	50
1940 06F0 32	20	15	50	81	49	16	0,12	1	50
1940 07F0 32	25	20	60	94	56	16	0,22	1	32
1940 08F0 32	32	25	68	107	63	16	0,27	1	22
1940 09F0 32	40	32	80	124	72	16	0,49	1	27
1940 10F0 32	50	40	96	146	84	16	0,75	1	18
1940 11F0 32	63	50	116	170	94	16	1,35	1	10
1940 12F0 32	75	65	145	218	130	10	1,89	1	2
1940 13F0 32	90	80	166	250	148	10	3,31	1	2
1940 14F0 32	110	100	210	290	168	10	5,08	1	2

Unsere Polyethylen gespritzten Formteile zeichnen sich durch hervorragende physikalische und mechanische Merkmale aus. Dadurch ergeben sich vielfältige Einsatzmöglichkeiten.

Durch die feine Oberflächenstruktur sind PE-Formteile ein idealer Werkstoff für die Beförderung von Gasen und Flüssigkeiten.

Die hervorragende UV-Beständigkeit bietet die Möglichkeit zur Außeninstallation ohne Aufwand für zusätzliche Schutzmaßnahmen. Unsere Formteile bewähren sich seit Jahrzehnten in der Gas- und Wasserversorgung.

Eigenschaften

- Geringes Eigengewicht
- UV-Beständigkeit
- Hohe chemische Beständigkeit
- Hohe Schlagzähigkeit bei tiefen Temperaturen
- Korrosionsbeständigkeit
- Licht- und Witterungsbeständigkeit
- Hohe Abriebfestigkeit
- Hervorragende Verarbeitungseigenschaften

Werkstoff

Polyethylen (PE100) klassifiziert nach der Mindestlangzeitfestigkeit (MRS), Farbe Schwarz.

Verbindungstechnik

- Heizelement-Stumpf-Schweißung
- Heizwendel-Muffen-Schweißung
- Flanschverbindung

Our injection moulded Polyethylene fittings are characterised by excellent physical and mechanical properties. This results in multiple applications.

Through the fine surface structure, injection moulded PE fittings are ideal for transporting gases and liquids.

The excellent UV resistance offers the possibility for outside installation without further need for additional protection effort. Our injection moulded fittings have been approved and applied for decades in gas and water supply.

Properties

- Low dead weight
- UV resistance
- High resistance to chemicals
- High impact strength at low temperatures
- Corrosion resistance
- Light resistance and weather resistant
- High abrasion resistance
- Excellent processing properties

Material

Polyethylene (PE100) classified according to minimum long-term strength (MRS), colour black.

Joining technology

- Butt-welding
- Electrofusion socket-welding
- Flange connection



2.01 Rohre mehrlagig • Pipes multi-layer PE 3



2.02 Formteile lang • Fittings long PE 4

2.02.01 Winkel lang Elbows long PE 4



2.02.02 T-Stücke, Abzweige lang Tee's, Branches long PE 6



2.02.03 Reduktionen, Kappen lang Reducers, Caps long PE 9

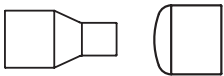

2.02.04 Übergänge lang Transitions long PE 12

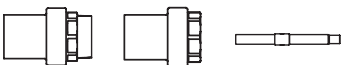

2.02.05 Verschraubungen lang Unions long PE 13

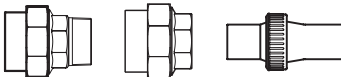

2.02.06 Flanschverbindung lang Flange connection long PE 15



2.02.07 Kugelhähne lang Ball Valves long PE 20

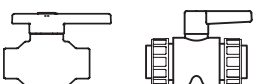

2.03 Formteile kurz • Fittings short PE 21

2.03.01 Bögen, Winkel kurz Bends, Elbows short PE 21

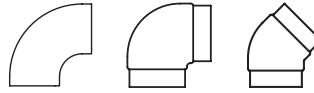

2.03.02 T-Stücke kurz Tee's short PE 23

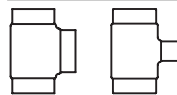

2.03.03 Reduktionen kurz Reducers short PE 24



2.03.04 Übergänge kurz Transitions short PE 26



2.03.05 Flanschverbindung kurz Flange connection short PE 27

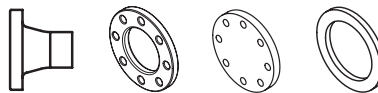

2.04 E-Formteile • E-Fittings PE 29



2.05 Rohrbögen nahtlos • Pipe bends seamless PE 32



2.01 Rohre mehrlagig · Pipes multi-layer

BLACKTECplus

Beschreibung

PE100 Druckrohr BLACKTECplus, schwarz, mehrlagig, mit Faser-Mittelschicht zur Reduzierung der axialen Ausdehnung, SDR11 und 17.

Faser-Rohre können, analog zu normalen Rohren, ohne vorherigen Bearbeitungsschritt direkt verschweißt werden.

Werkstoff

PE100 (Polyethylen), schwarz. Das Material entspricht den Anforderungen der aktuellen KTW-Leitlinie des Umweltbundesamtes (UBA).

Geometrische Eigenschaften

Abmessungen und Toleranzen entsprechend EN 1555-2 und EN 12201-2, sowie ISO 4427-2 und ISO 4437-2.

Betriebsdruck

SDR11 = PN16 (20°C/1,6 MPa)

SDR17 = PN10 (20°C/1,0 MPa)

Ausführung

Geeignet für Heizelement-Stumpf-Schweißung und Heizwendel-Muffen-Schweißung nach DVS Richtlinie 2207. Schweiß-Geräte und Schweiß-Werkzeuge entsprechend DVS Richtlinie 2208.

Zertifizierung

In Vorbereitung.

Lieferung

In 5 m Stangen; lose gepackt und an den Rohrenden geschlossen. Andere Längen auf Anfrage. Abgabe erfolgt nur in kompletten Rohrlängen und Verpackungseinheiten (VEs).

BLACKTECplus

Description

PE100 Pressure pipe BLACKTECplus, black, multi-layer, with fiber-middle-layer for reduced axial expansion, SDR11 and 17.

Fiber-layer-pipes can be, analogue to normal pipes, directly welded without a prior processing step.

Material

PE100 (Polyethylene), black. The material complies with the requirements of the KTW guideline of the German Federal Environmental Agency (UBA).

Geometric Properties

Dimensions and tolerances according to EN 1555-2 and EN 12201-2, plus ISO 4427-2 and ISO 4437-2.

Operating Pressure

SDR11 = PN16 (20°C/1.6 MPa)

SDR17 = PN10 (20°C/1.0 MPa)

Type

Suitable for butt-welding and electrofusion-socket-welding according to DVS technical code 2207. Welding equipment according to DVS technical code 2208.

Certification

Under preparation.

Delivery

in 5 m rods; loosely packed and closed at the pipe ends. Other length's on request. Supply only in complete length's and packing units (PU's).

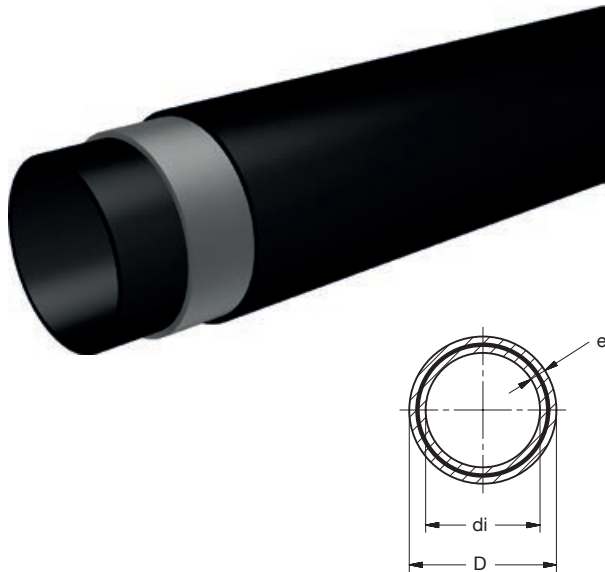

BR PE100 Druckrohr BLACKTECplus **SDR11** 1,6MPa schwarz 5m

BR PE100 Pressure pipe BLACKTECplus **SDR11** 1.6MPa schwarz 5m

Art Nr	D	e	DN	di	SDR	L	KG	VE1	VE2
Art No	[mm]			[mm]		[m]		PU1	PU2
2F14 1150 15	63	5,8	50	51,4	11	5	1,11	25	500
2F14 1250 15	75	6,8	-	61,4	11	5	1,53	10	320
2F14 1350 15	90	8,2	65	73,6	11	5	2,19	10	220
2F14 1450 15	110	10,0	80	90,0	11	5	3,20	10	150
2F14 1550 15	125	11,4	100	102,2	11	5	4,20	5	125
2F14 1650 15	140	12,7	-	114,6	11	5	5,20	5	95
2F14 1750 15	160	14,6	125	130,8	11	5	6,80	5	60
2F14 1850 15	180	16,4	-	147,2	11	5	8,70	5	60
2F14 1950 15	200	18,2	160	163,6	11	5	10,70	5	45
2F14 2050 15	225	20,5	-	184,0	11	5	13,50	5	30

BR PE100 Druckrohr BLACKTECplus **SDR17** 1,0MPa schwarz 5m

BR PE100 Pressure pipe BLACKTECplus **SDR17** 1.0MPa schwarz 5m

Art Nr	D	e	DN	di	SDR	L	KG	VE1	VE2
Art No	[mm]			[mm]		[m]		PU1	PU2
2F15 1750 15	160	9,5	-	141,0	17	5	4,70	5	60
2F15 1850 15	180	10,7	150	158,6	17	5	5,90	5	60
2F15 1950 15	200	11,9	180	176,2	17	5	7,32	5	45
2F15 2050 15	225	13,4	200	198,2	17	5	9,50	5	30

2.02 Formteile lang • Fittings LONG

PE100 Formteile mit langen Schweißenden SDR11/17 schwarz

gespritzt, für die Heizelement-Stumpf-Schweißung und Heizwendel-Muffen-Schweißung

Werkstoff

PE100, schwarz. Das Material entspricht den Anforderungen der aktuellen KTW-Leitlinie des Umweltbundesamtes (UBA).

Geometrische Eigenschaften

Abmessungen und Toleranzen der Schweißenden entsprechend EN 1555-3 und EN 12201-3, sowie ISO 4427-3 und ISO 4437-3.

Toleranzen bei den Z-Maßangaben sind abhängig von der Dimension. Bis d/D 160 = +/- 3 mm. Ab d/D 180 = +/- 10 mm.

Ausführung

Geeignet für Heizelement-Stumpf-Schweißung und Heizwendel-Muffen-Schweißung nach DVS Richtlinie 2207. Schweiß-Geräte und Schweiß-Werkzeuge sollten der DVS Richtlinie 2208 entsprechen.

Lieferung

Abgabe erfolgt nur in kompletten Verpackungseinheiten (VE's).

PE100 Fittings with long spigots SDR11/17 black

injection moulded, for butt-welding and electrofusion socket-welding

Material

PE100, black. The material complies with the requirements of the KTW guideline of the German Federal Environmental Agency (UBA).

Geometric Properties

Dimensions and tolerances of the spigot ends thickness according to EN 1555-3 and EN 12201-3, plus ISO 4427-3 and ISO 4437-3.

Tolerances of z-sizes depend on the dimension. Up to d/D 160 = +/- 3 mm and from d/D 180 = +/- 10 mm.

Type

Suitable for butt-welding and electrofusion socket-welding according to DVS technical code 2207. Welding equipment according to DVS technical code 2208.

Delivery

Supply only in complete packing units (PU's).

2.02.01 Winkel lang • Elbows long

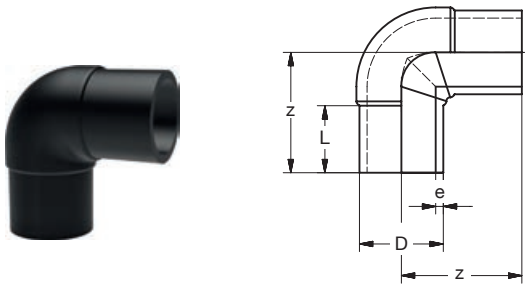

BR PE100 Winkel 90° lang **SDR11** schwarz

BR PE100 Elbow 90° long **SDR11** black

Art Nr	D	e	L	z	KG	VE1	VE2
Art No	[mm]		[mm]			PU1	PU2
2413 0790 15	25	2,3	42	63	0,023	5	100
2413 0890 15	32	3,0	47	72	0,043	5	60
2413 0990 15	40	3,7	44	69	0,069	5	100
2413 1090 15	50	4,6	61	95	0,12	5	50
2413 1190 15	63	5,8	67	115	0,27	5	35
2413 1290 15	75	6,8	78	128	0,42	1	20
2413 1390 15	90	8,2	78	141	0,62	1	10
2413 1490 15	110	10,0	85	157	1,05	1	10
2413 1590 15	125	11,4	100	170	1,67	1	6
2413 1690 15	140	12,7	105	198	2,21	1	3
2413 1790 15	160	14,6	117	220	3,08	1	-
2413 1890 15	180	16,4	114	221	4,12	1	-
2413 1990 15	200	18,2	126	249	5,75	1	-
2413 2090 15	225	20,5	135	269	7,94	1	-
2413 2190 15	250	22,7	148	307	10,2	1	-
2413 2290 15	280	25,4	156	332	13,6	1	-
2413 2390 15	315	28,6	170	359	18,8	1	-
2413 2490 15	355	32,2	170	410	30,2	1	-
2413 2590 15	400	36,6	187	469	41,7	1	-
2413 2690 15	450	40,9	202	522	58,9	1	-
2413 2790 15	500	45,4	222	562	79,5	1	-

BR PE100 Winkel 90° lang **SDR17** schwarz

BR PE100 Elbow 90° long **SDR17** black

Art Nr	D	e	L	z	KG	VE1	VE2
Art No	[mm]		[mm]			PU1	PU2
2414 1190 15	63	3,8	67	115	0,23	5	35
2414 1290 15	75	4,5	78	128	0,36	1	20
2414 1390 15	90	5,4	78	141	0,52	1	10
2414 1490 15	110	6,6	85	157	0,89	1	10
2414 1590 15	125	7,4	100	170	1,42	1	6
2414 1690 15	140	8,3	105	198	1,71	1	3
2414 1790 15	160	9,5	117	220	2,33	1	-
2414 1890 15	180	10,7	114	221	3,13	1	-
2414 1990 15	200	11,9	126	249	4,34	1	-
2414 2090 15	225	13,4	135	269	5,80	1	-
2414 2190 15	250	14,8	148	307	7,62	1	-
2414 2290 15	280	16,6	156	332	10,2	1	-
2414 2390 15	315	18,7	170	359	13,9	1	-
2414 2490 15	355	21,1	170	410	22,7	1	-
2414 2590 15	400	23,7	187	469	30,7	1	-
2414 2690 15	450	26,7	202	522	43,4	1	-
2414 2790 15	500	29,7	222	562	60,1	1	-

2.02.01 Winkel lang • Elbows long

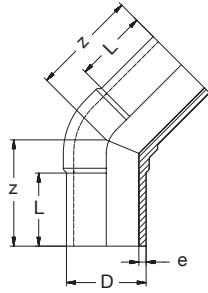

BR PE100 Winkel 45° lang **SDR11** schwarz

BR PE100 Elbow 45° long **SDR11** black

Art Nr Art No	D [mm]	e [mm]	L [mm]	z	KG	VE1 PU1	VE2 PU2
2413 0745 15	25	2,3	35	41	0,020	5	150
2413 0845 15	32	3,0	40	48	0,034	5	80
2413 0945 15	40	3,7	44	58	0,076	5	50
2413 1045 15	50	4,6	54	74	0,12	5	90
2413 1145 15	63	5,8	70	82	0,23	5	30
2413 1245 15	75	6,8	76	98	0,31	2	20
2413 1345 15	90	8,2	84	120	0,58	1	12
2413 1445 15	110	10,0	89	130	0,92	1	8
2413 1545 15	125	11,4	100	145	1,25	1	6
2413 1645 15	140	12,7	104	154	1,72	1	3
2413 1745 15	160	14,6	111	168	2,60	1	-
2413 1845 15	180	16,4	118	185	3,56	1	-
2413 1945 15	200	18,2	127	202	4,68	1	-
2413 2045 15	225	20,5	135	216	5,52	1	-
2413 2145 15	250	22,7	141	233	8,92	1	-
2413 2245 15	280	25,4	145	242	11,4	1	-
2413 2345 15	315	28,6	165	265	15,4	1	-
2413 2445 15	355	32,2	170	317	23,5	1	-
2413 2545 15	400	36,6	187	346	30,0	1	-
2413 2645 15	450	40,9	202	375	44,0	1	-
2413 2745 15	500	45,4	222	410	57,0	1	-

BR PE100 Winkel 45° lang **SDR17** schwarz

BR PE100 Elbow 45° long **SDR17** black

Art Nr Art No	D [mm]	e [mm]	L [mm]	z	KG	VE1 PU1	VE2 PU2
2414 1145 15	63	3,8	70	82	0,25	5	30
2414 1245 15	75	4,5	76	98	0,28	2	20
2414 1345 15	90	5,4	84	120	0,47	1	12
2414 1445 15	110	6,6	89	130	0,73	1	8
2414 1545 15	125	7,4	100	145	1,03	1	6
2414 1645 15	140	8,3	104	154	1,33	1	3
2414 1745 15	160	9,5	111	168	1,97	1	-
2414 1845 15	180	10,7	118	185	2,67	1	-
2414 1945 15	200	11,9	127	202	3,62	1	-
2414 2045 15	225	13,4	135	216	4,75	1	-
2414 2145 15	250	14,8	141	233	6,12	1	-
2414 2245 15	280	16,6	145	242	8,33	1	-
2414 2345 15	315	18,7	165	265	11,5	1	-
2414 2445 15	355	21,1	170	317	17,3	1	-
2414 2545 15	400	23,7	187	346	23,0	1	-
2414 2645 15	450	26,7	202	375	33,0	1	-
2414 2745 15	500	29,7	222	410	42,8	1	-

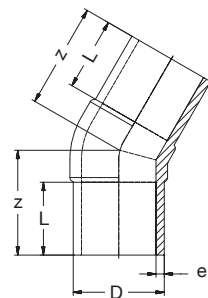

BR PE100 Winkel 30° lang **SDR11** schwarz

BR PE100 Elbow 30° long **SDR11** black

Art Nr Art No	D [mm]	e [mm]	L [mm]	z	KG	VE1 PU1	VE2 PU2
2413 1230 15	75	6,8	77	103	0,34	2	20
2413 1330 15	90	8,2	85	110	0,55	2	14
2413 1430 15	110	10,0	95	130	0,93	2	8
2413 1530 15	125	11,4	100	142	1,25	1	4
2413 1630 15	140	12,7	103	144	1,60	1	3
2413 1730 15	160	14,6	116	155	2,38	1	3
2413 1830 15	180	16,4	120	165	3,01	1	-
2413 1930 15	200	18,2	125	175	4,01	1	-
2413 2030 15	225	20,5	133	188	5,50	1	-

BR PE100 Winkel 30° lang **SDR17** schwarz

BR PE100 Elbow 30° long **SDR17** black

Art Nr Art No	D [mm]	e [mm]	L [mm]	z	KG	VE1 PU1	VE2 PU2
2414 1230 15	75	4,5	77	103	0,30	1	20
2414 1330 15	90	5,4	85	110	0,46	1	14
2414 1430 15	110	6,6	95	130	0,70	1	8
2414 1530 15	125	7,4	100	142	1,02	1	4
2414 1630 15	140	8,3	103	144	1,28	1	4
2414 1730 15	160	9,5	116	155	1,89	1	3
2414 1830 15	180	10,7	120	165	2,30	1	-
2414 1930 15	200	11,9	125	175	3,06	1	-
2414 2030 15	225	13,4	133	188	4,19	1	-



2.02.02 T-Stücke, Abzweige lang • Tee's, Branches long

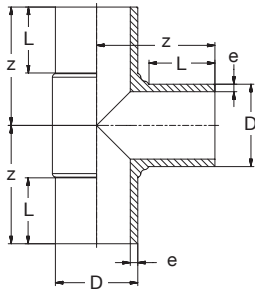

BR PE100 T-Stück 90° lang **SDR11** schwarz
BR PE100 Tee 90° long **SDR11** black

Art Nr Art No	D [mm]	e	L	z	KG	VE1 PU1	VE2 PU2
2513 0790 15	25	2,3	41	62	0,034	5	150
2513 0890 15	32	3,0	51	75	0,065	5	80
2513 0990 15	40	3,7	55	82	0,12	5	60
2513 1090 15	50	4,6	61	95	0,18	5	40
2513 1190 15	63	5,8	67	114	0,39	5	20
2513 1290 15	75	6,8	73	121	0,55	1	10
2513 1390 15	90	8,2	82	153	1,00	1	8
2513 1490 15	110	10,0	98	172	1,62	1	6
2513 1590 15	125	11,4	102	180	2,05	1	3
2513 1690 15	140	12,7	105	195	2,90	1	2
2513 1790 15	160	14,6	124	225	4,30	1	-
2513 1890 15	180	16,4	117	233	5,69	1	-
2513 1990 15	200	18,2	127	253	7,72	1	-
2513 2090 15	225	20,5	136	275	10,7	1	-
2513 2190 15	250	22,7	140	298	13,0	1	-
2513 2290 15	280	25,4	150	325	18,9	1	-
2513 2390 15	315	28,6	160	350	27,0	1	-
2513 2490 15	355	32,2	173	390	36,4	1	-
2513 2590 15	400	36,3	187	431	52,6	1	-
2513 2690 15	450	40,9	202	476	70,2	1	-
2513 2790 15	500	45,4	225	525	90,3	1	-

BR PE100 T-Stück 90° lang **SDR17** schwarz
BR PE100 Tee 90° long **SDR17** black

Art Nr Art No	D [mm]	e	L	z	KG	VE1 PU1	VE2 PU2
2514 1190 15	63	3,8	67	114	0,32	5	20
2514 1290 15	75	4,5	73	121	0,48	1	10
2514 1390 15	90	5,4	82	153	0,84	1	8
2514 1490 15	110	6,6	98	172	1,33	1	6
2514 1590 15	125	7,4	102	180	1,60	1	3
2514 1690 15	140	8,3	105	195	2,31	1	2
2514 1790 15	160	9,5	124	225	3,45	1	-
2514 1890 15	180	10,7	117	233	4,22	1	-
2514 1990 15	200	11,9	127	253	5,53	1	-
2514 2090 15	225	13,4	136	275	7,90	1	-
2514 2190 15	250	14,8	140	298	10,4	1	-
2514 2290 15	280	16,6	150	325	16,5	1	-
2514 2390 15	315	18,7	160	350	19,8	1	-
2514 2490 15	355	21,1	173	390	24,7	1	-
2514 2590 15	400	23,7	187	431	41,9	1	-
2514 2690 15	450	26,7	202	476	51,4	1	-
2514 2790 15	500	29,7	225	525	64,9	1	-

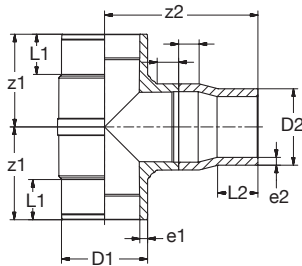

BR PE100 T-Stück 90° red lang Form-B **SDR11** schwarz
BR PE100 Tee 90° red long form-B **SDR11** black

Art Nr Art No	D1-D2 [mm]	e1	e2	L1	L2	z1	z2	KG	VE1 PU1
2523 2421 15	355-250	32,2	22,7	172	143	390	661	42,2	1
2523 2422 15	355-280	32,2	25,4	172	148	390	661	42,9	1
2523 2423 15	355-315	32,2	28,6	172	158	390	661	43,8	1
2523 2522 15	400-280	36,3	25,4	187	153	431	707	56,5	1
2523 2523 15	400-315	36,3	28,6	187	158	431	707	57,4	1
2523 2524 15	400-355	36,3	32,2	187	168	431	707	58,6	1
2523 2724 15	500-355	45,4	32,2	222	172	522	798	102,1	1
2523 2725 15	500-400	45,4	36,3	222	187	522	798	103,7	1
2523 2726 15	500-450	45,4	40,9	222	202	522	798	106,0	1

BR PE100 T-Stück 90° red lang Form-B **SDR17** schwarz
BR PE100 Tee 90° red long form-B **SDR17** black

Art Nr Art No	D1-D2 [mm]	e1	e2	L1	L2	z1	z2	KG	VE1 PU1
2524 2421 15	355-250	21,2	14,8	172	143	390	661	30,1	1
2524 2422 15	355-280	21,1	16,6	172	148	390	661	30,6	1
2524 2423 15	355-315	21,1	18,7	172	158	390	661	31,2	1
2524 2522 15	400-280	23,7	16,6	187	153	431	707	39,7	1
2524 2523 15	400-315	23,7	18,7	187	158	431	707	40,3	1
2524 2524 15	400-355	23,7	21,1	187	168	431	707	41,2	1
2524 2724 15	500-355	29,7	21,1	222	172	522	798	71,5	1
2524 2725 15	500-400	29,7	23,7	222	187	522	798	72,6	1
2524 2726 15	500-450	29,7	26,7	222	202	522	798	74,1	1

Form B = T-Stück egal mit angeschweißter Reduktion.
Form B = Tee equal with welded Reducer.



2.02.02 T-Stücke, Abzweige lang • Tee's, Branches long

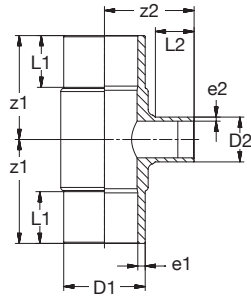

BR PE100 T-Stück 90° red lang **SDR11** schwarz

BR PE100 Tee 90° red long **SDR11** black

Art Nr	D1-D2	e1	e2	L1	L2	z1	z2	KG	VE1	VE2
Art No	[mm]	[mm]		[mm]		[mm]		PU1	PU2	PU2
2523 1108 15	63-32	5,8	3,0	70	46	114	91	0,32	2	20
2523 1311 35	90-63	8,2	5,8	90	74	147	135	0,83	1	-
2523 1411 15	110-63	10,0	5,8	93	65	158	139	1,30	1	5
2523 1413 15	110-90	10,0	8,2	91	83	160	158	1,40	1	4
2523 1511 15	125-63	11,4	5,8	101	70	179	157	1,69	1	4
2523 1512 15	125-75	11,4	6,8	102	76	179	162	1,72	1	4
2523 1513 15	125-90	11,4	8,2	100	86	179	170	1,80	1	4
2523 1514 15	125-110	11,4	10,0	101	96	179	179	1,93	1	4
2523 1611 15	140-63	12,7	5,8	103	69	193	165	2,41	1	3
2523 1612 15	140-75	12,7	6,8	104	77	193	177	2,45	1	3
2523 1612 15	140-90	12,7	8,2	105	85	193	188	2,51	1	3
2523 1614 15	140-110	12,7	10,0	105	88	193	188	2,64	1	2
2523 1711 15	160-63	14,6	5,8	110	72	212	179	3,55	1	-
2523 1712 15	160-75	14,6	6,8	110	71	212	178	3,49	1	-
2523 1713 15	160-90	14,6	8,2	110	85	212	196	3,65	1	-
2523 1714 15	160-110	14,6	10,0	110	93	212	201	3,77	1	-
2523 1812 15	180-75	16,4	6,8	116	77	230	197	4,95	1	-
2523 1813 15	180-90	16,4	8,2	117	85	230	208	4,97	1	-
2523 1814 15	180-110	16,4	10,0	117	98	230	218	4,98	1	-
2523 1815 15	180-125	16,4	11,4	117	100	230	223	5,11	1	-
2523 1816 15	180-140	16,4	12,7	116	105	230	225	5,54	1	-
2523 1817 15	180-160	16,4	14,6	116	112	230	232	5,60	1	-
2523 1911 15	200-63	18,2	5,8	127	72	255	195	6,39	1	-
2523 1912 15	200-75	18,2	6,8	127	80	255	203	6,44	1	-
2523 1913 15	200-90	18,2	8,2	127	87	255	212	6,52	1	-
2523 1914 15	200-110	18,2	10,0	127	97	255	224	6,64	1	-
2523 1915 15	200-125	18,2	11,4	127	104	255	225	6,75	1	-
2523 1917 15	200-160	18,2	14,6	127	112	255	242	7,08	1	-
2523 2011 15	225-63	20,5	5,8	130	68	270	245	8,31	1	-
2523 2012 15	225-75	20,5	6,8	130	75	270	251	8,33	1	-
2523 2013 15	225-90	20,5	8,2	130	87	270	264	8,40	1	-
2523 2014 15	225-110	20,5	10,0	128	92	261	268	8,62	1	-
2523 2015 15	225-125	20,5	11,4	130	92	261	267	8,72	1	-
2523 2016 15	225-140	20,5	12,7	130	105	270	280	8,88	1	-
2523 2017 15	225-160	20,5	14,6	120	110	261	248	8,92	1	-
2523 2113 15	250-90*	22,7	8,2	145	85	298	235	10,30	1	-
2523 2114 15	250-110	22,7	10,0	145	100	298	265	10,3	1	-
2523 2115 15	250-125*	22,7	11,4	145	115	298	270	10,7	1	-
2523 2117 15	250-160*	22,7	14,6	145	118	298	275	10,7	1	-
2523 2214 15	280-110*	25,4	10,0	146	95	321	260	14,0	1	-
2523 2217 15	280-160	25,4	14,6	146	110	321	280	14,4	1	-
2523 2314 15	315-110*	28,6	10,0	165	100	352	291	19,2	1	-
2523 2317 15	315-160	28,6	14,6	165	110	352	305	19,4	1	-
2523 2321 15	315-250*	28,6	22,7	165	137	352	328	20,8	1	-
2523 2322 15	315-280	28,6	25,4	165	150	352	340	22,0	1	-

* In Vorbereitung • Under preparation.

BR PE100 T-Stück 90° red lang **SDR17** schwarz

BR PE100 Tee 90° red long **SDR17** black

Art Nr	D1-D2	e1	e2	L1	L2	z1	z2	KG	VE1	VE2
Art No	[mm]	[mm]		[mm]		[mm]		PU1	PU2	PU2
2524 1108 15	63-32	3,8	3,0**	70	46	114	91	0,28	2	20
2524 1411 15	110-63	6,6	5,8**	93	65	158	139	1,11	1	5
2524 1413 15	110-90	6,6	5,4	91	83	160	158	1,18	1	4
2524 1511 15	125-63	7,4	5,8**	101	70	179	157	1,13	1	4
2524 1512 15	125-75	7,4	4,5	102	76	179	162	1,37	1	4
2524 1513 15	125-90	7,4	5,4	100	86	179	170	1,41	1	4
2524 1514 15	125-110	7,4	6,6	101	96	179	179	1,51	1	4
2524 1611 15	140-63	8,3	5,8**	103	69	193	165	1,94	1	3
2524 1612 15	140-75	8,3	4,5	104	77	193	177	1,99	1	3
2524 1612 15	140-90	8,3	5,4	105	85	193	188	2,01	1	3
2524 1614 15	140-110	8,3	6,6	105	88	193	188	2,09	1	2
2524 1711 15	160-63	9,5	5,8**	110	72	212	179	2,87	1	-
2524 1712 15	160-75	9,5	4,5	110	71	212	178	2,88	1	-
2524 1713 15	160-90	9,5	5,4	110	85	212	196	2,92	1	-
2524 1714 15	160-110	9,5	6,6	110	93	212	201	3,00	1	-
2524 1812 15	180-75	10,7	4,5	116	77	230	197	3,92	1	-
2524 1813 15	180-90	10,7	5,4	117	85	230	208	3,95	1	-
2524 1814 15	180-110	10,7	6,6	117	98	230	218	4,03	1	-
2524 1815 15	180-125	10,7	7,4	117	100	230	223	4,10	1	-
2524 1816 15	180-140	10,7	8,3	116	105	230	225	4,19	1	-
2524 1817 15	180-160	10,7	9,5	116	112	230	232	4,44	1	-
2524 1911 15	200-63	11,9	5,8**	127	72	255	195	5,13	1	-
2524 1912 15	200-75	11,9	4,5	127	80	255	203	5,15	1	-
2524 1913 15	200-90	11,9	5,4	127	87	255	212	5,22	1	-
2524 1914 15	200-110	11,9	6,6	127	97	255	224	5,25	1	-
2524 1915 15	200-125	11,9	7,4	127	104	255	225	5,38	1	-
2524 1917 15	200-160	11,9	9,5	127	112	255	242	5,65	1	-
2524 2011 15	225-63	13,4	5,8**	130	68	270	245	6,69	1	-
2524 2012 15	225-75	13,4	4,5	130	75	270	251	6,71	1	-
2524 2013 15	225-90	13,4	5,4	130	87	270	264	6,77	1	-
2524 2014 15	225-110	13,4	6,6	128	92	261	268	6,97	1	-
2524 2015 15	225-125	13,4	7,4	130	92	261	267	6,98	1	-
2524 2016 15	225-140	13,4	8,3	130	105	270	280	7,17	1	-
2524 2017 15	225-160	13,4	9,5	120	110	261	248	7,20	1	-
2524 2113 15	250-90*	14,8	5,4	145	85	298	235	7,30	1	-
2524 2114 15	250-110*	14,8	6,6	145	95	298	265	7,30	1	-
2524 2115 15	250-125*	14,8	7,4	145	115	298	270	7,60	1	-
2524 2117 15	250-160*	14,8	9,5	145	100	298	275	7,60	1	-
2524 2214 15	280-110*	16,6	6,6	146	95	321	260	9,90	1	-
2524 2217 15	280-160*	16,6	9,5	146	118	321	280	10,1	1	-
2524 2314 15	315-110*	18,7	6,6	165	100	352	291	13,6	1	-
2524 2317 15	315-160*	18,7	9,5	165	110	352	305	14,6	1	-
2524 2321 15	315-250*	18,7	14,8	165	137	352	328	15,2	1	-

** SDR11

* In Vorbereitung • Under preparation.



2.02.02 T-Stücke, Abzweige lang • Tee's, Branches long

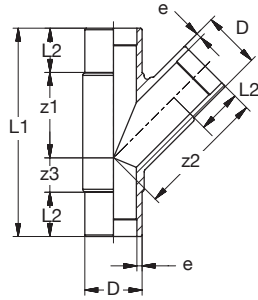

BR PE100 Abzweig 45° lang **SDR11** schwarz
BR PE100 Branch 45° long **SDR11** black

Art Nr	D	e	L1	L2	z1	z2	z3	KG	VE1	VE2
Art No	[mm]		[mm]						PU1	PU2
2513 0945 15	40	3,7	189	45	75	75	20	0,16	2	40
2513 1045 15	50	4,6	222	55	90	90	23	0,29	2	28
2513 1145 15	63	5,8	244	63	96	93	23	0,47	2	16
2513 1245 15	75	6,8	290	75	105	107	34	0,55	1	10
2513 1345 15	90	8,2	371	85	149	149	51	1,45	1	5
2513 1445 15	110	10,0	400	85	164	164	55	2,24	1	3
2513 1545 15	125	11,4	447	105	185	185	45	3,31	1	-
2513 1745 15	160	14,6	538	115	260	260	50	6,26	1	-
2513 1845 15	180	16,4	580	116	268	272	75	8,65	1	-
2513 1945 15	200	18,2	633	122	287	286	94	11,7	1	-
2513 2045 15	225	20,5	700	135	350	350	85	16,3	1	-
2513 2145 15	250	22,7	792	143	397	397	109	22,5	1	-
2513 2245 15	280*	25,4	852	146	440	440	120	31,1	1	-
2513 2345 15	315	28,6	965	165	497	497	138	44,4	1	-

* In Vorbereitung • Under preparation

BR PE100 Abzweig 45° lang **SDR17** schwarz
BR PE100 Branch 45° long **SDR17** black

Art Nr	D	e	L1	L2	z1	z2	z3	KG	VE1	VE2
Art No	[mm]		[mm]						PU1	PU2
2514 0945 15	40	2,4	189	45	75	75	20	0,14	2	40
2514 1045 15	50	3,0	222	55	90	90	23	0,23	2	28
2514 1145 15	63	3,8	244	63	96	93	23	0,44	2	16
2514 1245 15	75	4,5	290	75	105	107	34	0,59	1	12
2514 1345 15	90	5,4	371	85	149	149	51	1,25	1	5
2514 1445 15	110	6,6	400	85	164	164	55	1,50	1	3
2514 1545 15	125	7,4	447	105	185	185	45	2,86	1	-
2514 1745 15	160	9,5	538	115	260	260	50	5,62	1	-
2514 1845 15	180	10,7	580	116	268	272	75	7,75	1	-
2514 1945 15	200	11,9	633	122	287	286	94	10,2	1	-
2514 2045 15	225	13,4	700	135	350	350	85	14,8	1	-
2514 2145 15	250	14,8	792	143	397	397	109	16,9	1	-
2514 2245 15	280*	16,6	852	146	440	440	120	23,4	1	-
2514 2345 15	315	18,7	965	165	494	494	138	33,4	1	-

* In Vorbereitung • Under preparation

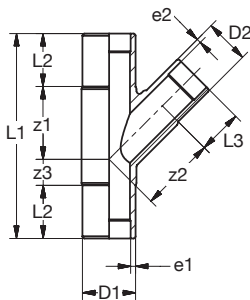

BR PE100 Abzweig 45° red lang **SDR17(-11)** schwarz
BR PE100 Branch 45° red long **SDR17(-11)** black

Art Nr	D1-D2	e1	e2	L1	L2	L3	z1	z2	z3	KG	VE1	VE2
Art No	[mm]			[mm]							PU1	PU2
2534 1211 15	75-63	4,5	5,8*	290	75	63	102	102	37	0,58	1	12

* SDR11

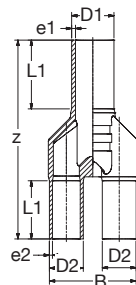

BR PE100 Hosenstück lang **SDR11** schwarz
BR PE100 Y-piece long **SDR11** black

Art Nr	D1-D2	e1	e2	L1	L2	z	B	KG	VE1	VE2
Art No	[mm]			[mm]					PU1	PU2
2543 0908 15	40-32	3,7	2,9	65	55	188	82	0,11	1	
2543 1009 15	50-40	4,6	3,7	75	65	228	101	0,22	1	

Nur für Erdsondenanwendung • Only for geothermal use.

2.02.03 Reduktionen, Kappen lang • Reducers, Caps long

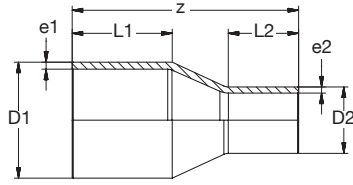

BR PE100 Reduktion lang **SDR11** schwarz

BR PE100 Reducer long **SDR11** black

Art Nr	D1-D2	e1	e2	L1	L2	z	KG	VE1	VE2
Art No	[mm]	[mm]		[mm]				PU1	PU2
2323 0807 15	32-25	3,0	2,3	44	37	89	0,020	10	60
2323 0906 35	40-20	3,7	1,9	45	36	94	0,030	10	40
2323 0907 15	40-25	3,7	2,3	47	35	96	0,032	10	40
2323 0908 15	40-32	3,7	2,9	50	39	93	0,036	10	30
2323 1007 15	50-25	4,6	2,3	62	48	136	0,060	10	110
2323 1008 15	50-32	4,6	2,9	61	50	134	0,066	10	110
2323 1009 15	50-40	4,6	3,7	61	56	134	0,075	10	100
2323 1107 35	63-25	5,8	2,3	64	57	140	0,090	5	60
2323 1108 15	63-32	5,8	2,9	69	50	150	0,11	4	60
2323 1109 15	63-40	5,8	3,7	69	55	152	0,12	4	60
2323 1110 15	63-50	5,8	4,6	69	60	151	0,14	5	50
2323 1209 15	75-40	6,8	3,7	76	55	172	0,20	1	50
2323 1210 15	75-50	6,8	4,6	76	61	172	0,14	1	40
2323 1211 15	75-63	6,8	5,8	76	69	172	0,22	1	36
2323 1310 15	90-50	8,2	4,6	85	60	175	0,27	1	36
2323 1311 15	90-63	8,2	5,8	85	71	178	0,30	1	36
2323 1312 15	90-75	8,2	6,8	85	80	181	0,34	1	34
2323 1410 35	110-50	10,0	4,6	88	57	177	0,39	1	14
2323 1411 15	110-63	10,0	5,8	95	70	212	0,49	1	14
2323 1412 15	110-75	10,0	6,8	95	79	215	0,49	1	14
2323 1413 15	110-90	10,0	8,2	95	88	215	0,58	1	12
2323 1511 15	125-63	11,4	5,8	99	66	226	0,63	1	12
2323 1512 15	125-75	11,4	6,8	100	75	227	0,67	1	10
2323 1513 15	125-90	11,4	8,2	100	74	225	0,72	1	9
2323 1514 15	125-110	11,4	10,0	100	80	228	0,82	1	9
2323 1612 15	140-75	12,7	6,8	116	72	246	0,85	1	9
2323 1613 15	140-90	12,7	8,2	116	85	248	0,92	1	9
2323 1614 15	140-110	12,7	10,0	105	95	250	1,04	1	7
2323 1615 15	140-125	12,7	11,4	105	105	253	1,17	1	7
2323 1713 15	160-90	14,6	8,2	111	84	260	1,20	1	8
2323 1714 15	160-110	14,6	10,0	112	94	260	1,34	1	8
2323 1715 15	160-125	14,6	11,4	111	98	260	1,42	1	8
2323 1716 15	160-140	14,6	12,7	111	105	260	1,57	1	7
2323 1813 35	180-90	16,4	8,2	110	90	260	1,41	1	6
2323 1814 15	180-110	16,4	10,0	115	95	275	1,60	1	6
2323 1815 15	180-125	16,4	11,4	116	105	275	1,77	1	6
2323 1816 35	180-140	16,4	12,7	105	96	221	1,61	1	4
2323 1817 15	180-160	16,4	14,6	117	110	275	2,07	1	4
2323 1914 35	200-110	18,2	10,0	126	96	287	1,90	1	2
2323 1915 15	200-125	18,2	11,4	124	110	281	2,21	1	2
2323 1917 15	200-160	18,2	14,6	124	110	278	2,44	1	2
2323 1918 35	200-180	18,2	16,4	117	109	236	2,30	1	2
2323 2013 35	225-90	20,5	8,2	130	90	300	2,52	1	2
2323 2014 15	225-110	20,5	10,0	132	90	311	2,91	1	2
2323 2015 35	225-125	20,5	11,4	130	100	310	2,81	1	2
2323 2017 15	225-160	20,5	14,6	132	110	310	3,02	1	2
2323 2018 15	225-180	20,5	16,4	140	115	310	3,50	1	-
2323 2019 35	225-200	20,5	18,2	132	130	277	3,47	1	-

Art Nr	D1-D2	e1	e2	L1	L2	z	KG	VE1	VE2
Art No	[mm]	[mm]		[mm]				PU1	PU2
2323 2118 15	250-180	22,7	16,4	140	120	338	4,32	1	-
2323 2119 15	250-200	22,7	18,2	140	125	335	4,65	1	-
2323 2120 15	250-225	22,7	20,5	140	125	335	5,09	1	-
2323 2218 15	280-180	25,4	16,4	150	120	357	5,49	1	36
2323 2219 15	280-200	25,4	18,2	150	125	357	5,81	1	36
2323 2220 15	280-225	25,4	20,5	150	132	357	6,16	1	24
2323 2221 15	280-250	25,4	22,7	150	145	355	6,70	1	24
2323 2320 15	315-225	28,6	20,5	160	142	392	7,78	1	24
2323 2321 15	315-250	28,6	22,7	160	145	392	8,33	1	24
2323 2322 15	315-280	28,6	25,4	160	157	392	9,09	1	18
2323 2421 15	355-250	32,2	22,7	175	145	426	10,9	1	24
2323 2422 15	355-280	32,2	25,4	170	155	426	11,7	1	16
2323 2423 15	355-315	32,2	28,6	175	170	426	12,7	1	16
2323 2522 15	400-280	36,3	25,4	190	155	465	14,8	1	12
2323 2523 15	400-315	36,3	28,6	190	165	460	15,6	1	12
2323 2524 15	400-355	36,3	32,2	190	185	463	17,0	1	12
2323 2623 15	450-315	40,9	28,6	202	157	480	19,5	1	10
2323 2624 15	450-355	40,9	32,2	202	172	480	20,9	1	10
2323 2625 15	450-400	40,9	36,3	202	187	480	22,8	1	10
2323 2724 15	500-355	45,4	32,2	222	172	520	28,5	1	-
2323 2725 15	500-400	45,4	36,3	222	187	520	29,0	1	-
2323 2726 15	500-450	45,4	40,9	222	202	520	32,5	1	-
2323 2924 15	630-355	57,2	32,2	265	172	650	49,3	1	-
2323 2925 15	630-400	57,2	36,3	265	187	650	51,0	1	-
2323 2926 15	630-450	57,2	40,9	265	202	650	53,7	1	-
2323 2927 15	630-500	57,2	45,4	265	222	650	56,6	1	-



2.02.03 Reduktionen, Kappen lang • Reducers, Caps long

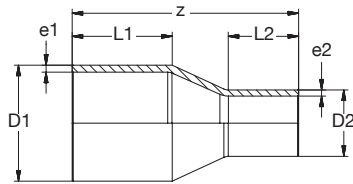

BR PE100 Reduktion lang **SDR17** schwarz

BR PE100 Reducer long **SDR17** black

Art Nr	D1-D2	e1	e2	L1	L2	z	KG	VE1	VE2
Art No	[mm]	[mm]		[mm]				PU1	PU2
2324 1209 15	75-40	4,5	3,7*	76	55	172	0,16	1	50
2324 1210 15	75-50	4,5	4,6*	76	61	172	0,17	1	40
2324 1211 15	75-63	4,5	5,8*	76	69	172	0,18	1	36
2324 1310 15	90-50	5,4	4,6*	85	60	175	0,20	1	36
2324 1311 15	90-63	5,4	5,8*	85	71	178	0,24	1	36
2324 1312 15	90-75	5,4	4,5	85	80	181	0,23	1	34
2324 1410 35	110-50	6,6	3,0	88	57	177	0,27	1	14
2324 1411 15	110-63	6,6	5,8*	95	70	212	0,36	1	14
2324 1412 15	110-75	6,6	4,5	95	79	215	0,35	1	14
2324 1413 15	110-90	6,6	5,4	95	88	215	0,38	1	12
2324 1511 15	125-63	7,4	5,8*	99	66	226	0,46	1	12
2324 1512 15	125-75	7,4	4,5	100	75	227	0,45	1	12
2324 1513 15	125-90	7,4	5,4	100	74	225	0,48	1	9
2324 1514 15	125-110	7,4	6,6	100	80	228	0,57	1	9
2324 1612 15	140-75	8,3	4,5	116	72	246	0,61	1	9
2324 1613 15	140-90	8,3	5,4	116	85	248	0,64	1	9
2324 1614 15	140-110	8,3	6,6	105	95	250	0,72	1	7
2324 1615 15	140-125	8,3	7,4	105	105	253	0,79	1	7
2324 1713 15	160-90	9,5	5,4	111	84	260	0,84	1	8
2324 1714 15	160-110	9,5	6,6	112	94	260	0,91	1	8
2324 1715 15	160-125	9,5	7,4	111	98	260	0,95	1	8
2324 1716 15	160-140	9,5	8,3	111	105	260	1,03	1	7
2324 1813 35	180-90	10,7	5,4	110	90	260	0,98	1	6
2324 1814 15	180-110	10,7	6,6	115	95	275	1,09	1	6
2324 1815 15	180-125	10,7	7,4	116	105	275	1,20	1	6
2324 1816 35	180-140	10,7	8,3	105	96	221	1,05	1	4
2324 1817 15	180-160	10,7	9,5	117	110	275	1,83	1	4
2324 1914 35	200-110	11,9	6,6	126	96	287	1,30	1	2
2324 1915 15	200-125	11,9	7,4	124	110	281	1,97	1	2
2324 1917 15	200-160	11,9	9,5	124	110	278	1,70	1	2
2324 1918 35	200-180	11,9	10,7	117	109	236	1,20	1	2
2324 2013 35	225-90	13,4	5,4	121	89	298	1,80	1	2
2324 2014 15	225-110	13,4	6,6	132	90	311	2,62	1	2
2324 2015 35	225-125	13,4	7,4	131	100	288	1,90	1	2
2324 2017 15	225-160	13,4	9,5	132	110	310	2,22	1	2
2324 2018 15	225-180	13,4	10,7	140	115	310	2,37	1	-
2324 2019 35	225-200	13,4	11,9	140	130	277	2,38	1	-
2324 2117 15	250-160	14,8	9,5	140	110	338	3,64	1	-
2324 2118 15	250-180	14,8	10,7	140	120	338	3,79	1	-
2324 2119 15	250-200	14,8	11,9	140	125	335	4,00	1	-
2324 2120 15	250-225	14,8	13,4	140	125	335	4,45	1	-
2324 2218 15	280-180	16,6	10,7	150	120	357	4,77	1	36
2324 2219 15	280-200	16,6	11,9	150	125	357	5,00	1	36
2324 2220 15	280-225	16,6	13,4	150	132	357	5,35	1	24
2324 2221 15	280-250	16,6	14,8	150	145	355	5,93	1	24
2324 2320 15	315-225	18,7	13,4	160	142	392	6,92	1	24
2324 2321 15	315-250	18,7	14,8	160	145	392	7,38	1	24
2324 2322 15	315-280	18,7	16,6	160	157	392	7,92	1	18

Art Nr	D1-D2	e1	e2	L1	L2	z	KG	VE1	VE2
Art No	[mm]	[mm]		[mm]				PU1	PU2
2324 2421 15	355-250	21,1	14,8	175	145	426	9,60	1	24
2324 2422 15	355-280	21,1	16,6	170	155	426	10,2	1	16
2324 2423 15	355-315	21,1	18,7	175	170	426	11,1	1	16
2324 2522 15	400-280	23,7	16,6	190	155	465	13,2	1	12
2324 2523 15	400-315	23,7	18,7	190	165	460	13,9	1	12
2324 2524 15	400-355	23,7	21,1	190	185	463	15,0	1	12
2324 2623 15	450-315	26,7	18,7	202	157	480	17,7	1	10
2324 2624 15	450-355	26,7	21,1	202	172	480	14,2	1	10
2324 2625 15	450-400	26,7	23,7	202	187	480	15,5	1	10
2324 2724 15	500-355	29,7	21,1	222	172	520	18,4	1	-
2324 2725 15	500-400	29,7	23,7	222	187	520	19,5	1	-
2324 2726 15	500-450	29,7	26,7	222	202	520	21,2	1	-
2324 2924 15	630-355	37,4	21,1	265	172	650	33,5	1	-
2324 2925 15	630-400	37,4	23,7	265	187	650	34,8	1	-
2324 2926 15	630-450	37,4	26,7	265	202	650	36,5	1	-
2324 2927 15	630-500	37,4	29,7	265	222	650	38,5	1	-

* SDR11

* SDR11

2.02.03 Reduktionen, Kappen lang • Reducers, Caps long

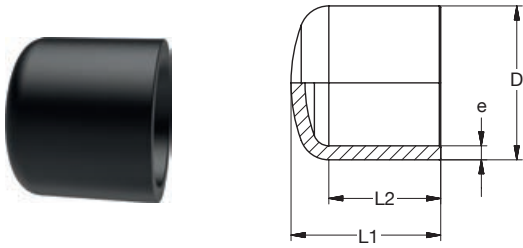

BR PE100 Kappe lang **SDR11** schwarz

BR PE100 Cap long **SDR11** black

Art Nr	D	e	L	L2	KG	VE1	VE2
Art No	[mm]		[mm]			PU1	PU2
2443 0700 15	25	2,3	52	46	0,010	10	150
2443 0800 15	32	3,0	57	48	0,017	10	90
2443 0900 15	40	3,7	68	56	0,030	10	240
2443 1000 15	50	4,6	74	58	0,053	10	140
2443 1100 15	63	5,8	80	66	0,085	5	60
2443 1200 15	75	6,8	80	67	0,14	2	70
2443 1300 15	90	8,2	91	73	0,22	1	40
2443 1400 15	110	10,0	107	82	0,38	1	24
2443 1500 15	125	11,4	125	94	0,55	1	18
2443 1600 15	140	12,7	138	110	0,79	1	12
2443 1700 15	160	14,6	152	120	1,12	1	8
2443 1800 15	180	16,4	168	132	1,59	1	2
2443 1900 15	200	18,2	184	143	2,16	1	2
2443 2000 15	225	20,5	202	163	2,96	1	2
2443 2100 15	250	22,7	218	170	3,29	1	-
2443 2200 15	280	25,4	227	182	4,80	1	-
2443 2300 15	315	28,6	245	190	6,28	1	-
2443 2400 15	355	32,2	264	213	9,09	1	-
2443 2500 15	400	36,3	280	230	12,5	1	-
2443 2600 15	450	40,9	306	195	17,0	1	-
2443 2700 15	500	45,4	335	212	22,9	1	-
2443 2900 15	630	57,2	410	255	44,7	1	-

BR PE100 Kappe lang **SDR17** schwarz

BR PE100 Cap long **SDR17** black

Art Nr	D	e	L	L2	KG	VE1	VE2
Art No	[mm]		[mm]			PU1	PU2
2444 1100 15	63	3,8	80	66	0,060	5	60
2444 1200 15	75	4,5	80	67	0,090	2	70
2444 1300 15	90	5,4	91	73	0,15	1	40
2444 1400 15	110	6,6	107	82	0,26	1	24
2444 1500 15	125	7,4	125	94	0,39	1	18
2444 1600 15	140	8,3	138	110	0,54	1	12
2444 1700 15	160	9,5	152	120	0,78	1	8
2444 1800 15	180	10,7	168	132	1,08	1	2
2444 1900 15	200	11,9	184	143	1,49	1	2
2444 2000 15	225	13,4	202	163	2,05	1	2
2444 2100 15	250	14,8	218	170	2,90	1	-
2444 2200 15	280	16,6	227	182	3,86	1	-
2444 2300 15	315	18,7	245	190	4,62	1	-
2444 2400 15	355	21,1	264	213	6,29	1	-
2444 2500 15	400	23,7	280	230	8,43	1	-
2444 2600 15	450	26,7	306	195	11,8	1	-
2444 2700 15	500	29,7	335	212	15,9	1	-
2444 2900 15	630	37,4	410	255	31,0	1	-

2.02.04 Übergänge lang • Transitions long

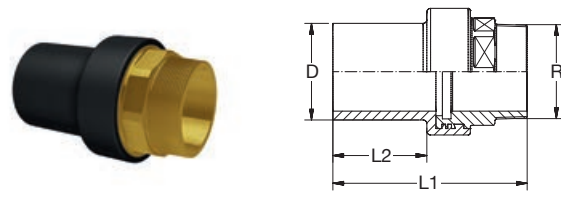
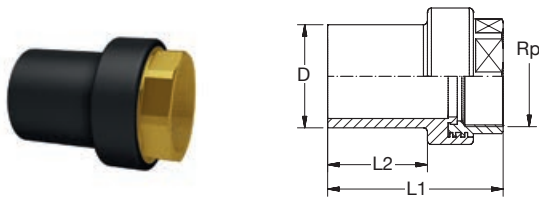

BR PE100-Messing Übergang lang IG-zyl **SDR11** schwarz

BR PE100-Brass Transition long female-thread-cyl **SDR11** black

Art Nr Art No	D x Rp [mm]	e	L1	L2	KG	VE1 PU1	VE2 PU2
2M13 0643 35	20 x 1/2	3,0	80	41	0,08	1	80
2M13 0745 35	25 x 3/4	3,0	80	44	0,12	1	60
2M13 0846 35	32 x 1	3,0	90	47	0,20	1	35
2M13 0947 35	40 x 1 1/4	3,7	100	56	0,30	1	20
2M13 1048 35	50 x 1 1/2	4,6	100	57	0,35	1	16
2M13 1150 35	63 x 2	5,8	120	63	0,58	1	10
2M13 1253 35	75 x 2 1/2	6,8	130	70	0,75	1	14
2M13 1355 35	90 x 3	8,2	145	78	1,00	1	10
2M13 1457 35	110 x 4	10,0	160	87	1,90	1	6
2M13 1557 35	125 x 4	11,4	160	92	2,00	1	4

CW612N (CuZn39Pb2 - 2.0380)

BR PE100-Messing Übergang lang AG-keg **SDR11** schwarz

BR PE100-Brass Transition long male-thread-con **SDR11** black

Art Nr Art No	D x R [mm]	e	L1	L2	KG	VE1 PU1	VE2 PU2
2M13 0673 35	20 x 1/2	3,0	95	41	0,10	1	70
2M13 0775 35	25 x 3/4	3,0	90	44	0,15	1	60
2M13 0876 35	32 x 1	3,0	105	56	0,25	1	30
2M13 0977 35	40 x 1 1/4	3,7	105	56	0,40	1	20
2M13 1078 35	50 x 1 1/2	4,6	125	57	0,52	1	16
2M13 1180 35	63 x 2	5,8	140	63	0,73	1	9
2M13 1283 35	75 x 2 1/2	6,8	155	70	1,20	1	14
2M13 1385 35	90 x 3	8,2	170	78	1,60	1	6
2M13 1487 35	110 x 4	10,0	200	87	2,90	1	4
2M13 1587 35	125 x 4	11,4	200	92	2,90	1	4

CW612N (CuZn39Pb2 - 2.0380)

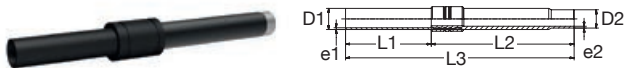

BR PE100-Stahl Übergang (ohne Gewinde) **SDR11** schwarz

BR PE100-Steel Transition (without thread) **SDR11** black

Art Nr Art No	D1 x D2 [mm]	e1	e2	L1	L2	L3	KG	VE1 PU1
2S13 0700 35	25 x 3/4	2,6	3,0	160	335	495	0,7	1
2S13 0800 35	32 x 1	3,2	3,0	160	335	495	1,0	1
2S13 0900 35	40 x 1 1/4	3,2	3,7	160	335	495	1,3	1
2S13 1000 35	50 x 1 1/2	3,2	4,6	160	335	495	1,5	1
2S13 1100 35	63 x 2	3,6	5,8	185	335	520	2,4	1
2S13 1200 35	75 x 2 1/2	3,6	6,8	190	335	525	3,4	1
2S13 1300 35	90 x 3	4,0	8,2	190	335	525	4,0	1
2S13 1400 35	110 x 4	4,5	10,0	190	335	525	6,2	1
2S13 1500 35	125 x 4	4,5	11,4	190	335	525	6,6	1
2S13 1600 35	140 x 5	5,0	12,7	200	400	600	10,5	1
2S13 1700 35	160 x 6	5,0	14,6	200	450	650	13,4	1
2S13 1800 35	180 x 6	5,0	16,4	200	450	650	13,8	1
2S13 1900 35	200 x 8	5,6	18,2	200	500	700	21,9	1
2S13 2000 35	225 x 8	5,6	20,5	200	500	700	23,5	1
2S13 2100 35	250 x 10	6,3	22,7	300	580	880	32,7	1
2S13 2200 35	280 x 10	6,3	25,4	300	580	880	39,2	1
2S13 2300 35	315 x 12	8,0	28,6	350	580	930	60,4	1

2.02.05 Verschraubungen lang • Unions long

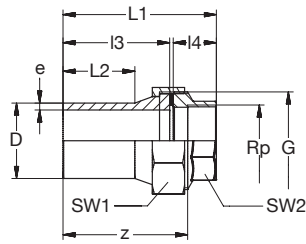

BR PE100-V2A Ü-Verschraubung lang IG-zyl Flachdichtung-EPDM **SDR11** schwarz

BR PE100-Stainless steel Transition-Union long female-thread-cyl **SDR11** black

Art Nr Art No	D x Rp [mm x Inch]	e [mm]	G [Inch]	L1	L2	l1	l2	z	SW2	SW2	KG	VE1 PU1
				[mm]								
2V53 0745 15	25 x 3/4	2,3	1 1/4	82	36	56	23	67	47	31	0,23	1
2V53 0846 15	32 x 1	3,0	1 1/2	94	42	65	26	77	53	38	0,28	1
2V53 0947 15	40 x 1 1/4	3,7	2	102	45	71	28	83	66	47	0,45	1
2V53 1048 15	50 x 1 1/2	4,6	2 1/4	113	52	81	29	94	72	53	0,61	1
2V53 1150 15	63 x 2	5,8	2 3/4	126	57	89	34	102	89	66	1,07	1
2V53 1253 15	75 x 2 1/2	6,8	3 1/2	179	71	130	46	152	109	82	1,67	1
2V53 1355 15	90 x 3	8,2	4	205	76	150	52	175	123	96	2,29	1
2V53 1357 15	90 x 4	8,2	5	219	76	164	60	180	150	124	3,10	1
2V53 1457 15	110 x 4	10,0	5	233	88	170	60	197	150	124	3,56	1

V2A = 1.4305

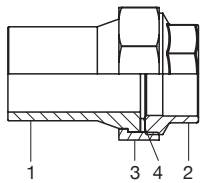

Verschraubung PE-V2A mit Flachdichtung und Anschluss für Metallgewinde

1. PE Einlegteil
2. V2A Schraubteil
3. V2A Überwurfmutter
4. Flachdichtring-EPDM

Union PE-Stainless steel with flat-gasket and connection for metal thread

1. PE Insert-part
2. Stainless steel Screw-part
3. Stainless steel Union-nut
4. Flat-gasket-EPDM

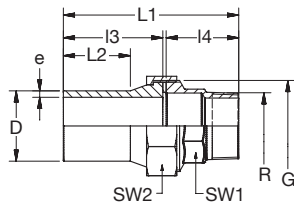

BR PE100-V2A Ü-Verschraubung lang AG-keg Flachdichtring-EPDM **SDR11** schwarz

BR PE100-Stainless steel Transition-Union long male-thread-con flat-gasket-EPDM **SDR11** black

Art Nr Art No	D x R [mm x Inch]	e [mm]	G [Inch]	L1	L2	l1	l2	SW2	SW2	KG	VE1 PU1
				[mm]							
2V53 0775 15	25 x 3/4	2,3	1 1/4	109	36	56	50	47	31	0,26	1
2V53 0876 15	32 x 1	3,0	1 1/2	122	42	65	54	53	38	0,38	1
2V53 0977 15	40 x 1 1/4	3,7	2	128	45	71	54	66	47	0,59	1
2V53 1078 15	50 x 1 1/2	4,6	2 1/4	146	52	81	62	72	53	0,77	1
2V53 1180 15	63 x 2	5,8	2 3/4	161	57	89	69	89	66	1,19	1
2V53 1283 15	75 x 2 1/2	6,8	3 1/2	152	71	130	78	109	82	2,02	1
2V53 1385 15	90 x 3	8,2	4	240	76	150	87	123	96	2,61	1
2V53 1387 15	90 x 4	8,2	5	257	76	164	100	150	124	3,90	1
2V53 1487 15	110 x 4	10,0	5	273	88	170	100	150	124	4,44	1

V2A = 1.4305

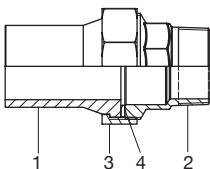

Verschraubung PE-V2A mit Flachdichtung und Anschluss für Metallgewinde

1. PE Einlegteil
2. V2A Schraubteil
3. V2A Überwurfmutter
4. Flachdichtring-EPDM

Union PE-Stainless steel with flat-gasket and connection for metal thread

1. PE Insert-part
2. Stainless steel Screw-part
3. Stainless steel Union-nut
4. Flat-gasket-EPDM

2.02.05 Verschraubungen lang • Unions long

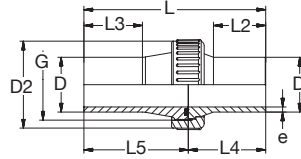

BR PE100 Verschraubung lang mit Runddichtring-EPDM **SDR11** schwarz

BR PE100 Union long with O-Ring-gasket-EPDM **SDR11** black

Art Nr	D	e	D1	D2	G	L	L2	L3	L4	L5	L6	H1	H2	KG	VE1
Art No	[mm]		[mm]		[Inch]	[mm]								PU1	
2353 0700 15	25	2,3	38,8	52	1 1/4	177	60	60	89	88	25	6	11	0,073	1
2353 0800 15	32	3,0	44,7	60	1 1/2	190	60	60	95	95	27	7	14	0,10	1
2353 0900 15	40	3,7	56,5	74	2	185	66	66	96	89	30	8	15	0,17	1
2353 1000 15	50	4,6	62,2	83	2 1/4	230	80	80	115	115	34	8	15	0,23	1
2353 1100 15	63	5,8	78,4	103	2 3/4	249	85	85	124	125	38	9	17	0,38	1
2353 1200 15	75	6,9	97,2	121	3 1/2	260	90	90	130	130	43	11	17	0,72	1
2353 1300 15	90	8,2	110	137	4	288	103	103	144	144	45	13	19	1,06	1
2353 1400 15	110	10,0	135,3	164	5	309	105	105	154	154	51	13	20	1,62	1

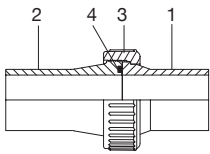

Verschraubung PE mit Runddichtring und beiseitigen Schweißenden

1. PE Einlegeteil
2. PE Schraubenteil
3. PVC Überwurfmutter
4. Runddichtring-EPDM/FKM

Union PE with O-Ring-gasket and spigots on both sides

1. PE Insert-part
2. PE Screw-part
3. PVC Union-nut
4. O-Ring-gasket-EPDM/FKM

Einzelteile • Spare parts

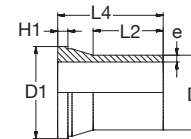
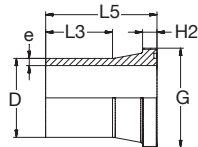

BR PE 100 Schraubenteil lang • Screw part long

D [mm]	Art Nr	KG	VE1	VE2
	Art No		PU1	PU2
25	2353 07S0 15	0,026	1	300
32	2353 08S0 15	0,039	1	100
40	2353 09S0 15	0,062	1	140
50	2353 10S0 05	0,10	1	80
63	2353 11S0 05	0,17	1	50
75	2353 12S0 05	0,26	1	25
90	2353 13S0 05	0,38	1	30
110	2353 14S0 05	0,61	1	12

BR PE 100 Einlegeteil lang • Insert-part long

D [mm]	Art Nr	KG	VE1	VE2
	Art No		PU1	PU2
25	2353 07E0 15	0,023	1	400
32	2353 08E0 15	0,036	1	250
40	2353 09E0 15	0,062	1	150
50	2353 10E0 15	0,10	1	80
63	2353 11E0 15	0,17	1	60
75	2353 12E0 15	0,26	1	40
90	2353 13E0 15	0,38	1	30
110	2353 14E0 15	0,62	1	18

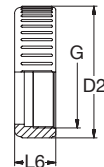

BR Runddichtring • O-Ring - EPDM

D [mm]	Art Nr	KG	VE1
	Art No		PU1
25	9201 07R1 35	0,001	10
32	9205 48R1 35	0,002	10
40	9205 50R1 35	0,003	10
50	9205 51R1 35	0,004	10
63	9205 54R1 35	0,005	10
75	9205 56R1 35	0,010	10
90	9205 57R1 35	0,010	10
110	9205 58R1 35	0,010	10

BR Runddichtring • O-Ring - FKM

D [mm]	Art Nr	KG	VE1
	Art No		PU1
25	9201 07R3 35	0,001	10
32	9205 48R3 35	0,002	10
40	9205 50R3 35	0,003	10
50	9205 51R3 35	0,004	10
63	9205 54R3 35	0,005	10
75	9205 56R3 35	0,010	10
90	9205 57R3 35	0,010	10
110	9205 58R3 35	0,010	10

BR PVC Überwurfmutter • Union nut

D [mm]	Art Nr	KG	VE1	VE2
	Art No		PU1	PU2
25	1350 07U0 15	0,030	1	400
32	1350 08U0 15	0,040	1	300
40	1350 09U0 15	0,090	1	200
50	1350 10U0 15	0,15	1	160
63	1350 11U0 15	0,15	1	80
75	1350 12U0 15	0,21	1	-
90	1350 13U0 15	0,29	1	-
110	1350 14U0 15	0,40	1	-

2.02.06 Flanschverbindung lang • Flange connection long

Vorschweißbund (V-Bund) lang in gerillter Ausführung für den Einsatz von Flachdichtungen.

Weitere Informationen zu Flanschen und Dichtungen finden Sie unter Zubehör.

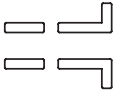

Flange adaptor spigot long grooved for the use of flat-gaskets.

More information about flanges and gaskets see Accessories.

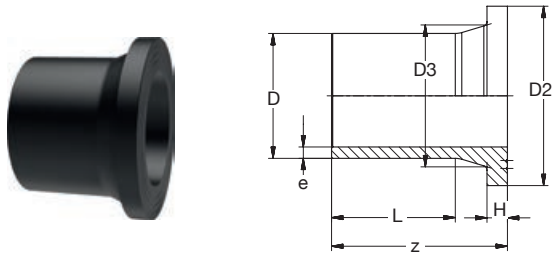

BR PE100 V-Bund lang gerillt **SDR11** schwarz

BR PE100 Flange adaptor spigot long grooved **SDR11** black

Art Nr	D	e	D2	D3	H	L	z	KG	VE1	VE2
Art No	[mm]								PU1	PU2
2333 07F0 15	25	2,3	58	33	9,0	51	90	0,040	10	180
2333 08F0 15	32	3,0	68	40	10,0	57	95	0,060	10	80
2333 09F0 15	40	3,7	78	50	11,0	55	100	0,080	10	60
2333 10F0 15	50	4,6	88	61	12,0	63	110	0,13	10	60
2333 11F0 15	63	5,8	102	75	14,0	78	122	0,21	5	40
2333 12F0 15	75	6,8	122	89	16,0	84	130	0,32	1	18
2333 13F0 15	90	8,2	138	105	17,0	98	142	0,48	1	12
2333 14F0 15	110	10,0	158	125	18,0	102	155	0,71	1	12
2333 15F0 15	125	11,4	158	132	26,0	115	172	0,93	1	8
2333 16F0 15	140	12,7	188	155	25,0	112	172	1,26	1	4
2333 17F0 15	160	14,6	212	175	25,0	122	182	1,66	1	6
2333 18F0 15	180	16,4	212	180	30,0	160	195	1,94	1	4
2333 19F0 15	200	18,2	268	232	32,0	123	205	3,14	1	-
2333 20F0 15	225	20,5	268	235	32,0	143	213	3,40	1	-
2333 21F0 15	250	22,7	320	285	35,0	150	235	5,25	1	-
2333 22F0 15	280	25,4	320	291	35,0	178	255	5,82	1	-
2333 23F0 15	315	28,6	370	335	35,0	172	257	8,05	1	-
2333 24F0 15	355	32,2	430	373	40,0	195	280	11,3	1	-
2333 25F0 15	400	36,3	475	427	46,0	215	315	16,1	1	-
2333 26F0 15	450	40,9	575	514	60,0	196	340	26,0	1	-
2333 27F0 15	500	45,4	575	530	60,0	200	360	29,0	1	-
2333 28F0 35	560	50,8	685	615	60,0	240	380	47,1	1	-
2333 29F0 15	630	57,2	685	642	65,0	250	410	42,3	1	-

BR PE100 V-Bund lang gerillt **SDR17** schwarz

BR PE100 Flange adaptor spigot long grooved **SDR17** black

Art Nr	D	e	D2	D3	H	L	z	KG	VE1	VE2
Art No	[mm]								PU1	PU2
2334 11F0 15	63	3,8	102	75	14	78	122	0,18	5	40
2334 12F0 15	75	4,5	122	89	16	64	130	0,27	1	18
2334 13F0 15	90	5,4	138	105	17	98	142	0,38	1	12
2334 14F0 15	110	6,6	158	125	18	102	155	0,56	1	12
2334 15F0 15	125	7,4	158	132	18	122	172	0,63	1	8
2334 16F0 15	140	8,3	188	155	18	119	172	0,90	1	4
2334 17F0 15	160	9,5	212	175	18	129	182	1,12	1	6
2334 18F0 15	180	10,7	212	180	20	175	195	1,36	1	4
2334 19F0 15	200	11,9	268	232	24	131	205	2,28	1	-
2334 20F0 15	225	13,4	268	235	24	151	213	2,33	1	-
2334 21F0 15	250	14,8	320	285	25	160	235	3,60	1	-
2334 22F0 15	280	16,6	320	291	25	188	255	4,16	1	-
2334 23F0 15	315	18,7	370	335	25	182	257	5,56	1	-
2334 24F0 15	355	21,1	430	373	30	195	280	7,83	1	-
2334 25F0 15	400	23,7	482	427	33	227	315	11,1	1	-
2334 26F0 15	450	26,7	575	514	46	196	340	18,3	1	-
2334 27F0 15	500	29,7	575	530	46	224	360	20,0	1	-
2334 28F0 35	560	33,2	685	615	50	250	370	27,2	1	-
2334 29F0 15	630	37,4	685	642	50	260	410	29,3	1	-



Zubehör Flanschverbindung PE (V-Bund) • Accessories Flange Connection PE (V-Bund)



Losflansch
Flange loose

D [mm]	DN [mm]	PP-St			St beschichtet St coated	PP-GGG	PP-St
		DIN/EN				ANSI	
		PN10/16	PN10	PN16	PN10	150 lbs	
25	20	9141 07E1 15					9141 07A2 38
32	25	9141 08E1 15					9141 08A2 38
40	32	9141 09E1 15					9141 09A2 38
50	40	9141 10E1 15					9141 10A2 38
63	50	9141 11E1 15				9151 11A2 25	
75	65	9141 12E1 15					9141 12A2 38
90	80	9143 13E1 15				9153 13A2 25	
110	100	9143 14E1 15				9153 14A2 25	
125	100	9143 15E1 15					9143 14A2 38
140	125	9143 16E1 15					
160	150	9143 17E1 15				9153 17A2 25	
180	150	9143 18E1 15				9153 18A2 35	
200	200		9143 19E2 15	9143 19E3 35		9153 19A2 25	
225	200		9143 20E2 15	9143 20E3 35		9153 19A2 25	
250	250		9143 21E2 15	9143 21E3 35		9153 21A2 25	
280	250		9143 22E2 15	9143 22E3 35			
315	300		9143 23E2 15	9143 23E3 35		9153 23A2 25	
355	350		9143 24E2 15	9143 24E3 35			9143 24A2 38
400	400		9143 25E2 15	9143 25E3 35			9143 25A2 38
450	500		9143 26E2 35				
500	500		9143 27E2 35				9143 27A2 38
560	600		9143 28E2 35				
630	600		9143 29E2 35				
710	700						9113 30E2 05
800	800						9113 31E2 05
900	900						9113 32E2 05
1000	1000						9113 33E2 05



Blindflansch
Flange blind

D [mm]	DN [mm]	PP-St		
		DIN/EN		ANSI
		PN10/16	PN10	150 lbs
25	20	9144 07E1 35		9144 07A2 38
32	25	9144 08E1 35		9144 08A2 38
40	32	9144 09E1 35		9144 09A2 38
50	40	9144 10E1 35		9144 10A2 38
63	50	9144 11E1 35		9144 11A2 38
75	65	9144 12E1 35		9144 12A2 38
90	80	9144 13E1 35		9144 13 A2 38
110	100	9144 14E1 35		9144 14 A2 38
125	100	9144 14E1 35		
140	125	9144 16E1 35		
160	150	9144 17E1 35		9144 17A2 38
180	150	9144 17E1 35		
200	200		9144 19E2 35	9144 19A2 38
225	200		9144 19E2 35	
250	250		9144 21E2 35	9144 21A2 38
280	250		9144 21E2 35	
315	300		9144 23E2 35	9144 23A2 38
355	350		9144 24E2 35	
400	400		9144 25E2 35	



Flachdichtring mit Stahleinlage
Flat gasket with steel-inlay

EPDM		NBR	
Wasser / Water		Gas / Gas	
SDR11	SDR17	SDR11	SDR17
9203 07F1 35		9203 07F2 35	
9203 08F1 35		9203 08F2 35	
9203 09F1 35		9203 09F2 35	
9203 10F1 35		9203 10F2 35	
9203 11F1 35		9203 11F2 35	
9203 12F1 35	9204 12F1 35	9203 12F2 35	9204 12F2 35
9203 13F1 35	9204 13F1 35	9203 13F2 35	9204 13F2 35
9203 14F1 35	9204 14F1 35	9203 14F2 35	9204 14F2 35
9203 15F1 35	9204 15F1 35	9203 15F2 35	9204 15F2 35
9203 16F1 35	9204 16F1 35	9203 16F2 35	9204 16F2 35
9203 17F1 35	9204 17F1 35	9203 17F2 35	9204 17F2 35
9203 18F1 35	9204 18F1 35	9203 18F2 35	9204 18F2 35
9203 19F1 35	9204 19F1 35	9203 19F2 35	9204 19F2 35
9203 20F1 35	9204 20F1 35	9203 20F2 35	9204 20F2 35
9203 21F1 35	9204 21F1 35	9203 21F2 35	9204 21F2 35
9203 22F1 35	9204 22F1 35	9203 22F2 35	9204 22F2 35
9203 23F1 35	9204 23F1 35	9203 23F2 35	9204 23F2 35
9203 24F1 35	9204 24F1 35	9203 24F2 35	9204 24F2 35
9203 25F1 35	9204 25F1 35	9203 25F2 35	9204 25F2 35
9203 26F1 35	9204 26F1 35	9203 26F2 35	9204 26F2 35
9203 27F1 35	9204 27F1 35	9203 27F2 35	9204 27F2 35
9203 28F1 35	9204 28F1 35	9203 28F2 35	9204 28F2 35
9203 29F1 35	9204 29F1 35	9203 29F2 35	9204 29F2 35



2.02.06 Flanschverbindung lang • Flange connection long

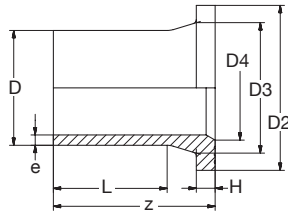

BR PE100 V-Bund für Klappen lang gerillt **SDR11** schwarz

BR PE100 Flange adaptor spigot for valves long grooved **SRD11** black

Art Nr	D	e	D2	D3	D4	H	L	z	KG	VE1	VE2
Art No	[mm]		[mm]							PU1	PU2
2333 12FK 15	75	6,8	122	89	66	16	84	130	0,31	2	24
2333 13FK 15	90	8,2	138	105	82	17	98	145	0,35	2	24
2333 14FK 15	110	10,0	158	125	100	18	102	155	0,54	2	12
2333 16FK 15	140	12,7	188	155	127	25	112	175	0,97	1	8
2333 17FK 15	160	14,6	212	175	153	25	122	185	1,25	1	6
2333 18FK 15	180	16,4	212	180	158	30	161	195	1,35	1	4
2333 19FK 15	200	18,2	268	232	210	32	123	205	2,48	1	3
2333 20FK 15	225	20,5	268	235	210	32	143	215	3,42	1	-
2333 21FK 15	250	22,7	320	285	255	35	150	235	5,26	1	-
2333 22FK 15	280	25,4	320	291	265	35	178	253	5,82	1	-
2333 23FK 15	315	28,6	370	335	309	35	172	257	8,05	1	-
2333 24FK 15	355	32,2	430	373	348	40	195	285	11,30	1	-
2333 25FK 15	400	36,3	482	427	394	46	213	315	14,50	1	-

BR PE100 V-Bund für Klappen lang gerillt **SDR17** schwarz

BR PE100 Flange adaptor spigot for valves long grooved **SRD17** black

Art Nr	D	e	D2	D3	D4	H	L	z	KG	VE1	VE2
Art No	[mm]		[mm]							PU1	PU2
2334 11FK 15	63	3,8	102	75	59	14	78	122	0,11	5	40
2334 12FK 15	75	4,5	122	89	71	16	84	130	0,21	1	18
2334 13FK 15	90	5,4	138	105	85	17	98	145	0,30	1	12
2334 14FK 15	110	6,6	158	125	103,6	18	102	155	0,46	1	12
2334 15FK 15	125	7,4	158	132	114	18	122	170	0,45	1	8
2334 16FK 15	140	8,3	188	155	127	18	119	179	0,69	1	4
2334 17FK 15	160	9,5	212	175	153	18	129	185	0,91	1	6
2334 19FK 15	200	11,9	268	232	210	24	131	205	1,80	1	-
2334 20FK 15	225	13,4	268	235	210	24	151	215	1,77	1	-
2334 21FK 15	250	14,8	320	285	255	25	160	235	2,72	1	-
2334 22FK 15	280	16,6	320	291	265	25	188	253	4,16	1	-
2334 23FK 15	315	18,7	370	335	309	25	182	257	4,24	1	-
2334 24FK 15	355	21,1	430	373	346	30	195	275	7,83	1	-
2334 25FK 15	400	23,7	482	427	394	33	227	315	10,5	1	-

PE100 Sonder-Flanschverbindung lang

Ausführung

Langes Schweißende; für Heizelement-Stumpf-Schweißen und Heizwendel-Muffen-Schweißen geeignet. Gebohrt nach DIN EN 1092-1. Standardmäßig mit Runddicht-ring-EPDM. SDR11/17 und PN10/16.

Mit kunststoffbeschichtetem Sphäroguss- oder Stahlflansch. Ausführung abhängig von der SDR-Klasse und DN/D-Kombination.

Optional

Flansche aus Edelstahl; Flansche aus verzinktem Stahl; flachdichtend ohne Nut und ohne O-Ring; PN25 gebohrt; mit Langloch.

Für Gasleitungen mit glatter Dichtfläche oder NBR-Dichtung lieferbar.

Anwendung

Direkter Anschluss an Armaturen ohne Reduzierung der Nennweite (DN).

Besonderheiten

- Besonders stabil
- Strömungsgünstig
- Reduzierter Totraum
- Integrierte O-Ring-Dichtung
- Klappe der Armatur ist frei beweglich

PE100 Special flange connection long

Type

Long welding end; for the use of butt-welding and electrofusion socket-welding. Drilled according to DIN EN 1092-1. By default inclusive O-Ring-gasket-EPDM. SDR11/17 and PN10/16.

With ductile cast iron or steel backing rings, plastic coated. Type depending on the SDR-Class and on the combination of DN/D.

Optional

Stainless steel backing rings; hot dipped galvanized backing rings; flat sealing surface without flute or O-ring; PN25 drilled; with slotted holes.

Available for gas pipes with flat surface or NBR-Gaskets.

Application

For direct connection to valves according to nominal diameter (DN).

Special features

- Extra stable
- Streamlined
- Reduced dead space
- Integrated O-ring-gasket
- Disc of the valve is free to move

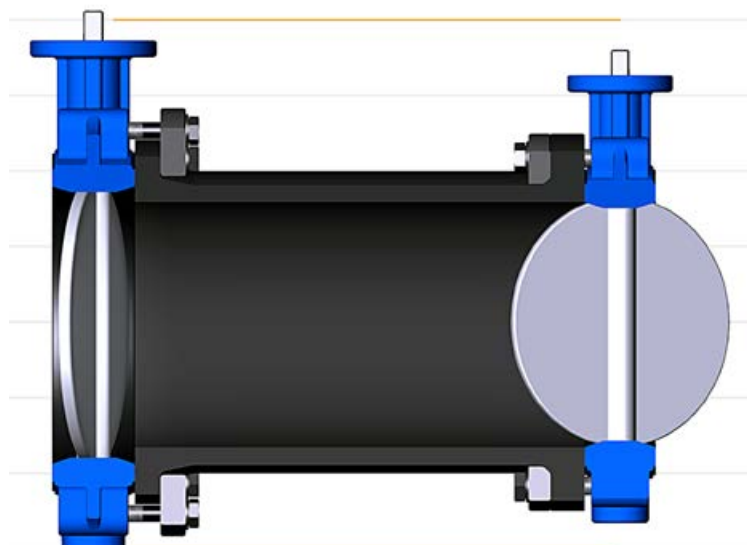
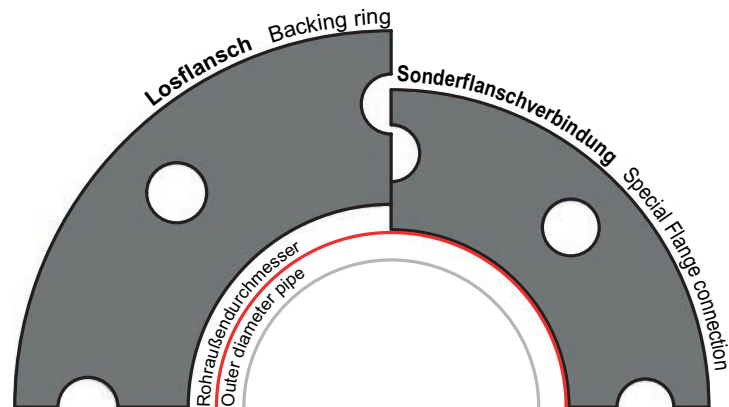

2.02.06 Flanschverbindung lang • Flange connection long

BR PE100 Sonder-Flansch-Verbindung lang **SDR11** schwarz
 BR PE100 Special flange connection long **SDR11** black

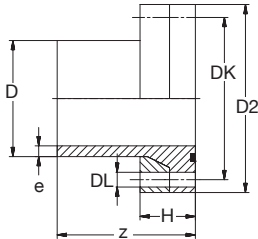

Art Nr	D	PN	DN	e	D2	Z	H	nL	DL	DK			VE1	
Art No	[mm]	gebohrt drilled	[mm]											PU1
9115 13E1 39	90	10/16	65	8,2	185	150	40	4	18	145	M16	3,50	1	
9115 14E1 39	110	10/16	80	10,0	200	155	40	8	18	160	M16	4,50	1	
9115 16E1 39	140	10/16	100	12,7	220	180	45	8	18	180	M16	5,00	1	
9115 17E1 39	160	10/16	125	14,6	250	190	45	8	18	210	M16	6,50	1	
9115 18E1 39	180	10/16	125	16,4	250	195	45	8	18	210	M16	6,50	1	
9115 19E1 39	200	10/16	150	18,2	285	205	50	8	22	240	M20	8,00	1	
9115 21E3 39	250	16	200	22,8	340	245	65	12	22	295	M20	13,0	1	
9115 23E3 39	315	16	250	28,7	405	275	65	12	26	355	M24	20,0	1	
9115 24E3 39	355	16	300	32,3	460	275	65	12	26	410	M24	26,0	1	
9115 25E3 39	400	16	350	36,4	520	330	95	16	26	470	M24	39,0	1	
9115 26E3 39	450	16	400	41,1	580	340	105	16	30	525	M27	52,5	1	
9115 27E3 39	500	16	500	45,4	565	600	92	16	30	525	M27	63,5	1	
9115 28E3 39	560	16	500	51,0	715	395	105	20	33	650	M30	83,0	1	
9115 29E3 39	630	16	500	57,2	715	255	105	20	33	650	M30	95,5	1	
9115 21E2 39	250	10	200	22,8	340	240	60	8	22	295	M20	12,0	1	
9115 23E2 39	315	10	250	28,7	395	270	60	12	22	350	M20	17,0	1	
9115 24E2 39	355	10	300	32,3	445	270	60	12	22	400	M20	22,0	1	
9115 25E2 39	400	10	350	36,4	505	325	90	16	22	460	M20	30,0	1	
9115 26E2 39	450	10	400	41,1	565	335	100	16	26	515	M24	39,0	1	
9115 27E2 39	500	10	400	45,4	565	590	81	16	26	515	M24	50,0	1	
9115 28E2 39	560	10	500	51,0	670	370	100	20	26	620	M24	58,0	1	
9115 29E2 39	630	10	500	57,2	670	255	100	20	26	620	M24	117,0	1	

BR PE100 Sonder-Flansch-Verbindung lang **SDR17** schwarz
 BR PE100 Special flange connection long **SDR17** black

Art Nr	D	PN	DN	e	D2	Z	H	nL	DL	DK			VE1	
Art No	[mm]	gebohrt drilled	[mm]											PU1
9116 13E1 39	90	10/16	65	8,2	185	150	40	4	18	145	M16	3,50	1	
9116 14E1 39	110	10/16	80	10,0	200	155	40	8	18	160	M16	4,50	1	
9116 16E1 39	140	10/16	100	12,7	220	180	45	8	18	180	M16	5,00	1	
9116 17E1 39	160	10/16	125	14,6	250	190	45	8	18	210	M16	6,50	1	
9116 18E1 39	180	10/16	125	16,4	250	195	45	8	18	210	M16	6,50	1	
9116 19E1 39	200	10/16	150	18,2	285	205	50	8	22	240	M20	8,00	1	
9116 21E3 39	250	16	200	22,8	268	350	64	12	22	295	M20	13,0	1	
9116 23E3 39	315	16	250	28,7	315	380	72	12	26	355	M24	20,0	1	
9116 24E3 39	355	16	300	32,3	275	360	74	12	26	410	M24	26,0	1	
9116 25E3 39	400	16	350	36,4	380	430	89	16	26	470	M24	39,0	1	
9116 26E3 39	450	16	400	41,1	560	430	92	16	30	525	M27	52,5	1	
9116 27E3 39	500	16	500	45,4	565	600	92	16	30	525	M27	63,5	1	
9116 28E3 39	560	16	500	51,0	400	440	98	20	33	650	M30	83,0	1	
9116 29E3 39	630	16	500	57,2	610	620	98	20	33	650	M30	95,5	1	
9116 21E2 39	250	10	200	22,8	340	240	60	8	22	295	M20	12,0	1	
9116 23E2 39	315	10	250	28,7	395	270	60	12	22	350	M20	17,0	1	
9116 24E2 39	355	10	300	32,3	445	270	60	12	22	400	M20	22,0	1	
9116 25E2 39	400	10	350	36,4	505	325	90	16	22	460	M20	30,0	1	
9116 26E2 39	450	10	400	41,1	565	335	100	16	26	515	M24	39,0	1	
9116 27E2 39	500	10	400	45,4	565	570	81	16	26	515	M24	50,0	1	
9116 28E2 39	560	10	500	51,0	670	370	100	20	26	620	M24	58,0	1	
9116 29E2 39	630	10	500	57,2	670	255	100	20	26	620	M24	117,0	1	

2.02.07 Kugelhähne lang • Ball valves long

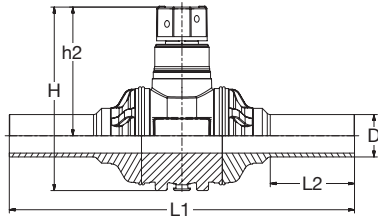

BR PE100 Kugelhahn Abwasser PN10 lang Anschlüsse **SDR11** schwarz
BR PE100 Ball valve sewage water PN10 long connectors **SDR11** black

Art Nr Art No	D [mm]	L1	L2	H1	h2	KG	VE1 PU1
2913 08S0 35	32	322	58	190	139	1,0	1
2913 09S0 35	40	410	100	203	145	1,2	1
2913 10S0 35	50	415	100	217	152	1,6	1
2913 11S0 35	63	435	100	252	176	2,5	1
2913 13S0 35	90	550	110	299	200	5,0	1
2913 14S0 35	110	595	115	320	210	6,6	1
2913 15S0 35	125	610	125	320	210	7,2	1
2913 17S0 35	160	690	120	403	254	13,4	1
2913 18S0 35	180	690	120	403	254	14,5	1

Keine Lagerware • Not a stock item.

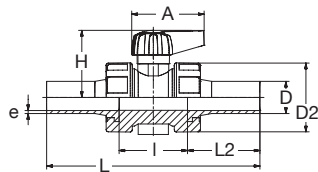

BR PE100-PVC-U Kugelhahn lang Anschlüsse **SDR11** schwarz
BR PE100-PVC-U Ball valve long connectors **SDR11** black

Art Nr Art No	D [mm]	D2	e	L	L2	I	H	A	KG	VE1 PU1
EPDM										
2913 07R1 25	25	59	2,3	243	60	65	57	82	0,2	1
2913 08R1 25	32	71	3,0	261	60	71	65	82	0,3	1
2913 09R1 25	40	86	3,7	278	66	86	84	92	0,5	1
2913 10R1 25	50	100	4,6	320	80	90	90	92	0,7	1
2913 11R1 25	63	126	5,8	349	85	101	115	143	1,1	1
FKM (FPM)*										
2913 07R3 25	25	59	2,3	243	60	65	57	82	0,2	1
2913 08R3 25	32	71	3,0	261	60	71	65	82	0,3	1
2913 09R3 25	40	86	3,7	278	66	86	84	92	0,5	1
2913 10R3 25	50	100	4,6	320	80	90	90	92	0,7	1
2913 11R3 25	63	126	5,8	349	85	101	115	143	1,1	1

* Keine Lagerware • Not a stock item.

2.03 Formteile KURZ • Fittings SHORT

PE100 Formteile mit kurzen Schweißenden SDR11/17 schwarz

gespritzt, für die Heizelement-Stumpf-Schweißung

Werkstoff

PE100, schwarz. Das Material entspricht den Anforderungen der aktuellen KTW-Leitlinie des Umweltbundesamtes (UBA).

Geometrische Eigenschaften

Abmessungen und Toleranzen entsprechend EN 1555-3 und EN 12201-3, sowie ISO 4427-3 und ISO 4437-3.

Toleranzen bei den Z-Maßangaben sind abhängig von der Dimension. Bis d/D 160 = +/- 3 mm. Ab d/D 180 = +/- 10 mm.

Ausführung

Geeignet für Heizelement-Stumpf-Schweißung nach DVS Richtlinie 2207. Schweiß-Geräte und Schweiß-Werkzeuge sollten der DVS Richtlinie 2208 entsprechen.

Lieferung

Abgabe erfolgt nur in kompletten Verpackungseinheiten (VE's).

PE100 Fittings with short spigots SDR11/17 black injection moulded, for butt-welding

Material

PE100, black. The material complies with the requirements of the KTW guideline of the German Federal Environmental Agency (UBA).

Geometric Properties

Dimensions and tolerances of the spigot ends according to EN 1555-3 and EN 12201-3, plus ISO 4427-3 and ISO 4437-3.

Tolerances of z-sizes depend on the dimension. Up to d/D 160 = +/- 3 mm and from d/D 180 = +/- 10 mm.

Type

Suitable for butt-welding according to DVS technical code 2207. Welding equipment according to DVS technical code 2208.

Delivery

Supply only in complete packing units (PU's).

2.03.01 Bögen, Winkel kurz • Bends, Elbows short

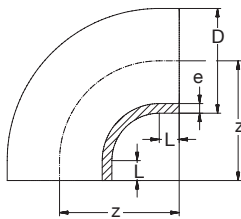

BR PE100 Bogen 90° kurz **SDR11** schwarz

BR PE100 Bend 90° short **SDR11** black

Art Nr	D	e	L	z	KG	VE1	VE2
Art No	[mm]		[mm]			PU1	PU2
2425 0690 35	20	1,8	3	27	0,005	10	-
2425 0790 35	25	2,3	5	32	0,010	10	140
2425 0890 35	32	3,0	6	37	0,020	10	80
2425 0990 35	40	3,7	8	44	0,030	10	40
2425 1090 35	50	4,6	10	51	0,070	5	40
2425 1190 35	63	5,8	12	66	0,14	5	50
2425 1290 35	75	6,8	14	87	0,25	2	26
2425 1390 35	90	8,2	15	100	0,35	2	16
2425 1490 35	110	10,0	15	118	0,69	2	8
2425 1590 35	125	11,4	15	138	1,05	1	6
2425 1690 35	140	12,7	20	155	1,45	1	4
2425 1790 35	160	14,6	25	178	1,98	1	3
2425 1890 35	180	16,4	25	195	2,83	1	2
2425 1990 35	200	18,2	20	210	3,91	1	-
2425 2090 35	225	20,5	25	236	5,40	1	-
2425 2190 35	250	22,7	30	279	7,26	1	-
2425 2290 35	280	25,4	40	316	10,5	1	-
2425 2390 35	315	28,6	40	352	14,6	1	-

BR PE100 Bogen 90° kurz **SDR17** schwarz

BR PE100 Bend 90° short **SDR17** black

Art Nr	D	e	L	z	KG	VE1	VE2
Art No	[mm]		[mm]			PU1	PU2
2426 1090 35	50	3,0	10	51	0,049	5	40
2426 1190 35	63	3,8	12	66	0,080	5	50
2426 1290 35	75	4,5	14	87	0,18	2	26
2426 1390 35	90	5,4	15	100	0,29	2	16
2426 1490 35	110	6,6	15	118	0,49	2	8
2426 1590 35	125	7,4	15	138	0,79	1	6
2426 1690 35	140	8,3	20	155	1,07	1	4
2426 1790 35	160	9,5	25	178	1,54	1	3
2426 1890 35	180	10,7	25	195	2,29	1	2
2426 1990 35	200	11,9	20	210	3,10	1	-
2426 2090 35	225	13,4	25	236	4,19	1	-
2426 2190 35	250	14,8	30	279	4,73	1	-
2426 2290 35	280	16,6	40	316	6,79	1	-
2426 2390 35	315	18,7	40	352	9,49	1	-

2.03.01 Bögen, Winkel kurz • Bends, Elbows short

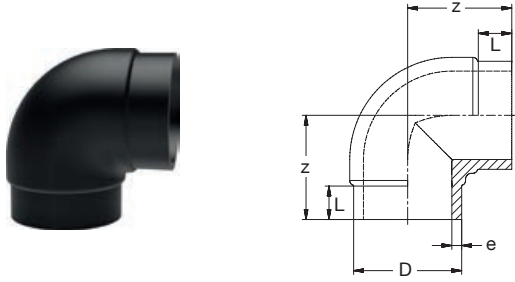

BR PE100 Winkel 90° kurz **SDR11** schwarz
BR PE100 Elbow 90° short **SDR11** black

Art Nr Art No	D [mm]	e	L	z	KG	VE1 PU1	VE2 PU2
2415 0790 15	25	2,3	12	36	0,014	5	180
2415 0890 15	32	3,0	14	39	0,026	5	130
2415 0990 15	40	3,7	16	46	0,046	5	75
2415 1090 15	50	4,6	18	47	0,090	5	50
2415 1190 15	63	5,8	22	63	0,18	5	45
2415 1290 15	75	6,8	25	70	0,24	2	30
2415 1390 15	90	8,2	28	91	0,40	2	16
2415 1490 15	110	10,0	34	101	0,78	2	10
2415 1590 15	125	11,4	42	120	1,25	2	8
2415 1690 15	140	12,7	45	125	1,60	1	4
2415 1790 15	160	14,6	50	146	2,36	1	2
2415 1890 15	180	16,4	55	171	3,29	1	2
2415 1990 15	200	18,2	60	188	4,38	1	-
2415 2090 15	225	20,5	65	205	6,17	1	-
2415 2190 15	250	22,7	70	222	7,80	1	-
2415 2290 15	280	25,4	80	259	10,7	1	-
2415 2390 15	315	28,6	90	295	14,9	1	-

BR PE100 Winkel 90° kurz **SDR17** schwarz
BR PE100 Elbow 90° short **SDR17** black

Art Nr Art No	D [mm]	e	L	z	KG	VE1 PU1	VE2 PU2
2416 1290 15	75	4,5	25	70	0,22	2	30
2416 1390 15	90	5,4	28	91	0,32	2	16
2416 1490 15	110	6,6	34	101	0,60	2	8
2416 1590 15	125	7,4	42	120	0,89	1	8
2416 1690 15	140	8,3	45	125	1,25	1	4
2416 1790 15	160	9,5	50	146	1,77	1	3
2416 1890 15	180	10,7	55	171	2,49	1	2
2416 1990 15	200	11,9	60	188	3,24	1	-
2416 2090 15	225	13,4	65	205	4,39	1	-
2416 2190 15	250	14,8	70	222	5,96	1	-
2416 2290 15	280	16,6	80	259	8,24	1	-
2416 2390 15	315	18,7	90	295	11,3	1	-

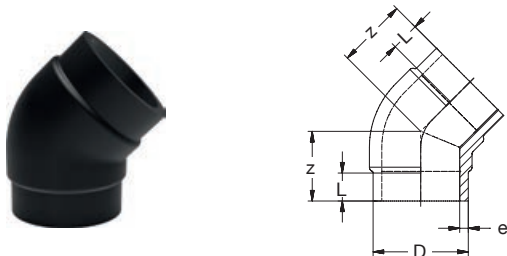

BR PE100 Winkel 45 kurz **SDR11** schwarz
BR PE100 Elbow 45 short **SDR11** black

Art Nr Art No	D [mm]	e	L	z	KG	VE1 PU1	VE2 PU2
2415 0745 15	25	2,3	12	21	0,01	10	300
2415 0845 15	32	3,0	14	30	0,02	5	300
2415 0945 15	40	3,7	16	40	0,05	1	150
2415 1045 15	50	4,6	18	42	0,08	1	90
2415 1145 15	63	5,8	22	49	0,14	1	60
2415 1245 15	75	6,8	25	68	0,17	1	45
2415 1345 15	90	8,2	28	66	0,35	1	20
2415 1445 15	110	10,0	34	79	0,54	1	12
2415 1645 15	140	12,7	45	97	1,30	1	5
2415 1745 15	160	14,6	50	108	1,85	1	2
2415 1845 15	180	16,4	55	112	2,56	1	-
2415 1945 15	200	18,2	60	125	3,33	1	-
2415 2045 15	225	20,5	65	131	5,03	1	-
2415 2145 15	250	22,7	70	166	6,44	1	-
2415 2245 15	280	25,4	80	183	8,84	1	-
2415 2345 15	315	28,6	90	200	11,7	1	-

BR PE100 Winkel 45 kurz **SDR17** schwarz
BR PE100 Elbow 45 short **SDR17** black

Art Nr Art No	D [mm]	e	L	z	KG	VE1 PU1	VE2 PU2
2416 1245 15	75	4,5	25	68	0,13	1	-
2416 1345 15	90	5,4	28	66	0,27	1	20
2416 1445 15	110	6,6	34	79	0,43	1	12
2416 1645 15	140	8,3	45	97	0,87	1	5
2416 1745 15	160	9,5	50	108	1,31	1	2
2416 1845 15	180	10,7	55	112	1,87	1	-
2416 1945 15	200	11,9	60	125	2,44	1	-
2416 2045 15	225	13,4	65	131	3,37	1	-
2416 2145 15	250	14,8	70	166	4,62	1	-
2416 2245 15	280	16,6	80	183	6,59	1	-
2416 2345 15	315	18,7	90	200	9,06	1	-

2.03.02 T-Stücke kurz • Tee's short

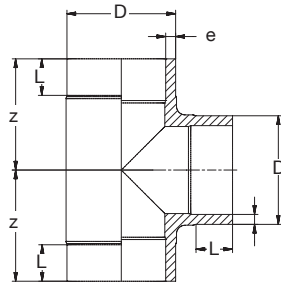

BR PE100 T-Stück 90° kurz **SDR11** schwarz
BR PE100 Tee 90° short **SDR11** black

Art Nr	D	e	L	z	KG	VE1	VE2
Art No	[mm]	[mm]	[mm]	[mm]		PU1	PU2
2515 0790 15	25	2,3	12	33	0,025	5	150
2515 0890 15	32	3,0	14	37	0,040	5	80
2515 0990 15	40	3,7	16	42	0,070	1	100
2515 1090 15	50	4,6	18	51	0,14	1	60
2515 1190 15	63	5,8	22	67	0,22	1	50
2515 1290 15	75	6,8	25	75	0,36	1	20
2515 1390 15	90	8,2	28	98	0,67	1	10
2515 1490 15	110	10,0	34	109	1,04	1	6
2515 1590 15	125	11,4	42	128	1,37	1	6
2515 1690 15	140	12,7	45	137	1,98	1	2
2515 1790 15	160	14,6	50	152	3,07	1	2
2515 1890 15	180	16,4	55	172	4,29	1	-
2515 1990 15	200	18,2	60	190	5,65	1	-
2515 2090 15	225	20,5	65	215	8,58	1	-
2515 2190 15	250	22,7	70	222	9,40	1	-
2515 2290 15	280	25,4	80	259	17,7	1	-
2515 2390 15	315	28,6	90	295	22,9	1	-
2515 2490 15	355	32,2	100	318	27,0	1	-

BR PE100 T-Stück 90° kurz **SDR17** schwarz
BR PE100 Tee 90° short **SDR17** black

Art Nr	D	e	L	z	KG	VE1	VE2
Art No	[mm]	[mm]	[mm]	[mm]		PU1	PU2
2516 1090 35	50	3,0	18	51	0,090	1	60
2516 1190 35	63	3,8	22	67	0,17	1	50
2516 1290 15	75	4,5	25	75	0,26	1	20
2516 1390 35	90	5,4	28	98	0,50	1	10
2516 1490 15	110	6,6	34	109	0,88	1	6
2516 1590 15	125	7,4	42	128	1,02	1	6
2516 1690 15	140	8,3	45	137	1,63	1	2
2516 1790 15	160	9,5	50	152	2,58	1	2
2516 1890 15	180	10,7	55	172	3,06	1	-
2516 1990 15	200	11,9	60	190	4,10	1	-
2516 2090 15	225	13,4	65	215	6,19	1	-
2516 2190 15	250	14,8	70	222	6,72	1	-
2516 2290 35	280	16,6	80	259	12,0	1	-
2516 2390 35	315	18,7	90	295	17,5	1	-

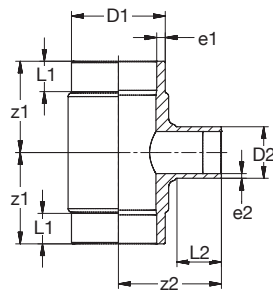

BR PE100 T-Stück 90° red kurz **SDR11** schwarz
BR PE100 Tee 90° red short **SDR11** black

Art Nr	D1-D2	e1	e2	L1	L2	z1	z2	KG	VE1	VE2
Art No	[mm]	[mm]	[mm]	[mm]	[mm]	[mm]	[mm]		PU1	PU2
2525 1108 15	63-32	5,8	3,0	22	15	67	69	0,19	2	6
2525 1411 15	110-63	10,0	5,8	48	32	120	105	0,90	1	6
2525 1413 15	110-90	10,0	8,2	48	38	120	115	0,97	1	6
2525 1714 15	160-110	14,6	10,0	56	38	160	145	2,81	1	2
2525 1917 35	200-160	18,2	14,6	98	53	194	178	5,20	1	-
2525 2014 15	225-110	20,5	10,0	89	88	220	264	7,07	1	-
2525 2015 15	225-125	20,5	11,4	79	32	185	205	6,39	1	-
2525 2017 15	225-160	20,5	14,6	89	60	235	200	7,21	1	-

BR PE100 T-Stück 90° red kurz **SDR17** schwarz
BR PE100 Tee 90° red short **SDR17** black

Art Nr	D1-D2	e1	e2	L1	L2	z1	z2	KG	VE1	VE2
Art No	[mm]	[mm]	[mm]	[mm]	[mm]	[mm]	[mm]		PU1	PU2
2526 1411 15	110-63	6,6	5,8*	48	32	120	105	0,73	1	6
2526 1413 15	110-90	6,6	5,4	48	38	120	115	0,75	1	6
2526 1714 15	160-110	9,5	6,6	56	38	160	145	2,13	1	2
2526 1917 35	200-160	11,9	9,5	134	114	275	265	3,70	1	-
2526 2014 15	225-110	13,4	6,6	89	88	220	264	5,52	1	-
2526 2015 15	225-125	13,4	7,4	79	32	185	205	5,54	1	-
2526 2017 15	225-160	13,4	9,5	89	60	235	200	5,51	1	-

* SDR 11

2.03.03 Reduktionen kurz • Reducers short

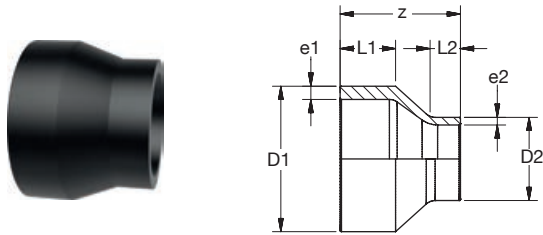

BR PE 100 Reduktion kurz **SDR11** schwarz

BR PE 100 Reducer short **SDR11** black

Art Nr	D1-D2	e1	e2	L1	L2	z	KG	VE1	VE2
Art No	[mm]	[mm]		[mm]				PU1	PU2
2325 0706 35	25-20	2,3	1,9	12	12	37	0,010	10	120
2325 0806 35	32-20	3,0	1,9	12	12	43	0,010	10	120
2325 0807 15	32-25	3,0	2,3	16	14	38	0,010	1	370
2325 0906 35	40-20	3,7	1,9	12	12	50	0,020	10	120
2325 0907 15	40-25	3,7	2,3	19	14	47	0,016	1	120
2325 0908 15	40-32	3,7	3,0	19	15	39	0,016	10	60
2325 1007 15	50-25	4,6	2,3	19	17	53	0,027	10	250
2325 1008 15	50-32	4,6	3,0	18	14	44	0,029	10	200
2325 1009 15	50-40	4,6	3,7	20	19	46	0,029	10	200
2325 1108 15	63-32	5,8	3,0	23	22	63	0,052	1	120
2325 1109 15	63-40	5,8	3,7	24	18	58	0,052	1	120
2325 1110 15	63-50	5,8	4,6	25	20	54	0,059	1	120
2325 1209 35	75-40	6,8	3,7	29	22	70	0,074	2	52
2325 1210 35	75-50	6,8	4,6	28	23	71	0,081	2	18
2325 1211 35	75-63	6,8	5,8	29	31	70	0,10	2	20
2325 1310 15	90-50	8,2	4,6	26	22	73	0,12	1	16
2325 1311 15	90-63	8,2	5,8	29	24	71	0,13	1	60
2325 1312 35	90-75	8,2	6,8	33	33	80	0,16	1	60
2325 1410 35	110-50	10,0	4,6	33	29	90	0,21	2	30
2325 1411 15	110-63	10,0	5,8	42	23	91	0,26	1	30
2325 1412 35	110-75	10,0	6,8	34	35	90	0,25	2	8
2325 1413 15	110-90	10,0	8,2	40	28	88	0,27	1	24
2325 1511 35	125-63	11,4	5,8	40	34	100	0,30	2	30
2325 1512 15	125-75	11,4	6,8	48	31	103	0,32	1	36
2325 1513 15	125-90	11,4	8,2	38	30	100	0,39	1	24
2325 1514 35	125-110	11,4	10,0	40	48	100	0,40	2	16
2325 1612 35	140-75	12,7	6,8	49	37	110	0,46	2	8
2325 1613 35	140-90	12,7	8,2	45	28	126	0,44	2	8
2325 1614 35	140-110	12,7	10,0	45	34	126	0,50	2	8
2325 1615 35	140-125	12,7	11,4	45	42	128	0,55	2	8
2325 1713 35	160-90	14,6	8,2	53	37	160	0,67	2	8
2325 1714 15	160-110	14,6	10,0	50	39	125	0,74	1	8
2325 1715 35	160-125	14,6	11,4	54	45	120	0,70	2	8
2325 1716 15	160-140	14,6	12,7	44	43	98	0,81	1	8
2325 1813 35	180-90	16,4	8,2	59	37	130	0,99	1	8
2325 1814 35	180-110	16,4	10,0	60	40	130	0,99	1	8
2325 1815 15	180-125	16,4	11,4	62	42	152	1,05	1	8
2325 1816 35	180-140	16,4	12,7	59	46	130	0,97	1	8
2325 1817 15	180-160	16,4	14,6	60	55	131	1,21	1	12
2325 1915 15	200-125	18,2	11,6	60	45	160	1,35	1	8
2325 1916 35	200-140	18,2	12,7	60	48	140	1,26	1	8
2325 1917 15	200-160	18,2	14,6	60	54	140	1,52	1	6
2325 1920 35	200-180	18,2	16,4	60	61	140	1,42	1	10
2325 2014 15	225-110	20,5	10,0	68	37	190	1,81	1	2
2325 2016 35	225-140	20,5	12,7	65	57	160	1,80	1	5
2325 2017 15	225-160	20,5	14,8	65	50	190	2,03	1	2
2325 2018 15	225-180	20,5	16,4	65	55	190	2,05	1	2
2325 2019 35	225-200	20,5	18,2	71	71	160	1,90	1	3

Art Nr	D1-D2	e1	e2	L1	L2	z	KG	VE1	VE2
Art No	[mm]	[mm]		[mm]				PU1	PU2
2325 2117 15	250-160	22,8	14,6	70	50	210	2,65	1	2
2325 2118 15	250-180	22,8	16,4	70	55	200	2,73	1	2
2325 2119 15	250-200	22,8	18,2	70	60	200	2,96	1	2
2325 2120 15	250-225	22,8	20,5	70	65	200	3,03	1	-
2325 2218 15	280-180	25,4	16,4	70	54	213	3,64	1	-
2325 2219 15	280-200	25,4	18,2	80	60	220	3,81	1	-
2325 2220 15	280-225	25,4	20,5	80	65	220	3,90	1	-
2325 2221 15	280-250	25,4	22,7	80	70	220	4,29	1	-
2325 2319 35	315-200	28,6	18,2	95	85	230	5,10	1	-
2325 2320 15	315-225	28,6	20,5	90	64	245	5,19	1	-
2325 2321 15	315-250	28,6	22,7	90	70	245	5,56	1	-
2325 2322 15	315-280	28,6	25,5	90	80	245	5,77	1	-
2325 2420 35	355-225	32,2	20,5	57	40	140	4,70	1	-
2325 2421 15	355-250	32,2	22,7	95	70	265	7,19	1	-
2325 2422 15	355-280	32,2	25,4	95	80	270	7,50	1	-
2325 2423 15	355-315	32,2	28,6	95	90	270	8,03	1	-
2325 2522 15	400-280	36,6	25,4	105	80	295	9,77	1	-
2325 2523 15	400-315	36,6	28,6	105	90	300	10,5	1	-
2325 2524 15	400-355	36,6	32,2	105	95	295	10,9	1	-
2325 2623 35	450-315	40,9	28,6	56	40	168	7,82	1	-
2325 2624 35	450-355	40,9	32,2	52	43	143	8,45	1	-
2325 2625 35	450-400	40,9	36,4	60	57	143	7,60	1	-
2325 2724 35	500-355	45,4	32,2	57	38	161	9,30	1	-
2325 2725 35	500-400	45,4	36,3	57	58	160	9,60	1	-
2325 2726 35	500-450	45,4	41,0	60	40	120	9,80	1	-
2325 2825 35	560-400	50,8	36,6	72	37	196	15,9	1	-
2325 2826 35	560-450	50,8	40,9	79	60	196	14,7	1	-
2325 2827 35	560-500	50,8	45,5	77	75	177	14,8	1	-
2325 2926 35	630-450	57,2	40,9	60	40	200	21,3	1	-
2325 2927 35	630-500	57,2	45,5	67	40	150	21,1	1	-
2325 2928 35	630-560	57,2	51,0	64	40	130	19,2	1	-

2.03.03 Reduktionen kurz • Reducers short

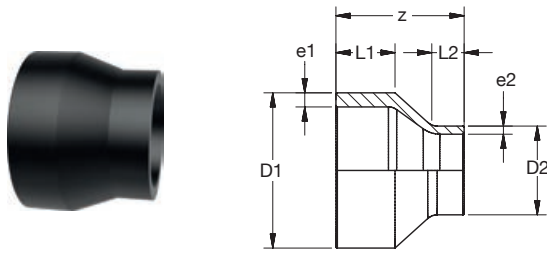

BR PE 100 Reduktion kurz **SDR17** schwarz

BR PE 100 Reducer short **SDR17** black

Art Nr	D1-D2	e1	e2	L1	L2	z	kg	VE1	VE2
Art No	[mm]	[mm]		[mm]				PU1	PU2
2326 1009 35	50-40	3,0	2,4	20	19	46	0,022	10	280
2326 1108 35	63-32	3,8	1,9	23	22	63	0,033	1	120
2326 1109 35	63-40	3,8	2,4	24	18	58	0,038	1	120
2326 1110 35	63-50	3,8	3,0	25	20	54	0,040	1	120
2326 1209 35	75-40	4,5	2,4	29	22	70	0,051	2	52
2326 1210 35	75-50	4,5	3,0	28	23	71	0,055	2	18
2326 1211 35	75-63	4,5	3,8	29	31	70	0,062	2	20
2326 1310 15	90-50	5,4	4,6*	26	22	73	0,10	1	16
2326 1311 15	90-63	5,4	5,8*	29	24	71	0,12	1	60
2326 1312 35	90-75	5,4	4,5	33	33	80	0,10	1	60
2326 1410 35	110-50	6,6	5,4	33	29	90	0,21	2	30
2326 1411 15	110-63	6,6	3,8	42	23	91	0,20	1	30
2326 1412 15	110-75	6,6	4,5	34	35	90	0,16	2	8
2326 1413 15	110-90	6,6	5,4	40	28	88	0,18	1	24
2326 1511 35	125-63	7,4	6,6	40	34	100	0,20	2	8
2326 1512 15	125-75	7,4	4,5	48	31	103	0,27	1	36
2316 1513 15	125-90	7,4	5,4	38	30	100	0,27	1	8
2326 1514 35	125-110	7,4	6,6	40	48	100	0,27	2	16
2326 1612 35	140-75	8,3	4,5	49	37	110	0,29	2	8
2326 1613 35	140-90	8,3	5,4	45	28	126	0,30	2	8
2326 1614 35	140-110	8,3	6,6	45	34	126	0,33	2	8
2326 1615 35	140-125	8,3	7,4	45	42	128	0,38	2	8
2326 1713 35	160-90	9,5	5,4	53	37	160	0,50	2	8
2326 1714 15	160-110	9,5	6,6	50	39	125	0,53	1	8
2326 1715 35	160-125	9,5	7,4	54	45	120	0,48	2	8
2326 1716 15	160-140	9,5	8,3	44	43	98	0,61	1	8
2326 1813 35	180-90	10,7	5,4	59	37	130	0,69	1	8
2326 1814 35	180-110	10,7	6,6	60	40	130	0,77	1	8
2326 1815 15	180-125	10,7	7,4	62	42	152	0,72	1	8
2326 1816 35	180-140	10,7	8,3	59	46	130	0,65	1	8
2326 1817 15	180-160	10,7	9,5	60	55	131	1,03	1	12
2326 1915 15	200-125	11,9	7,4	60	45	160	1,30	1	8
2326 1916 35	200-140	11,9	8,3	60	48	140	0,86	1	8
2326 1917 15	200-160	11,9	9,5	60	54	140	1,01	1	8
2326 1918 35	200-180	11,9	10,7	60	61	140	0,97	1	10
2326 2014 15	225-110	13,4	6,6	68	37	190	1,55	1	3
2326 2016 35	225-140	13,4	8,3	65	57	160	1,80	1	5
2326 2017 15	225-160	13,4	9,5	65	50	190	1,40	1	5
2326 2018 15	225-180	13,4	10,7	65	55	190	1,26	1	3
2326 2019 35	225-200	13,4	11,9	71	71	160	1,42	1	3
2326 2117 15	250-160	14,8	9,5	70	50	210	2,32	1	2
2326 2118 15	250-180	14,8	10,7	70	55	200	2,37	1	2
2326 2119 15	250-200	14,8	11,9	70	60	200	2,55	1	2
2326 2120 15	250-225	14,8	13,4	70	65	200	2,54	1	-
2326 2218 15	280-180	16,6	10,7	70	54	213	3,26	1	-
2326 2219 15	280-200	16,6	11,9	80	60	220	3,45	1	-
2326 2220 15	280-225	16,6	13,4	80	65	220	3,49	1	-
2326 2221 15	280-250	16,6	14,8	80	70	220	3,53	1	-

Art Nr	D1-D2	e1	e2	L1	L2	z	kg	VE1	VE2
Art No	[mm]	[mm]		[mm]				PU1	PU2
2326 2319 35	315-200	18,7	11,9	95	85	230	3,40	1	-
2326 2320 15	315-225	18,7	13,4	90	64	245	4,88	1	-
2326 2321 15	315-250	18,7	14,8	90	70	245	4,79	1	-
2326 2322 15	315-280	18,7	16,6	90	80	245	4,82	1	-
2326 2420 35	355-225	21,1	13,4	57	40	140	6,10	1	-
2326 2421 15	355-250	21,1	14,8	95	70	265	6,16	1	-
2326 2422 15	355-280	21,1	16,6	95	80	270	6,56	1	-
2326 2423 15	355-315	21,1	18,7	95	90	270	6,71	1	-
2326 2522 15	400-280	23,7	16,6	105	80	295	8,67	1	-
2326 2523 15	400-315	23,7	18,7	105	90	300	8,93	1	-
2326 2524 15	400-355	23,7	16,6	105	95	295	9,06	1	-
2326 2623 35	450-315	26,7	18,7	56	40	168	6,42	1	-
2326 2624 35	450-355	26,7	21,1	52	43	143	5,48	1	-
2326 2625 35	450-400	26,7	23,7	60	57	143	5,80	1	-
2326 2724 35	500-355	29,7	21,1	57	38	161	7,60	1	-
2326 2725 35	500-400	29,7	23,7	57	58	160	6,60	1	-
2326 2726 35	500-450	29,7	26,7	60	40	120	6,62	1	-
2326 2825 35	560-400	33,2	23,7	72	37	196	10,5	1	-
2326 2826 35	560-450	33,2	26,7	79	60	196	10,8	1	-
2326 2827 35	560-500	33,2	29,7	77	75	177	11,4	1	-
2326 2926 35	630-450	37,4	26,7	60	40	200	16,6	1	-
2326 2927 35	630-500	37,4	29,7	67	40	150	13,6	1	-
2326 2928 35	630-560	37,4	33,2	64	40	130	12,5	1	-
2326 3028 35	710-560	42,1	33,2	67	49	195	15,7	1	-
2326 3029 35	710-630	42,1	37,4	60	46	144	15,3	1	-
2326 3130 35	800-710	47,4	42,1	68	52	167	25,1	1	-
2326 3231 35	900-800	53,3	47,4	68	43	156	25,1	1	-
2326 3332 35	1000-900	59,3	53,3	67	75	190	34,5	1	-

2.03.04 Übergänge kurz • Transitions short

PE100 Übergang kurz SDR11

Betriebsdruck 0,8 MPa (für Wasser bei 20°C)

PE100 Transition short SDR11

Operating pressure 0.8 MPa (for water at 20°C)

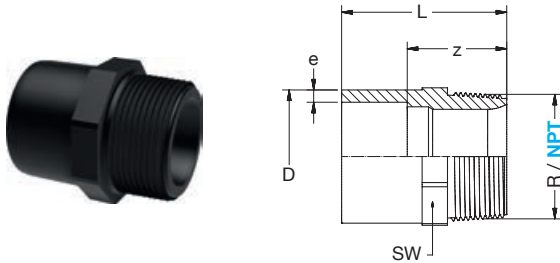

BR PE100 Übergang kurz AG-keg SDR11 schwarz

BR PE100 Transition short male-thread-con SDR11 black

Art Nr	D x R	e	L	z	SW	KG	VE1	VE2
Art No	[mm x Inch]	[mm]					PU1	PU2
2615 0773 15	25 x 1/2	2,3	45	29	26	0,012	1	130
2615 0775 15	25 x 3/4	2,3	47	31	26	0,013	1	100
2615 0875 15	32 x 3/4	3,0	47	31	34	0,017	1	100
2615 0876 15	32 x 1	3,0	48	35	34	0,021	1	50
2615 0976 15	40 x 1	3,7	58	36	44	0,032	1	60
2615 0977 15	40 x 1 1/4	3,7	59	39	44	0,034	1	100
2615 1077 15	50 x 1 1/4	4,6	63	43	49	0,050	1	60
2615 1078 15	50 x 1 1/2	4,6	65	46	49	0,056	1	60
2615 1178 15	63 x 1 1/2	5,8	72	52	65	0,082	1	60
2615 1180 15	63 x 2	5,8	76	52	65	0,090	1	60

BR PE100 Übergang kurz AG-NPT SDR11 schwarz

BR PE100 Transition short male-thread-NPT SDR11 black

Art Nr	D x NPT	e	L	z	SW	KG	VE1	VE2
Art No	[mm x Inch]	[mm]					PU1	PU2
2615 0876 U5	32 x 1	3,0	48	35	34	0,021	1	50
2615 0977 U5	40 x 1 1/4	3,7	59	39	44	0,034	1	100
2615 1078 U5	50 x 1 1/2	4,6	65	46	49	0,056	1	60
2615 1180 U5	63 x 2	5,8	76	52	65	0,090	1	60

2.03.05 Flanschverbindung kurz • Flange connection short

Vorschweißbund (V-Bund) kurz in gerillter Ausführung für den Einsatz von Flachdichtungen.

Weitere Informationen zu Flanschen und Dichtungen finden Sie unter Zubehör.

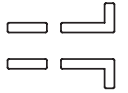

Flange adaptor spigot short grooved for the use of flat-gaskets.

More information about flanges and gaskets see Accessories.

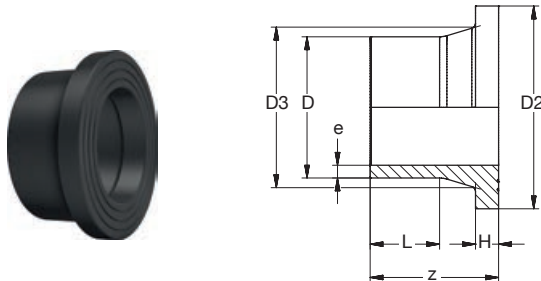

BR PE100 V-Bund kurz gerillt **SDR11** schwarz

BR PE100 Flange adaptor spigot short rilled **SRD11** black

Art Nr	D	e	D2	D3	H	L	z	KG	VE1	VE2
Art No	[mm]		[mm]						PU1	PU2
2335 07F0 15	25	2,3	58	33	9	18	35	0,031	10	170
2335 08F0 15	32	3,0	68	40	10	18	40	0,043	10	140
2335 09F0 15	40	3,7	78	50	11	18	40	0,064	10	150
2335 10F0 15	50	4,6	88	61	12	23	60	0,095	10	90
2335 11F0 15	63	5,8	102	75	14	31	75	0,16	2	12
2335 12F0 15	75	6,8	122	89	16	34	80	0,25	2	36
2335 13F0 15	90	8,2	138	105	17	43	90	0,35	2	24
2335 14F0 15	110	10,0	158	125	18	47	100	0,54	2	12
2335 15F0 15	125	11,4	158	132	25	55	110	0,66	2	10
2335 16F0 15	140	12,7	188	155	25	53	116	0,97	2	8
2335 17F0 15	160	14,6	212	175	25	64	127	1,25	2	6
2335 18F0 15	180	16,4	212	180	30	108	138	1,46	2	4
2335 19F0 15	200	18,2	268	232	32	63	145	2,48	1	-
2335 20F0 15	225	20,5	268	235	32	78	150	2,52	1	-
2335 21F0 15	250	22,7	320	285	35	73	158	3,86	1	-
2335 22F0 15	280	25,4	320	291	35	105	180	4,29	1	-
2335 23F0 15	315	28,6	370	335	35	105	190	6,00	1	-
2335 24F0 15	355	32,2	430	373	40	120	210	8,75	1	-
2335 25F0 15	400	36,3	482	427	46	124	225	12,0	1	-
2335 26F0 15	450	40,9	585	514	60	170	300	13,8	1	-
2335 27F0 15	500	45,4	585	530	60	175	295	24,0	1	-
2335 28F0 35	560	50,8	685	615	60	10	130	18,5	1	-
2335 29F0 15	630	57,2	685	642	60	195	305	21,6	1	-
2335 30F0 35	710	64,5							1	-
2335 31F0 35	800	72,6							1	-
2335 32F0 35	900	81,7							1	-
2335 33F0 35	1000	90,8							1	-

BR PE100 V-Bund kurz gerillt **SDR17** schwarz

BR PE100 Flange adaptor spigot short rilled **SRD17** black

Art Nr	D	e	D2	D3	H	L	z	KG	VE1	VE2
Art No	[mm]		[mm]						PU1	PU2
2336 10F0 35	50	2,9	88	61	12	23	60	0,070	10	90
2336 11F0 35	63	3,8	102	75	14	31	75	0,11	2	12
2336 12F0 15	75	4,5	122	89	16	34	80	0,21	2	36
2336 13F0 15	90	5,4	138	105	17	43	90	0,30	2	24
2336 14F0 15	110	6,6	158	125	18	47	100	0,46	2	12
2336 15F0 15	125	7,4	158	132	18	62	110	0,45	2	10
2336 16F0 15	140	8,3	188	155	18	67	120	0,69	2	8
2336 17F0 15	160	9,5	212	175	18	74	127	0,91	2	6
2336 18F0 15	180	10,7	212	180	20	108	138	0,98	2	4
2336 19F0 15	200	11,9	268	232	24	81	145	1,80	1	-
2336 20F0 15	225	13,4	268	235	24	86	150	1,77	1	-
2336 21F0 15	250	14,8	320	285	25	83	158	2,72	1	-
2336 22F0 15	280	16,6	320	291	25	95	180	3,02	1	-
2336 23F0 15	315	18,7	370	335	25	115	190	4,24	1	-
2336 24F0 15	355	21,1	430	373	30	120	200	6,27	1	-
2336 25F0 15	400	23,7	482	427	33	122	210	8,20	1	-
2336 26F0 15	450	26,7	575	514	46	184	300	9,80	1	-
2336 27F0 15	500	29,7	575	530	46	189	295	17,0	1	-
2336 28F0 35	560	33,2	685	615	50	10	120	12,3	1	-
2336 29F0 15	630	37,4	685	642	50	205	305	12,8	1	-
2336 30F0 35	710	42,1	800	737	50	20	120	18,9	1	-
2336 31F0 35	800	47,4	905	840	52	18	120	24,3	1	-
2336 32F0 35	900	53,3	1005	944	55	15	120	33,3	1	-
2336 33F0 35	1000	59,3	1110	1047	60	10	140	43,0	1	-



Zubehör Flanschverbindung PE (V-Bund) • Accessories Flange Connection PE (V-Bund)



Losflansch
Flange loose

D [mm]	DN [mm]	PP-St			St beschichtet St coated	PP-GGG	PP-St
		DIN/EN				ANSI	
		PN10/16	PN10	PN16	PN10	150 lbs	
25	20	9141 07E1 15				9141 07A2 38	
32	25	9141 08E1 15				9141 08A2 38	
40	32	9141 09E1 15				9141 09A2 38	
50	40	9141 10E1 15				9141 10A2 38	
63	50	9141 11E1 15			9151 11A2 25		
75	65	9141 12E1 15				9141 12A2 38	
90	80	9143 13E1 15			9153 13A2 25		
110	100	9143 14E1 15			9153 14A2 25		
125	100	9143 15E1 15				9143 14A2 38	
140	125	9143 16E1 15					
160	150	9143 17E1 15			9153 17A2 25		
180	150	9143 18E1 15			9153 18A2 35		
200	200		9143 19E2 15	9143 19E3 35	9153 19A2 25		
225	200		9143 20E2 15	9143 20E3 35	9153 19A2 25		
250	250		9143 21E2 15	9143 21E3 35	9153 21A2 25		
280	250		9143 22E2 15	9143 22E3 35			
315	300		9143 23E2 15	9143 23E3 35	9153 23A2 25		
355	350		9143 24E2 15	9143 24E3 35		9143 24A2 38	
400	400		9143 25E2 15	9143 25E3 35		9143 25A2 38	
450	500		9143 26E2 35				
500	500		9143 27E2 35			9143 27A2 38	
560	600		9143 28E2 35				
630	600		9143 29E2 35				
710	700			9113 30E2 05			
800	800			9113 31E2 05			
900	900			9113 32E2 05			
1000	1000			9113 33E2 05			



Blindflansch
Flange blind

D [mm]	DN [mm]	PP-St		
		DIN/EN		ANSI
		PN10/16	PN10	150 lbs
25	20	9144 07E1 35		9144 07A2 38
32	25	9144 08E1 35		9144 08A2 38
40	32	9144 09E1 35		9144 09A2 38
50	40	9144 10E1 35		9144 10A2 38
63	50	9144 11E1 35		9144 11A2 38
75	65	9144 12E1 35		9144 12A2 38
90	80	9144 13E1 35		9144 13 A2 38
110	100	9144 14E1 35		9144 14 A2 38
125	100	9144 14E1 35		
140	125	9144 16E1 35		
160	150	9144 17E1 35		9144 17A2 38
180	150	9144 17E1 35		
200	200		9144 19E2 35	9144 19A2 38
225	200		9144 19E2 35	
250	250		9144 21E2 35	9144 21A2 38
280	250		9144 21E2 35	
315	300		9144 23E2 35	9144 23A2 38
355	350		9144 24E2 35	
400	400		9144 25E2 35	
450	500			
500	500			
560	600			
630	600			



Flachdichtring mit Stahleinlage
Flat gasket with steel-inlay

EPDM		NBR	
Wasser / Water		Gas / Gas	
SDR11	SDR17	SDR11	SDR17
9203 07F1 35		9203 07F2 35	
9203 08F1 35		9203 08F2 35	
9203 09F1 35		9203 09F2 35	
9203 10F1 35		9203 10F2 35	
9203 11F1 35		9203 11F2 35	
9203 12F1 35	9204 12F1 35	9203 12F2 35	9204 12F2 35
9203 13F1 35	9204 13F1 35	9203 13F2 35	9204 13F2 35
9203 14F1 35	9204 14F1 35	9203 14F2 35	9204 14F2 35
9203 15F1 35	9204 15F1 35	9203 15F2 35	9204 15F2 35
9203 16F1 35	9204 16F1 35	9203 16F2 35	9204 16F2 35
9203 17F1 35	9204 17F1 35	9203 17F2 35	9204 17F2 35
9203 18F1 35	9204 18F1 35	9203 18F2 35	9204 18F2 35
9203 19F1 35	9204 19F1 35	9203 19F2 35	9204 19F2 35
9203 20F1 35	9204 20F1 35	9203 20F2 35	9204 20F2 35
9203 21F1 35	9204 21F1 35	9203 21F2 35	9204 21F2 35
9203 22F1 35	9204 22F1 35	9203 22F2 35	9204 22F2 35
9203 23F1 35	9204 23F1 35	9203 23F2 35	9204 23F2 35
9203 24F1 35	9204 24F1 35	9203 24F2 35	9204 24F2 35
9203 25F1 35	9204 25F1 35	9203 25F2 35	9204 25F2 35
9203 26F1 35	9204 26F1 35	9203 26F2 35	9204 26F2 35
9203 27F1 35	9204 27F1 35	9203 27F2 35	9204 27F2 35
9203 28F1 35	9204 28F1 35	9203 28F2 35	9204 28F2 35
9203 29F1 35	9204 29F1 35	9203 29F2 35	9204 29F2 35



2.04 E-Formteile • E-Fittings

E-Formteile = Formteile für Heizwendel-Muffen-Schweißung, monofilar.

E-Fittings = Fittings for electrofusion socket-welding, monofilar.

PE100 Heizwendel-Muffen-Schweiß-Formteile

Die Formteile besitzen einen Barcode und können somit mit allen modernen Schweißgeräten mit Barcode-Leseeinrichtungen verschweißt werden. Bei älteren Schweißgeräten werden die Schweißdaten manuell eingegeben. Alle Formteile besitzen einen Schweißindikator.

PE100 Electrofusion socket-welding-fittings

The fittings are equipped with a barcode and can be welded by any modern welding machine coming with a barcode reader. Older machines have to put in the welding dates manually. All fittings are provided with a welding control indicator.

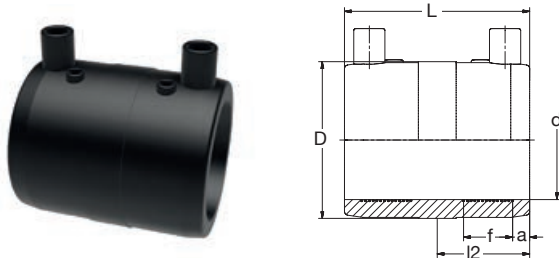

BR PE100 E-Muffe **SDR11** schwarz
BR PE100 E-Socket **SDR11** black

Art Nr	d	D	L	l ₂	a	f	KG	VE1	VE2
Art No	[mm]	[mm]						PU1	PU2
2HM4 0600 35	20	33	70	33	13	15	0,045	1	60
2HM4 0700 35	25	38	70	33	12	15	0,055	1	50
2HM4 0800 35	32	46	80	38	12	19	0,075	1	40
2HM4 0900 35	40	56	90	44	13	22	0,11	1	30
2HM4 1000 35	50	68	100	49	14	23	0,16	1	20
2HM4 1100 35	63	82	111	54	18	26	0,23	1	18
2HM4 1200 35	75	93	121	60	18	32	0,26	1	24
2HM4 1300 35	90	113	131	65	20	31	0,42	1	32
2HM4 1400 35	110	137	140	70	22	32	0,63	1	22
2HM4 1500 35	125	152	152	76	18	38	0,82	1	16
2HM4 1600 35	140	170	161	80	17	49	1,06	1	30
2HM4 1700 35	160	198	172	86	22	45	1,52	1	24
2HM4 1800 35	180	223	200	100	25	51	2,12	1	18
2HM4 1900 35	200	245	210	105	32	43	3,02	1	14
2HM4 2000 35	225	277	225	112	36	48	3,98	1	24
2HM4 2100 35	250	305	244	122	33	53	5,43	1	22
2HM4 2200 35	280	341	265	133	38	55	7,10	1	12
2HM4 2300 35	315	391	277	138	47	51	10,6	1	10
2HM4 2400 35	355	430	312	156	45	60	11,8	1	-
2HM4 2500 35	400	492	344	172	64	53	20,1	1	-

BR PE100 E-Muffe **SDR17** schwarz
BR PE100 E-Socket **SDR17** black

Art Nr	d	D	L	l ₂	a	f	KG	VE1	VE2
Art No	[mm]	[mm]						PU1	PU2
2HM6 0800 35	32	46	80	38	12	19	0,075	1	32
2HM6 0900 35	40	56	90	44	13	22	0,11	1	
2HM6 1000 35	50	68	100	49	14	23	0,16	1	
2HM6 1100 35	63	82	111	54	18	26	0,23	1	
2HM6 1400 35	110	137	140	70	18	36	0,68	1	22
2HM6 1500 35	125	153	152	76	18	39	1,06	1	16
2HM6 1700 35	160	198	172	86	22	39	1,52	1	24
2HM6 1800 35	180	223	200	100	25	41	2,12	1	18
2HM6 1900 35	200	233	212	106	32	41	2,00	1	14
2HM6 2000 35	225	262	227	114	34	41	2,80	1	24
2HM6 2100 35	250	292	244	122	41	45	3,90	1	22
2HM6 2200 35	280	341	265	133	44	42	7,10	1	12
2HM6 2300 35	315	369	275	138	44	47	7,00	1	10
2HM6 2400 35	355	430	312	156	47	40	11,8	1	-
2HM6 2500 35	400	461	340	170	41	60	14,2	1	-

2.04 E-Formteile • E-Fittings

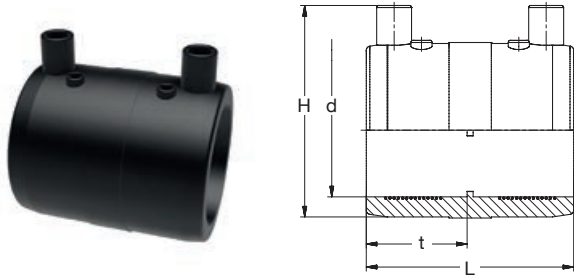

BR PE100 E-Muffe **SDR11** schwarz

BR PE100 E-Socket **SDR11** black

Art Nr	d	t	L	H	KG	VE1	VE2
Art No	[mm]		[mm]			PU1	PU2
2HM4 2600 35	450	170,0	340	555	29,1	1	-
2HM4 2700 35	500	180,0	360	600	34,1	1	-
2HM4 2800 35	560	200,0	400	710	50,9	1	-
2HM4 2900 35	630	220,0	440	800	70,3	1	-
2HM4 3000 35	710	250,0	500	812	91,4	1	-
2HM4 3100 35	800	250,0	500	900	109,0	1	-
2HM4 3200 35	900	270,0	540	1000		1	-
2HM4 3300 35	1000	325,0	650	1370		1	-

Zur Verwendung als Schiebemuffe kann der mittige Anschlag entfernt werden.
For use as a slidding socket, the middle stop can be removed.

Kein Lagerartikel / Not a stock them

BR PE100 E-Muffe **SDR17** schwarz

BR PE100 E-Socket **SDR17** black

Art Nr	d	t	L	H	KG	VE1	VE2
Art No	[mm]		[mm]			PU1	PU2
2HM6 1300 35	90	71	145	128	0,40	1	32
2HM6 1600 35	140	96	195	180	1,10	1	30
2HM6 2600 35	450	170	340	555	13,2	1	-
2HM6 2700 35	500	180	360	600	19,5	1	-
2HM6 2800 35	560	200	400	710	28,5	1	-
2HM6 2900 35	630	220	440	800	39,3	1	-
2HM6 3000 35	710	250	500	812	51,9	1	-
2HM6 3100 35	800	250	500	900	68,0	1	-
2HM6 3200 35	900	270	540	1000	65,0	1	-
2HM6 3300 35	1000	325	650	1370		1	-

Zur Verwendung als Schiebemuffe kann der mittige Anschlag entfernt werden.
For use as a slidding socket, the middle stop can be removed.

Kein Lagerartikel / Not a stock them

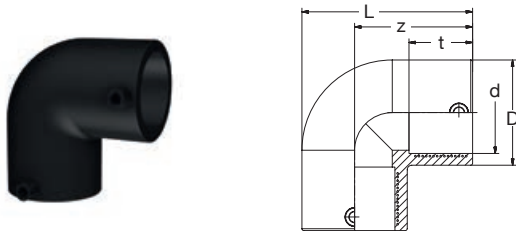

BR PE100 E-Winkel 90° **SDR11** schwarz

BR PE100 E-Elbow 90° **SDR11** black

Art Nr	d	D	L	t	z	KG	VE1	VE2
Art No	[mm]		[mm]				PU1	PU2
2HW4 0790 35	25	38	71	33	57	0,080	1	30
2HW4 0890 35	32	46	85	39	75	0,13	1	20
2HW4 0990 35	40	56	104	48	80	0,19	1	20
2HW4 1090 35	50	68	122	54	89	0,30	1	15
2HW4 1190 35	63	83	135	52	104	0,45	1	8
2HW4 1290 35	75	97	161	64	116	0,67	1	6
2HW4 1390 35	90	116	186	70	130	1,04	1	14
2HW4 1490 35	110	142	218	76	146	1,62	1	10
2HW4 1590 35	125	162	241	79	152	2,13	1	8
2HW4 1690 35	140	174	259	85	166	2,70	1	8
2HW4 1790 35	160	206	295	89	180	4,05	1	8
2HW4 1890 35	180	226	342	116	215	4,80	1	5
2HW4 1990 35	200	251	369	118	229	6,45	1	-
2HW4 2090 35	225	281	401	120	251	9,30	1	-
2HW4 2190 35	250	310	437	127	272	11,6	1	-
2HW4 2390 35	315	397	542	145	321	23,0	1	-

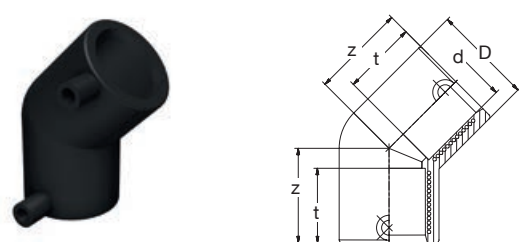

BR PE100 E-Winkel 45° **SDR11** schwarz

BR PE100 E-Elbow 45° **SDR11** black

Art Nr	d	D	t	z	KG	VE1	VE2
Art No	[mm]		[mm]			PU1	PU2
2HW4 0745 35	25	39	33	55	0,08	1	40
2HW4 0845 35	32	46	39	57	0,11	1	30
2HW4 0945 35	40	56	48	70	0,18	1	20
2HW4 1045 35	50	68	54	75	0,26	1	16
2HW4 1145 35	63	82	52	86	0,39	1	8
2HW4 1245 35	75	97	64	98	0,61	1	6
2HW4 1345 35	90	116	70	110	0,91	1	20
2HW4 1445 35	110	142	76	114	1,42	1	12
2HW4 1545 35	125	162	79	119	1,83	1	8
2HW4 1645 35	140	177	86	134	2,20	1	8
2HW4 1745 35	160	206	89	134	3,40	1	12
2HW4 1845 35	180	223	105	165	4,30	1	6
2HW4 1945 35	200	250	112	171	5,30	1	-
2HW4 2045 35	225	281	120	185		1	-
2HW4 2145 35	250	310	127	199		1	-
2HW4 2345 35	315	397	145	230		1	-

2.04 E-Formteile • E-Fittings

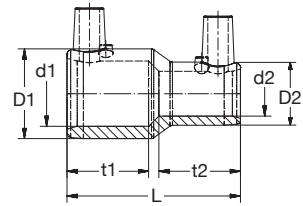
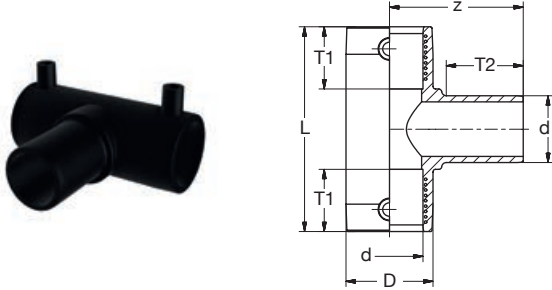

BR PE100 E-T-Stück 90° mit Schweißstutzen **SDR11** schwarz
BR PE100 E-Tee 90° with spigot **SDR11** black

BR PE100 E-Reduktion **SDR11** schwarz
BR PE100 E-Reducer **SDR11** black

Art Nr	d	D	L	T1	T2	z1	z2	KG	VE1	VE2
Art No	[mm]			[mm]					PU1	PU2
2HT4 0790 35	25	39	106	37	60	40	91,5	0,090	1	30
2HT4 0890 35	32	44	128	44	48	40	72	0,14	1	25
2HT4 0990 35	40	54	146	49	53	48	85	0,23	1	16
2HT4 1090 35	50	66	162	55	62	52	95	0,33	1	10
2HT4 1190 35	63	81	188	61	72	66	112,5	0,53	1	6
2HT4 1290 35	75	96	226	64	75	98	128	0,61	1	4
2HT4 1390 35	90	116	250	70	85	110	144	1,10	1	10
2HT4 1490 35	110	141	282	76	84	130	162,5	1,68	1	7
2HT4 1590 35	125	161	312	79	100	154	188,5	2,45	1	5
2HT4 1690 35	140	174	300	85	121	130	221	3,20	1	-
2HT4 1790 35	160	206	368	89	127	190	247	3,86	1	8
2HT4 1890 35	180	227	396	105	130	166	254,5	4,26	1	4
2HT4 1990 35	200	252	410	112	135	186	274	9,18	1	-

Art Nr	d1-d2	D1	D2	L	t1	t2	z	KG	VE1	VE2
Art No	[mm]				[mm]				PU1	PU2
2HR4 0706 35	25-20	37	32	86	40	40	6	1	40	-
2HR4 0806 35	32-20	44	32	105	46	38	21	0,061	1	30
2HR4 0807 35	32-25	45	36	103	44	45	14	0,063	1	20
2HR4 0906 35	40-20	55	33	120	49	39	32	0,083	1	20
2HR4 0907 35	40-25	55	36	114	48	40	26	0,084	1	20
2HR4 0908 35	40-32	55	44	109	54	50	5	0,085	1	20
2HR4 1007 35	50-25	67	37	126	49	40	37	0,12	1	20
2HR4 1008 35	50-32	66	44	121	53	49	19	0,12	1	20
2HR4 1009 35	50-40	66	54	119	55	54	10	0,13	1	10
2HR4 1108 35	63-32	81	46	156	62	44	50	0,19	1	16
2HR4 1109 35	63-40	81	54	137	63	54	20	0,20	1	12
2HR4 1110 35	63-50	81	66	131	62	54	15	0,22	1	12
2HR4 1210 35	75-50	97	68	154	70	55	29	0,37	1	12
2HR4 1211 35	75-63	97	81	160	75	62	23	0,41	1	12
2HR4 1310 35	90-50	117	66	185	79	55	51	0,56	1	16
2HR4 1311 35	90-63	115	81	160	77	62	21	0,52	1	30
2HR4 1312 35	90-75	115	97	159	81	60	18	0,55	1	20
2HR4 1411 35	110-63	144	83	201	79	63	59	0,91	1	24
2HR4 1413 35	110-90	141	115	181	87	77	17	0,86	1	24
2HR4 1511 35	125-63	149	158	69,5	63	0,65	1	20	-	-
2HR4 1513 35	125-90	162	118	177	78	68	31	1,10	1	16
2HR4 1514 35	125-110	162	144	164	79	73	12	1,23	1	16
2HR4 1713 35	160-90	209	119	233	90	79	64	2,34	1	12
2HR4 1714 35	160-110	208	144	218	95	82	41	2,40	1	12
2HR4 1715 35	160-125	208	162	208	98	87	23	2,51	1	8
2HR4 1815 35	180-125	229	165	254	103	79	72	3,14	1	-
2HR4 1917 35	200-160	254	228	265	110	96	59	4,00	1	-
2HR4 2017 35	225-160							3,74	1	6



2.05 Rohrbögen nahtlos • Pipe bends seamless

PE100 Rohrbögen nahtlos SDR11/17 in 90°/60°/45°/30°/22°/11° schwarz

mit langen Schweißenden für Stumpf- und Heizwendel-Muffen-Schweißung

Werkstoff

Wahlweise PE100 oder PE-RC (rissbeständig), schwarz.
PE-RC = weiterentwickelter PE100 Werkstoff mit erhöhter Spannungsrisssbeständigkeit.

Geometrische Eigenschaften

Abmessungen und Toleranzen entsprechend EN 1555-2 und EN 12201-2, sowie ISO 4427-2 und ISO 4437-2.

Winkelangaben: Toleranz +/- 3°.

Längenangaben: Minimum Maße

$r \approx 1,5 \times d$

Ausführung

Geeignet für Stumpf- und Heizwendel-Muffen-Schweißung.

Geeignet für Gas & Trinkwasser.

Die Bögen sind vorwiegend für den Einsatz im Tiefbau vorgesehen. Im Anlagen- bzw. Industriebau kann es bedingt durch den relativ großen Toleranzbereich beim Winkelmaß von $\pm 3^\circ$ zu Montageproblemen kommen. Beanstandungen auf Grund dieser Gegebenheiten können wir nicht anerkennen.

Lieferung

Bis D355 Lagerware.

Weitere Abmessungen, Radien $r \approx 2,5 \times d$ und Gradzahlen auf Anfrage. Alternativ können die Bögen auch in PE-RC Material geliefert werden.

PE100 Pipe bends seamless SDR11/17 in 90°/60°/45°/30°/22°/11° black

with long spigots for butt- and electrofusion socket-welding

Material

Selectively PE100 or PE-RC (resistance to crack), black.
PE-RC = further developed PE100 material with increased stress crack resistance.

Geometric Properties

Dimensions and tolerances according to EN 1555-2 and EN 12201-2, plus ISO 4427-2 and ISO 4437-2.

Angles: Tolerance +/- 3°.

Length: minimum sizes.

$r \approx 1,5 \times d$

Type

Suitable for butt- and electrofusion-socket-welding.

Suitable for Gas & Drinking water.

The bends are mainly designated for underground work application. At applications for plant and industrial engineering installation problems might arise due to the relatively high tolerance range having an angular measure of $\pm 3^\circ$. Any claims caused by these conditions will be rejected.

Delivery

Upt to D355 on stock.

Further sizes, radii $r \approx 2,5 \times d$ and degrees on request. Alternatively we are able to supply the bends in PE-RC material.

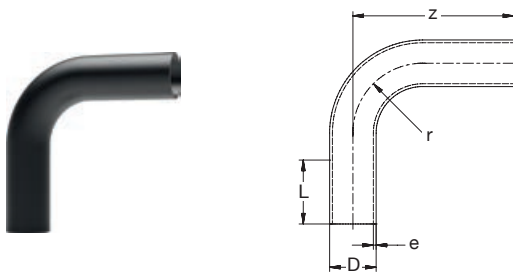

BR PE100 Rohrbogen 90° nahtlos lang **SDR11** schwarz

BR PE100 Pipe bend 90° seamless long **SDR11** black

Art Nr	D	e	L	r	z	KG	VE1
Art No	[mm]		[mm]				PU1
2433 1190 25	63	5,8	100	95	160	0,40	1
2433 1290 25	75	6,8	100	113	170	0,70	1
2433 1390 25	90	8,2	265	135	400	1,60	1
2433 1490 25	110	10,0	240	165	405	2,40	1
2433 1590 25	125	11,4	220	188	408	3,10	1
2433 1690 25	140	12,7	265	210	475	4,50	1
2433 1790 25	160	14,6	245	240	485	5,90	1
2433 1890 25	180	16,4	285	270	555	8,60	1
2433 1990 25	200	18,2	260	300	560	10,6	1
2433 2090 25	225	20,5	235	338	573	15,0	1
2433 2190 25	250	22,7	270	375	645	18,4	1
2433 2290 25	280	25,4	235	420	655	23,2	1
2433 2390 25	315	28,6	255	470	725	32,5	1
2433 2490 25	355	32,2	270	530	800	75,4	1
2433 2590 25	400	36,3	300	637	1050	72,7	1
2433 2690 25	450	40,9	300	711	1150	100,6	1
2433 2790 25	500	45,4	350	783	1300	140,9	1
2433 2890 25	560	50,8	350	877	1350	181,2	1
2433 2990 25	630	57,2	350	965	1600	275,6	1
2433 3090 25	710	64,5	350	1128	1900	416,2	1
2433 3190 25	800	72,6	350	1274	2000	549,8	1
2433 3290 25	900	81,7	400	1430	2200	763,2	1

BR PE100 Rohrbogen 90° nahtlos lang **SDR17** schwarz

BR PE100 Pipe bend 90° seamless long **SDR17** black

Art Nr	D	e	L	r	z	KG	VE1
Art No	[mm]		[mm]				PU1
2434 1190 25	63	3,8	100	95	180	0,30	1
2434 1290 25	75	4,5	100	113	220	0,50	1
2434 1390 25	90	5,4	265	135	378	1,10	1
2434 1490 25	110	6,6	240	165	375	1,70	1
2434 1590 25	125	7,4	220	188	379	2,10	1
2434 1690 25	140	8,3	320	210	441	3,10	1
2434 1790 25	160	9,5	245	240	449	4,00	1
2434 1890 25	180	10,7	285	270	511	5,80	1
2434 1990 25	200	11,9	260	300	508	7,20	1
2434 2090 25	225	13,4	235	338	520	10,20	1
2434 2190 25	250	14,8	270	375	582	12,50	1
2434 2290 25	280	16,6	235	420	582	15,70	1
2434 2390 25	315	18,7	255	470	651	22,10	1
2434 2490 25	355	21,1	270	530	716	30,90	1
2434 2590 25	400	23,7	300	637	780	49,10	1
2434 2690 25	450	26,7	300	711	820	68,00	1
2434 2790 25	500	29,7	350	783	960	95,30	1
2434 2890 25	560	33,2	350	877	980	122,50	1
2434 2990 25	630	37,4	350	955	1200	186,40	1
2434 3090 25	710	42,1	350	1128	1450	281,10	1
2434 3190 25	800	47,4	350	1274	1500	371,40	1
2434 3290 25	900	53,3	400	1430	1650	515,20	1

2.05 Rohrbögen nahtlos • Pipe bends seamless

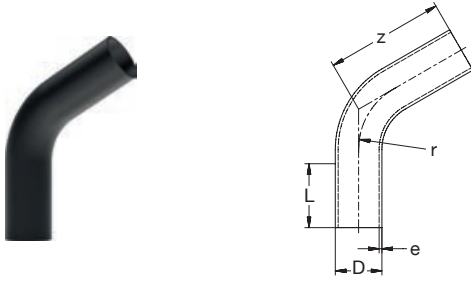

BR PE100 Rohrbogen 60° nahtlos lang **SDR11** schwarz
BR PE100 Pipe bend 60° seamless long **SDR11** black

Art Nr Art No	D [mm]	e	L	r	z	KG	VE1 PU1
2433 1160 25	63	5,8	100	95	180	0,30	1
2433 1260 25	75	6,8	100	113	220	0,60	1
2433 1360 25	90	8,2	300	135	378	1,60	1
2433 1460 25	110	10,0	280	165	375	2,40	1
2433 1560 25	125	11,4	270	188	379	3,10	1
2433 1660 25	140	12,7	320	210	441	4,50	1
2433 1760 25	160	14,6	310	240	449	5,90	1
2433 1860 25	180	16,4	355	270	511	8,60	1
2433 1960 25	200	18,2	335	300	508	10,60	1
2433 2060 25	225	20,5	325	338	520	15,0	1
2433 2160 25	250	22,7	365	375	582	18,4	1
2433 2260 25	280	25,4	304	420	585	23,2	1
2433 2360 25	315	28,6	380	470	651	32,5	1
2433 2460 25	355	32,2	410	430	716	45,4	1
2433 2560 25	400	36,3	300	637	780	59,4	1
2433 2660 25	450	40,9	300	711	820	78,9	1
2433 2760 25	500	45,4	300	783	960	114,2	1
2433 2860 25	560	50,8	350	877	980	145,5	1
2433 2960 25	630	57,2	350	955	1200	226,9	1
2433 3060 25	710	64,5	350	1128	1450	348,8	1
2433 3160 25	800	72,6	350	1274	1500	455,9	1
2433 3260 25	900	81,7	400	1430	1650	634,2	1

BR PE100 Rohrbogen 60° nahtlos lang **SDR17** schwarz
BR PE100 Pipe bend 60° seamless long **SDR17** black

Art Nr Art No	D [mm]	e	L	r	z	KG	VE1 PU1
2434 1160 25	63	3,8	100	95	180	0,20	1
2434 1260 25	75	4,5	100	113	220	0,40	1
2434 1360 25	90	5,4	300	135	378	1,10	1
2434 1460 25	110	6,6	280	165	375	1,70	1
2434 1560 25	125	7,4	270	188	379	2,10	1
2434 1660 25	140	8,3	320	210	441	3,10	1
2434 1760 25	160	9,5	310	240	449	4,00	1
2434 1860 25	180	10,7	355	270	511	5,80	1
2434 1960 25	200	11,9	335	300	508	7,20	1
2434 2060 25	225	13,4	325	338	520	10,20	1
2434 2160 25	250	14,8	365	375	582	12,5	1
2434 2260 25	280	16,6	304	420	582	15,7	1
2434 2360 25	315	18,7	380	470	651	22,1	1
2434 2460 25	355	21,1	410	530	716	30,9	1
2434 2560 25	400	23,7	300	637	780	40,1	1
2434 2660 25	450	26,7	300	711	820	53,3	1
2434 2760 25	500	29,7	300	783	960	77,3	1
2434 2860 25	560	33,2	350	877	980	98,4	1
2434 2960 25	630	37,4	350	955	1200	153,3	1
2434 3060 25	710	42,1	350	1128	1450	235,6	1
2434 3160 25	800	47,4	350	1274	1500	307,9	1
2434 3260 25	900	53,3	400	1430	1650	428,1	1

2.05 Rohrbögen nahtlos • Pipe bends seamless

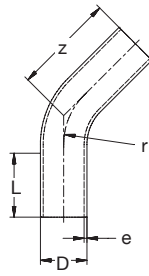

BR PE100 Rohrbogen 45° nahtlos lang **SDR11** schwarz
BR PE100 Pipe bend 45° seamless long **SDR11** black

Art Nr	D	e	L	r	z	KG	VE1
Art No	[mm]	[mm]				PU1	
2433 1145 25	63	5,8	100	95	170	0,30	1
2433 1245 25	75	6,8	100	113	180	0,40	1
2433 1345 25	90	8,2	320	135	376	1,60	1
2433 1445 25	110	10,0	305	165	373	2,40	1
2433 1545 25	125	11,4	295	188	373	3,10	1
2433 1645 25	140	12,7	350	210	437	4,50	1
2433 1745 25	160	14,6	340	240	439	5,90	1
2433 1845 25	180	16,4	390	270	502	8,60	1
2433 1945 25	200	18,2	375	300	499	10,60	1
2433 2045 25	225	20,5	365	338	505	15,00	1
2433 2145 25	250	22,7	415	375	570	18,40	1
2433 2245 25	280	25,4	395	420	569	23,20	1
2433 2345 25	315	28,6	440	470	635	32,50	1
2433 2445 25	355	32,2	480	530	700	45,40	1
2433 2545 25	400	36,3	300	637	670	52,20	1
2433 2645 25	450	40,9	300	711	750	74,10	1
2433 2745 25	500	45,4	300	783	900	109,90	1
2433 2845 25	560	50,8	350	877	950	145,20	1
2433 2945 25	630	57,2	350	955	1000	193,50	1
2433 3045 25	710	64,5	350	1128	1300	320,30	1
2433 3145 25	800	72,6	350	1274	1400	437,10	1
2433 3245 25	900	81,7	400	1430	1500	592,30	1

BR PE100 Rohrbogen 45° nahtlos lang **SDR17** schwarz
BR PE100 Pipe bend 45° seamless long **SDR17** black

Art Nr	D	e	L	r	z	KG	VE1
Art No	[mm]	[mm]				PU1	
2434 1145 25	63	3,8	100	95	170	0,20	1
2434 1245 25	75	4,5	100	113	180	0,30	1
2434 1345 25	90	5,4	320	135	376	1,10	1
2434 1445 25	110	6,6	305	165	373	1,70	1
2434 1545 25	125	7,4	295	188	373	2,10	1
2434 1645 25	140	8,3	350	210	437	3,10	1
2434 1745 25	160	9,5	340	240	439	4,00	1
2434 1845 25	180	10,7	390	270	502	5,80	1
2434 1945 25	200	11,9	375	300	499	7,20	1
2434 2045 25	225	13,4	365	338	505	10,20	1
2434 2145 25	250	14,8	415	375	570	12,50	1
2434 2245 25	280	16,6	395	420	569	15,70	1
2434 2345 25	315	18,7	440	470	635	22,10	1
2434 2445 25	355	21,1	480	530	700	30,90	1
2434 2545 25	400	23,7	300	637	670	42,00	1
2434 2645 25	450	26,7	300	711	750	50,10	1
2434 2745 25	500	29,7	300	783	900	74,40	1
2434 2845 25	560	33,2	350	877	950	98,20	1
2434 2945 25	630	37,4	350	955	1000	130,90	1
2434 3045 25	710	42,1	350	1128	1300	216,30	1
2434 3145 25	800	47,4	350	1274	1400	285,30	1
2434 3245 25	900	53,3	400	1430	1500	399,80	1

2.05 Rohrbögen nahtlos • Pipe bends seamless

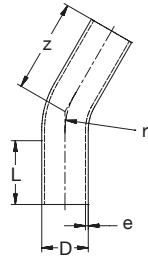

BR PE100 Rohrbogen 30° nahtlos lang **SDR11** schwarz
BR PE100 Pipe bend 30° seamless long **SDR11** black

Art Nr Art No	D [mm]	e	L	r	z	KG	VE1 PU1
2433 1130 25	63	5,8	100	95	160	0,30	1
2433 1230 25	75	6,8	100	113	170	0,50	1
2433 1330 25	90	8,2	335	135	371	1,60	1
2433 1430 25	110	10,0	325	165	369	2,40	1
2433 1530 25	125	11,4	320	188	370	3,10	1
2433 1630 25	140	12,7	380	210	436	4,50	1
2433 1730 25	160	14,6	370	240	434	5,90	1
2433 1830 25	180	16,4	425	270	497	8,60	1
2433 1930 25	200	18,2	420	300	310	10,60	1
2433 2030 25	225	20,5	410	338	501	15,00	1
2433 2130 25	250	22,7	460	375	560	18,40	1
2433 2230 25	280	25,4	450	420	563	23,20	1
2433 2330 25	315	28,6	500	470	626	32,50	1
2433 2430 25	355	32,2	550	530	692	36,80	1
2433 2530 25	400	36,3	300	637	650	45,40	1
2433 2630 25	450	40,9	300	711	700	51,40	1
2433 2730 25	500	45,4	300	783	750	70,20	1
2433 2830 25	560	50,8	350	877	800	92,70	1
2433 2930 25	630	57,2	350	955	850	123,9	1
2433 3030 25	710	64,5	350	1128	1150	287,0	1
2433 3130 25	800	72,6	350	1274	1250	395,6	1
2433 3230 25	900	81,7	400	1430	1350	540,7	1

BR PE100 Rohrbogen 30° nahtlos lang **SDR17** schwarz
BR PE100 Pipe bend 30° seamless long **SDR17** black

Art Nr Art No	D [mm]	e	L	r	z	KG	VE1 PU1
2434 1130 25	63	3,8	100	95	160	0,20	1
2434 1230 25	75	4,5	100	113	170	0,30	1
2434 1330 25	90	5,4	335	135	371	1,10	1
2434 1430 25	110	6,6	325	165	369	1,70	1
2434 1530 25	125	7,4	320	188	370	2,10	1
2434 1630 25	140	8,3	380	210	436	3,10	1
2434 1730 25	160	9,5	370	240	434	4,00	1
2434 1830 25	180	10,7	425	270	497	5,80	1
2434 1930 25	200	11,9	420	300	310	7,20	1
2434 2030 25	225	13,4	410	338	501	10,20	1
2434 2130 25	250	14,8	460	375	560	12,50	1
2434 2230 25	280	16,6	450	420	563	15,70	1
2434 2330 25	315	18,7	500	470	626	22,10	1
2434 2430 25	355	21,1	550	530	692	30,90	1
2434 2530 25	400	23,7	300	637	650	34,70	1
2434 2630 25	450	26,7	300	711	700	47,40	1
2434 2730 25	500	29,7	300	783	750	62,80	1
2434 2830 25	560	33,2	350	877	800	83,80	1
2434 2930 25	630	37,4	350	955	850	112,80	1
2434 3030 25	710	42,1	350	1128	1150	193,80	1
2434 3130 25	800	47,4	350	1274	1250	267,20	1
2434 3230 25	900	53,3	400	1430	1350	365,00	1

2.05 Rohrbögen nahtlos • Pipe bends seamless

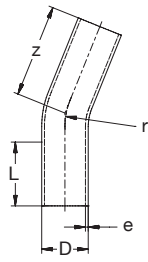

BR PE100 Rohrbogen 22° nahtlos lang **SDR11** schwarz
BR PE100 Pipe bend 22° seamless long **SDR11** black

Art Nr	D	e	L	r	z	KG	VE1
Art No	[mm]	[mm]					PU1
2433 1122 25	63	5,8	100	95	160	0,30	1
2433 1222 25	75	6,8	100	113	170	0,50	1
2433 1322 25	90	8,2	345	135	371	1,60	1
2433 1422 25	110	10,0	340	165	372	2,40	1
2433 1522 25	125	11,4	355	188	372	3,10	1
2433 1622 25	140	12,7	390	210	431	4,50	1
2433 1722 25	160	14,6	385	240	432	5,90	1
2433 1822 25	180	16,4	445	270	497	8,60	1
2433 1922 25	200	18,2	435	300	493	10,60	1
2433 2022 25	225	20,5	435	338	501	15,00	1
2433 2122 25	250	22,7	490	375	563	18,40	1
2433 2222 25	280	25,4	480	420	562	23,20	1
2433 2322 25	315	28,6	535	470	626	32,50	1
2433 2422 25	355	32,2	585	530	688	45,40	1
2433 2522 25	400	36,3	300	637	650	51,60	1
2433 2622 25	450	40,9	300	711	700	70,50	1
2433 2722 25	500	45,4	350	783	750	93,10	1
2433 2822 25	560	50,8	350	877	800	124,50	1
2433 2922 25	630	57,2	350	955	850	167,50	1
2433 3022 25	710	64,5	350	1128	1150	288,00	1
2433 3122 25	800	72,6	350	1274	1250	397,10	1
2433 3222 25	900	81,7	400	1430	1350	542,90	1

BR PE100 Rohrbogen 22° nahtlos lang **SDR17** schwarz
BR PE100 Pipe bend 22° seamless long **SDR17** black

Art Nr	D	e	L	r	z	KG	VE1
Art No	[mm]	[mm]					PU1
2434 1122 25	63	3,8	100	95	160	0,20	1
2434 1222 25	75	4,5	100	113	170	0,30	1
2434 1322 25	90	5,4	345	135	371	1,10	1
2434 1422 25	110	6,6	340	165	372	1,70	1
2434 1522 25	125	7,4	355	188	372	2,10	1
2434 1622 25	140	8,3	390	210	431	3,10	1
2434 1722 25	160	9,5	385	240	432	4,00	1
2434 1822 25	180	10,7	445	270	497	5,80	1
2434 1922 25	200	11,9	435	300	493	7,20	1
2434 2022 25	225	13,4	435	338	501	10,20	1
2434 2122 25	250	14,8	490	375	563	12,50	1
2434 2222 25	280	16,6	480	420	562	15,70	1
2434 2322 25	315	18,7	535	470	626	22,10	1
2434 2422 25	355	21,1	585	530	688	30,90	1
2434 2522 25	400	23,7	300	637	650	34,90	1
2434 2622 25	450	26,7	300	711	700	47,60	1
2434 2722 25	500	29,7	300	783	750	63,00	1
2434 2822 25	560	33,2	350	877	800	84,10	1
2434 2922 25	630	37,4	350	955	850	113,30	1
2434 2222 25	710	42,1	350	1128	1150	194,50	1
2434 3122 25	800	47,4	350	1274	1250	268,20	1
2434 3222 25	900	53,3	400	1430	1350	366,40	1

2.05 Rohrbögen nahtlos • Pipe bends seamless

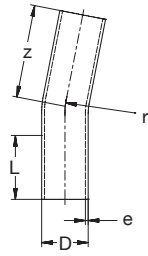

BR PE100 Rohrbogen 11° nahtlos lang **SDR11** schwarz
BR PE100 Pipe bend 11° seamless long **SDR11** black

Art Nr	D	e	L	r	z	KG	VE1
Art No	[mm]	[mm]					PU1
2433 1111 25	63	5,8	100	95	160	0,30	1
2433 1112 25	75	6,8	100	113	170	0,50	1
2433 1311 25	90	8,2	360	135	373	1,60	1
2433 1411 25	110	10,0	355	165	371	2,40	1
2433 1511 25	125	11,4	355	188	373	3,10	1
2433 1611 25	140	12,7	415	210	435	4,50	1
2433 1711 25	160	14,6	410	240	433	5,90	1
2433 1811 25	180	16,4	470	270	496	8,60	1
2433 1911 25	200	18,2	465	300	494	10,60	1
2433 2011 25	225	20,5	465	338	498	15,00	1
2433 2111 25	250	22,7	525	375	561	18,40	1
2433 2211 25	280	25,4	520	420	560	23,20	1
2433 2311 25	315	28,6	580	470	625	32,50	1
2433 2411 25	355	32,2	635	530	686	45,40	1
2433 2511 25	400	36,3	300	637	650	51,70	1
2433 2611 25	450	40,9	300	711	700	70,60	1
2433 2711 25	500	45,4	300	783	750	93,30	1
2433 2811 25	560	50,8	350	877	800	124,70	1
2433 2911 25	630	57,2	350	955	850	167,90	1
2433 3011 25	710	64,5	350	1128	1150	288,60	1
2433 3111 25	800	72,6	350	1274	1250	397,90	1
2433 3211 25	900	81,7	400	1430	1350	544,10	1

BR PE100 Rohrbogen 11° nahtlos lang **SDR17** schwarz
BR PE100 Pipe bend 11° seamless long **SDR17** black

Art Nr	D	e	L	r	z	KG	VE1
Art No	[mm]	[mm]					PU1
2434 1111 25	63	3,8	100	95	160	0,20	1
2434 1112 25	75	4,5	100	113	170	0,30	1
2434 1311 25	90	5,4	360	135	373	1,10	1
2434 1411 25	110	6,6	355	165	371	1,70	1
2434 1511 25	125	7,4	355	188	373	2,10	1
2434 1611 25	140	8,3	415	210	435	3,10	1
2434 1711 25	160	9,5	410	240	433	4,00	1
2434 1811 25	180	10,7	470	270	496	5,80	1
2434 1911 25	200	11,9	465	300	494	7,20	1
2434 2011 25	225	13,4	465	338	498	10,20	1
2434 2111 25	250	14,8	525	375	561	12,50	1
2434 2211 25	280	16,6	520	420	560	15,70	1
2434 2311 25	315	18,7	580	470	625	22,10	1
2434 2411 25	355	21,1	635	530	686	32,90	1
2434 2511 25	400	23,7	300	637	650	34,90	1
2434 2611 25	450	26,7	300	711	700	47,70	1
2434 2711 25	500	29,7	300	783	750	63,20	1
2434 2811 25	560	33,2	350	877	800	84,30	1
2434 2911 25	630	37,4	350	955	850	113,60	1
2434 1111 25	710	42,1	350	1128	1150	194,90	1
2434 3111 25	800	47,4	350	1274	1250	268,80	1
2434 3211 25	900	53,3	400	1430	1350	367,30	1





3 PP-R

Der Werkstoff PP-R weist gegenüber PE eine erhöhte Steifigkeit, insbesondere im oberen Temperaturbereich, aus. Charakteristisch sind die hohe chemische Beständigkeit und die guten Langzeiteigenschaften gegenüber vielen Medien.

Eigenschaften

- Hohe chemische Beständigkeit
- Korrosionsbeständigkeit
- Hervorragende Verarbeitbarkeit

Werkstoff

PP-R (Polypropylen - Random-Copolymerisat) mit hohem Molekulargewicht und hoch wärmostabilisiert, RAL 6017 Maigrün.

Verbindungstechnik

- Heizelement-Muffen-Schweißung
- Heizwendel-Muffen-Schweißung
- Flanschverbindung

Compared to PE, PP-R has higher rigidity, particularly in the upper temperature range. The high resistance to chemicals and good long term properties compared to many other media are characteristic.

Properties

- Good resistance to chemicals
- Corrosion resistance
- Excellent processing capability

Material

PP-R (Polypropylene - Random-Copolymerisate) with high molecular weight and high-heat stabilised, RAL 6017 May green.

Joining technology

- Socket-welding
- Electrofusion socket-welding
- Flange connection



3.01 Rohre einlagig
Pipes single-layer **PPR 3**

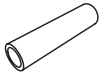

3.02 Formteile Muffen-Schweißen
Fittings socket-welding **PPR 4**

3.02.01 Bögen, Winkel
Elbows, Bends **PPR 4**

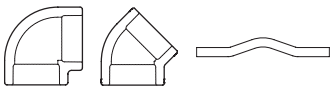

3.02.06 Verschraubungen
Unions **PPR 7**

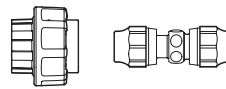

3.02.02 T-Stücke
Tee's **PPR 5**

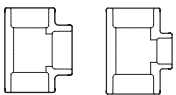

3.02.07 Kugelhähne
Ball valves **PPR 9**

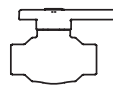

3.02.03 Reduktionen, Muffen, Kappen
Reducers, Sockets, Caps **PPR 5**

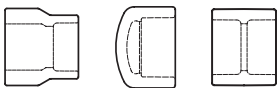

3.02.08 Ventile
Valves **PPR 10**



3.02.04 Übergänge
Transitions **PPR 6**

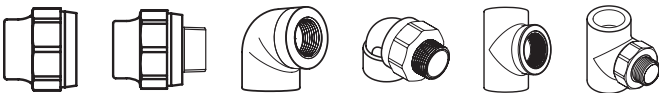

3.02.05 Übergänge Wand
Transitions wall **PPR 7**



3.01 Rohre einlagig • Pipes single-layer

G 8200

Beschreibung

PP-R Druckrohr G 8200, einschichtig, SDR6.
Homogenes Rohr für hohe Drücke in Heiß- und Kaltwassersystemen.

Werkstoff

PP-R (Polypropylen Random-Copolymer), Borealis RA130E oder Sabcic Vestolen P9421-66410, Farbe RAL 6017 Maigrün.
Das Material entspricht den Anforderungen der aktuellen KTW-Leitlinie des Umweltbundesamtes (UBA).

Geometrische Eigenschaften

Abmessungen und Toleranzen entsprechend DIN 8077 und DIN EN ISO 15874-2.

Betriebsdruck

20°C/2,0 MPa • 70°C/1,0 MPa.

Ausführung

Geeignet für Heizelement-Muffen-Schweißung, Heizelement-Stumpf-Schweißung und Heizwendel-Muffen-Schweißung nach DVS Richtlinie 2207. Schweiß-Geräte und Schweiß-Werkzeuge sollten der DVS Richtlinie 2208 entsprechen.

Zertifizierung

B-R Rohre unterliegen regelmäßigen internen und externen Qualitätskontrollen. Die Rohre erfüllen die Anforderungen von AENOR, Bulgarcontrola, DVGW, Lloyds, ÖVGW und Watermark.

Lieferung

In 4 oder 5,8* m Stangen; abgepackt in Bunden. Alle Bunde sind in schwarzer UV-Schutz-Schlauchfolie verpackt. Abgabe erfolgt nur in kompletten Verpackungseinheiten (VEs).

Description

PP-R Pressure pipe G 8200, single-layer, SDR6.
Homogeneous pipe for high pressures in hot and cold water systems.

Material

PP-R (Polypropylene Random-Copolymer), Borealis RA130E or Sabcic Vestolen P9421-66410, colour RAL 6017 May green.
The material complies with the requirements of the KTW guideline of the German Federal Environmental Agency (UBA).

Geometric Properties

Dimensions and tolerances according to DIN 8077 and DIN EN ISO 15874-2.

Operating Pressure

20°C/2.0 MPa • 70°C/1.0 MPa.

Type

Useable for socket-welding, butt-welding and electrofusion-socket-welding according to DVS technical code 2207. Welding equipment according to DVS technical code 2208.

Certification

B-R pipes succumb frequent internal and external quality controls. The pipes fulfill the requirements of AENOR, Bulgarcontrola, DVGW, Lloyds, ÖVGW and Watermark.

Delivery

In 4 or 5,8* m rods; packed in bundles. All bundles are packed in black UV-protection-foil. Supply only in complete packing units (PU's).

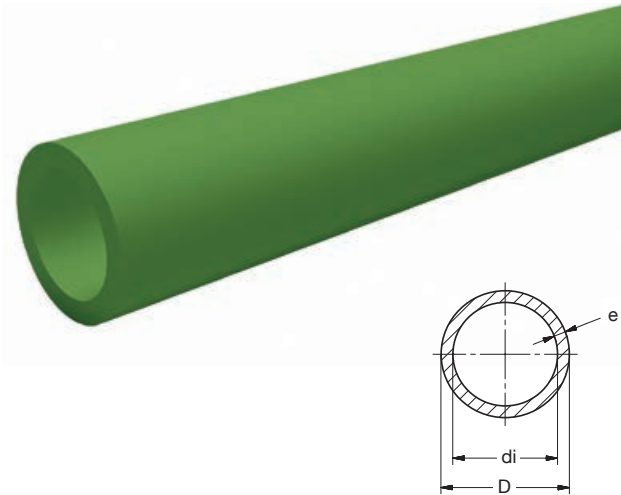

BR PP-R Druckrohr G 8200 SDR6 2,0MPa grün

BR PP-R Pressure-Pipe G 8200 SDR6 2.0MPa green

Art Nr	D	e	DN	di	SDR	L	KG	VE1	VE2
Art No	[mm]			[mm]		[m]		PU1	PU2
20°C / 2,0 MPa • 70°C / 1,0 MPa									
5111 0640 11	20	3,4	12	13,2	6	4	0,18	100	3500
5111 0740 11	25	4,2	14	16,6	6	4	0,28	100	2300
5111 0840 11	32	5,4	20	21,2	6	4	0,46	60	1200
5111 0658 11	20	3,4	12	13,2	6	5,8 *	0,18	145	5075
5111 0758 11	25	4,2	14	16,6	6	5,8 *	0,28	145	3335
5111 0858 11	32	5,4	20	21,2	6	5,8 *	0,46	87	1740

* Kein Lagerartikel / Not a stock them

3.02 Formteile Muffen-Schweißen • Fittings socket-welding

Beschreibung

Gespritzte Formteile (ohne Verschwächungs-Beiwerte), für die Heizelement-Muffen-Schweißung.

Werkstoff

PP-R (Polypropylen Random-Copolymer), Borealis RA130E oder Sabic Vestolen P9421-66410, Farbe RAL 6017 Maigrün.
Das Material entspricht den Anforderungen der aktuellen KTW-Leitlinie des Umweltbundesamtes (UBA).

Geometrische Eigenschaften

Abmessungen und Toleranzen der Muffen entsprechend DIN EN ISO 15874-3; Muffe Typ A.

Toleranzen bei den Z-Maßangaben sind abhängig von der Dimension. Bis d/D 160 = +/- 3 mm.

Betriebsdruck

Der Betriebsdruck richtet sich üblicherweise nach dem eingesetzten Rohr. Grundsätzlich sind alle Standard-Formteile für die angebotenen Rohre geeignet.

Ausführung

Geeignet für Heizelement-Muffen-Schweißung nach DVS Richtlinie 2207. Schweißgeräte und Schweißwerkzeuge sollten der DVS Richtlinie 2208 entsprechen.

Zertifizierung

B-R Formteile unterliegen laufenden internen und externen Qualitätskontrollen. Die Formteile erfüllen die Anforderungen von AENOR, Bulgarcontrola, DVGW, Lloyds, ÖVGW und Watermark.

Lieferung

Abgabe erfolgt nur in kompletten Verpackungseinheiten (VE's).

Description

Injection moulded fittings (without pressure reduction factors), for socket-welding.

Material

PP-R (Polypropylene Random-Copolymer), Borealis RA130E or Sabic Vestolen P9421-66410, colour RAL 6017 May green.
The material complies with the requirements of the KTW guideline of the German Federal Environmental Agency (UBA).

Geometric Properties

Dimensions and tolerances of the sockets according to DIN EN ISO 15874-3; socket type A.

Tolerances of z-sizes depend on the dimension. Up to d/D 160 = +/- 3 mm.

Operating pressure

The operating pressure usually depends on the used pipe. Basically, all standard fittings are suitable for the offered pipes.

Type

Suitable for socket-welding according to DVS technical code 2207. Welding equipment according to DVS technical code 2208.

Certification

B-R fittings succumb internal and external quality controls. The fittings fulfill the requirements of AENOR, Bulgarcontrola, DVGW, Lloyds, ÖVGW and Watermark.

Delivery

Supply only in complete packing units (PU's).

3.02.01 Bögen, Winkel • Bends, Elbows

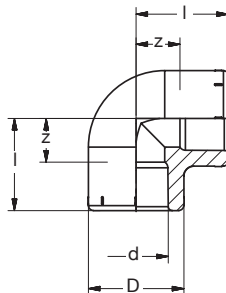

BR PP-R Winkel 90° grün
BR PP-R Elbow 90° green

Art Nr	d	D	l	z	KG	VE1	VE2
Art No	[mm]		[mm]			PU1	PU2
5411 0690 11	20	29	28	13	0,019	10	120
5411 0790 11	25	34	32	16	0,025	10	80
5411 0890 11	32	43	38	20	0,047	10	80

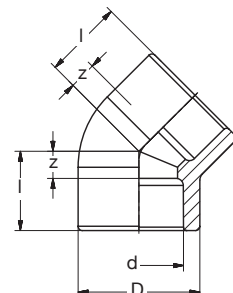

BR PP-R Winkel 45° grün
BR PP-R Elbow 45° green

Art Nr	d	D	l	z	KG	VE1	VE2
Art No	[mm]		[mm]			PU1	PU2
5411 0645 11	20	29	21	6	0,014	10	150
5411 0745 11	25	34	24	8	0,019	10	90
5411 0845 11	32	43	28	10	0,034	10	50



BR PP-R Überspringbogen Rohr SDR7,4 grün
BR PP-R Crossover pipe SDR7.4 green

Art Nr	D	e	H	L	KG	VE1	VE2
Art No	[mm]		[mm]			PU1	PU2
5460 0600 11	20	3,4	≈ 53	≈ 365	0,04	1	60
5460 0700 11	25	4,2	≈ 56	≈ 370	0,07	1	30
5460 0800 11	32	5,4	≈ 68	≈ 370	0,13	1	40

Nur für Kaltwasserleitungen • Only for cold water lines.

3.02.02 T-Stücke • Tee's

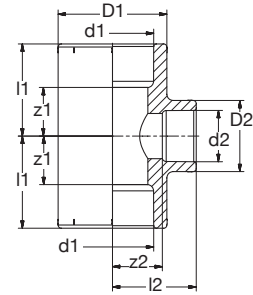
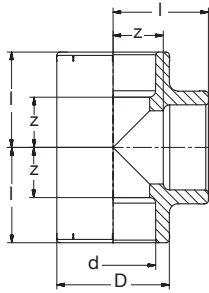

BR PP-R T-Stück 90° grün
BR PP-R Tee 90° green

Art Nr	d	D	l	z	KG	VE1	VE2
Art No	[mm]	[mm]				PU1	PU2
5511 0690 11	20	29	28	13	0,023	10	80
5511 0790 11	25	34	32	16	0,034	10	50
5511 0890 11	32	43	38	20	0,060	5	70

BR PP-R T-Stück 90° red grün
BR PP-R Tee 90° red green

Art Nr	d1-d2	D1	D2	l1	l2	z1	z2	KG	VE1	VE2
Art No	[mm]	[mm]							PU1	PU2
5521 0706 11	25-20	34	29	32	32	16	17	0,035	10	60
5521 0806 11	32-20	43	29	38	36	20	21	0,060	5	30
5521 0807 11	32-25	43	34	38	36	20	22	0,060	5	30

3.02.03 Reduktionen, Muffen, Kappen • Reducers, Sockets, Caps

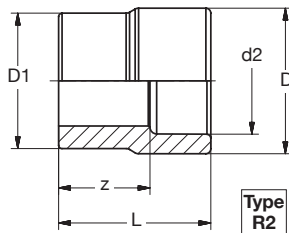
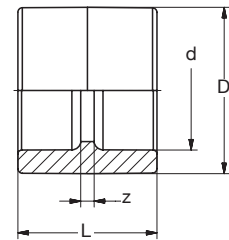
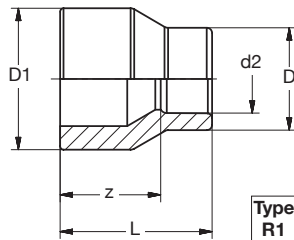

BR PP-R Muffe grün
BR PP-R Socket green

Art Nr	d	D	L	z	KG	VE1	VE2
Art No	[mm]	[mm]				PU1	PU2
5311 0600 11	20	29	34	5	0,010	10	150
5311 0700 11	25	34	37	5	0,015	10	120
5311 0800 11	32	43	41	5	0,026	10	60

BR PP-R Reduktion grün
BR PP-R Reducer green

Art Nr	D1 - d2	Type	D2	L	z	KG	VE1	VE2
Art No	[mm]	R1 R2	[mm]				PU1	PU2
5321 0706 11	25-20	•	29	36	22	0,012	10	100
5321 0806 11	32-20	•	29	37	23	0,015	10	80
5321 0807 11	32-25	•	34	39	23	0,017	10	70

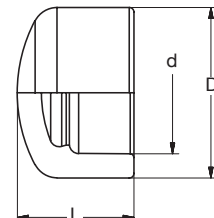

BR PP-R Kappe grün
BR PP-R Cap green

Art Nr	d	D	L	KG	VE1	VE2
Art No	[mm]	[mm]			PU1	PU2
5341 0600 11	20	29	25	0,009	10	200
5341 0700 11	25	34	28	0,013	10	100
5341 0800 11	32	43	32	0,021	10	120

3.02.04 Übergänge • Transitions

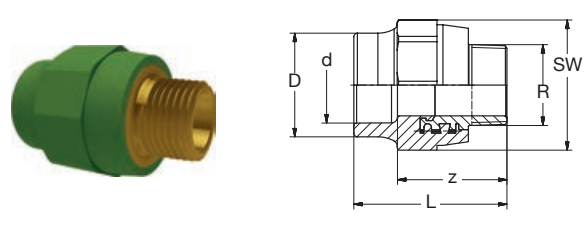
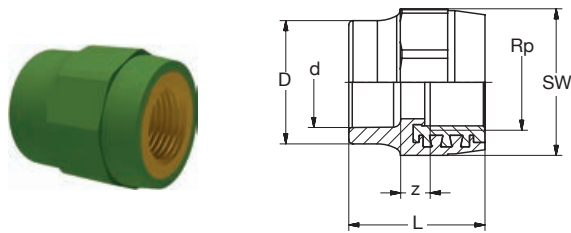

BR PP-R-RG Übergang IG-zyl grün

BR PP-R-Bronze Transition female-thread-cyl green

Art Nr Art No	d x Rp [mm x Inch]	D	L	z	SW	KG	VE1 PU1	VE2 PU2
5R11 0643 11	20 x 1/2	30	40	11	36	0,068	10	60
5R11 0645 11	20 x 3/4	29	40	11	44	0,10	10	80
5R11 0743 11	25 x 1/2	34	41	11	36	0,068	10	60
5R11 0745 11	25 x 3/4	34	41	11	44	0,10	10	40
5R11 0845 11	32 x 3/4	43	45	11	44	0,11	10	80
5R11 0846 11	32 x 1	43	48	12	51	0,15	10	50

BR PP-R-RG Übergang AG-keg grün

BR PP-R-Bronze Transition male-thread-con green

Art Nr Art No	d x R [mm x Inch]	D	L	z	SW	KG	VE1 PU1	VE2 PU2
5R11 0673 11	20 x 1/2	29	53	40	36	0,087	10	60
5R11 0675 11	20 x 3/4	34	58	42	44	0,12	10	40
5R11 0773 11	25 x 1/2	34	56	40	36	0,086	10	80
5L11 0775 11	25 x 3/4	34	58	42	44	0,12	10	70
5R11 0875 11	32 x 3/4	43	58	42	44	0,13	10	60
5R11 0876 11	32 x 1	43	66	48	51	0,19	10	40

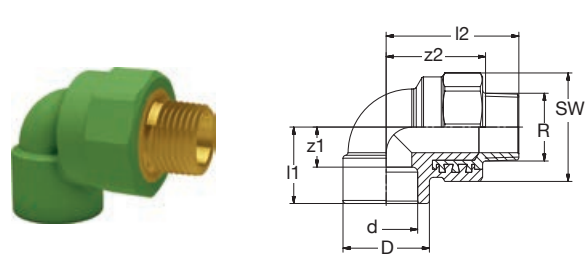
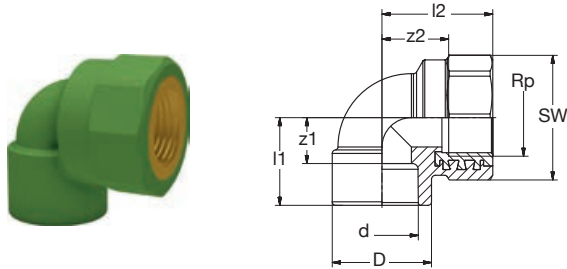

BR PP-R-RG Ü-Winkel 90° IG-zyl grün

BR PP-R-Bronze Transition-Elbow 90° female-thread-cyl green

Art Nr Art No	d x Rp [mm x Inch]	D	l1	l2	z1	z2	SW	KG	VE1 PU1	VE2 PU2
5R21 0643 11	20 x 1/2	29	28	34	14	20	36	0,075	10	80
5R21 0645 11	20 x 3/4	34	32	40	18	25	44	0,12	10	60
5R21 0743 11	25 x 1/2	34	32	36	14	24	36	0,075	10	80
5R21 0745 11	25 x 3/4	34	32	40	16	25	44	0,12	10	60
5R21 0845 11	32 x 3/4	43	38	45	20	30	44	0,13	10	40
5R21 0846 11	32 x 1	43	38	48	20	30	51	0,18	5	40

BR PP-R-RG Ü-Winkel 90° AG-keg grün

BR PP-R-Bronze Transition-Elbow 90° male-thread-con green

Art Nr Art No	d x R [mm x Inch]	D	l1	l2	z1	z2	SW	KG	VE1 PU1	VE2 PU2
5L21 0673 11	20 x 1/2	29	28	34	14	49	36	0,093	10	70
5R21 0675 11	20 x 3/4	34	32	40	18	56	44	0,14	10	40
5R21 0773 11	25 x 1/2	34	32	36	16	53	36	0,096	10	60
5R21 0775 11	25 x 3/4	34	32	40	16	56	44	0,14	10	40
5R21 0875 11	32 x 3/4	43	38	45	20	61	44	0,15	10	30
5R21 0876 11	32 x 1	43	38	48	20	66	51	0,21	10	50

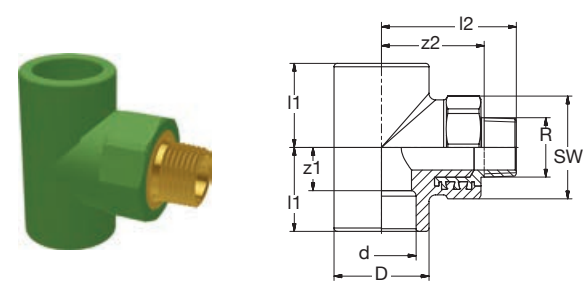
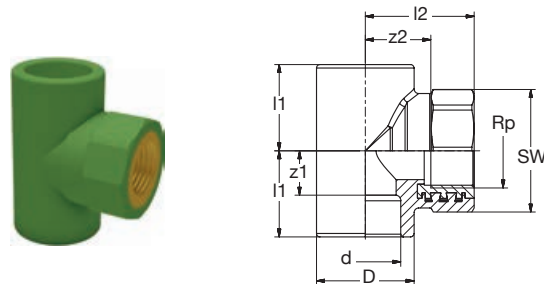

BR PP-R-RG Ü-T-Stück 90° IG-zyl grün

BR PP-R-Bronze Transition-Tee 90° female-thread-cyl green

Art Nr Art No	d x Rp [mm x Inch]	D	l1	l2	z1	z2	SW	KG	VE1 PU1	VE2 PU2
5R41 0643 11	20 x 1/2	29	28	34	14	20	36	0,080	10	60
5R41 0645 11	20 x 3/4	34	28	35	14	20	44	0,13	10	40
5R41 0743 11	25 x 1/2	34	32	38	16	24	36	0,087	10	50
5R41 0745 11	25 x 3/4	34	32	40	16	25	44	0,13	10	40
5R41 0845 11	32 x 3/4	43	38	45	20	30	44	0,15	5	30
5R41 0846 11	32 x 1	43	38	48	20	30	51	0,2	5	30

BR PP-R-RG Ü-T-Stück 90° AG-keg grün

BR PP-R-Bronze Transition-Tee 90° male-thread-con green

Art Nr Art No	d x R [mm x Inch]	D	l1	l2	z1	z2	SW	KG	VE1 PU1	VE2 PU2
5R41 0673 11	20 x 1/2	29	28	34	14	49	36	0,10	10	60
5R41 0675 11	20 x 3/4	29	28	35	14	50	44	0,15	10	70
5R41 0773 11	25 x 1/2	34	32	38	16	53	36	0,11	10	70
5R41 0775 11	25 x 3/4	34	32	40	16	55	44	0,14	10	70
5R41 0875 11	32 x 3/4	43	38	45	20	60	44	0,17	5	50
5R41 0876 11	32 x 1	43	38	48	20	66	51	0,24	10	60

3.02.05 Übergänge Wand • Transitions wall

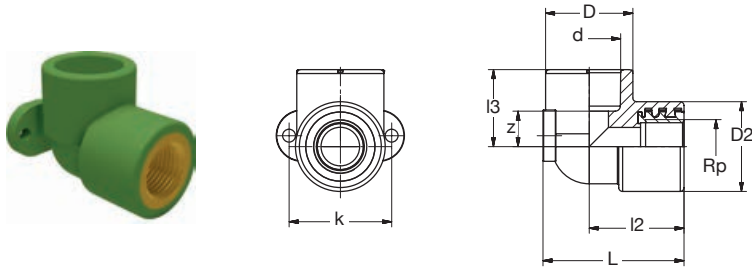

BR PP-R-RG Ü-Winkel 90° Wandbefestigung IG-zyl grün

BR PP-R-Bronze Transition-Elbow 90° wall mount female-thread-cyl green

Art Nr	d x Rp	D	D2	L	I2	I3	k	z	KG	VE1	VE2
Art No	[mm x Inch]	[mm]								PU1	PU2
5R31 0643 11	20 x 1/2	35	29	50	35	27	40	21	0,077	10	40
5R31 0743 11	25 x 1/2	35	34	54	37	30	40	23	0,14	10	60
5R31 0745 11	25 x 3/4	43	43	65	43	35	50	28	0,14	10	30
5R31 0845 11	32 x 3/4	43	43	65	43	35	50	28	0,14	10	30

3.02.06 Verschraubungen • Unions

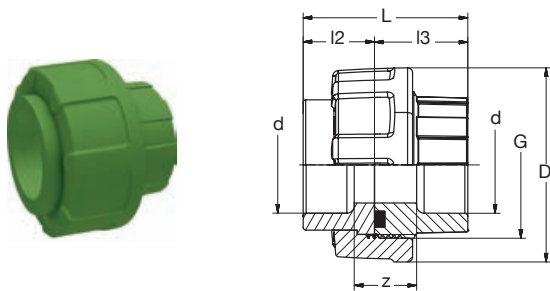

BR PP-R Verschraubung Runddichtring-EPDM 20°C/ 1,0MPa grün

BR PP-R Union O-Ring-gasket-EPDM 20°C/ 1.0MPa green

Art Nr	d	D	G	L	I2	I3	z	KG	VE1	VE2
Art No	[mm]	[mm]	[Zoll/Inch]	[mm]					PU1	PU2
5351 0600 31	20	46	1	44,0	17,5	26	15	0,039	1	150
5351 0700 31	25	56	1 1/4	47,5	19,0	28	15	0,061	1	125
5351 0800 31	32	66	1 1/2	51,5	21,0	30	15	0,091	1	100

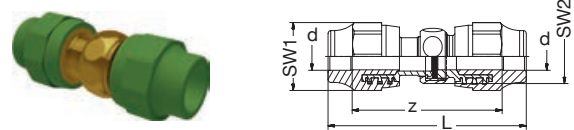

BR PP-R-RG Verschraubung Flachdichtring-EPDM grün

BR PP-R-Bronze Union flat-gasket-EPDM green

Art Nr	d	L	z	SW1	SW2	KG	VE1	VE2
Art No	[mm]	[mm]					PU1	PU2
5R51 0600 11	20	116	87	44	37	0,25	1	50
5R51 0700 11	25	119	87	44	37	0,39	1	30
5R51 0800 11	32	134	96	51	46	0,58	1	20

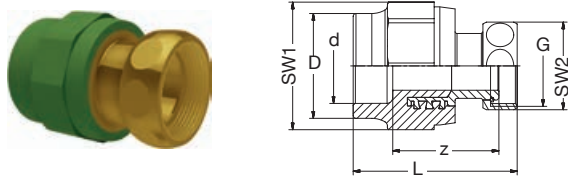

BR PP-R-RG Anschlussverschraubung für Armaturen + Wasserzähler IG-zyl mit Flachdichtring-EPDM grün

BR PP-R-Bronze Union flat- sealing for Valves + Water meters female-thread-cyl with flat-gasket-EPDM green

Art Nr	d x G	D	L	z	SW1	SW2	KG	VE1	VE2	
Art No	[mm x Inch]	[mm]							PU1	PU2
5R51 06A0 11	20 x 3/4	29	66	44	36	30	0,14	1	50	
5R51 06A1 11	20 x 1	29	72	44	44	37	0,23	1	30	
5R51 07A0 11	25 x 3/4	34	67	44	44	30	0,13	1	50	
5R51 07A1 11	25 x 1	34	72	47	44	37	0,20	1	30	
5R51 08A0 11	32 x 1	43	80	53	51	37	0,19	1	20	
5R51 08A1 11	32 x 1 1/4	43	80	53	51	46	0,32	1	20	

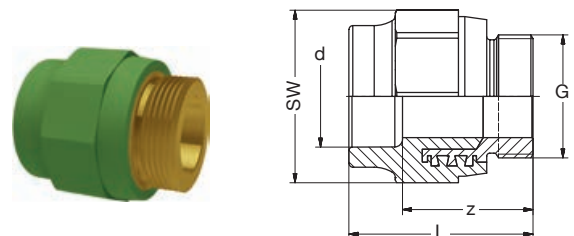

BR PP-R-RG Verschraubung Schraubteil flachdichtend grün

BR PP-R-Bronze Union Srew-part flat-sealing green

Art Nr	d x G	L	z	SW	KG	VE1	VE2
Art No	[mm x Inch]	[mm]				PU1	PU2
5R51 06S0 11	20 x 3/4	50	34	36	0,11	1	50
5R51 06S1 11	20 x 1	53	38	44	0,14	1	30
5R51 07S0 11	25 x 3/4	51	35	36	0,11	1	30
5R51 07S1 11	25 x 1	54	38	44	0,14	1	30
5R51 08S1 11	32 x 1 1/4	62	43	51	0,45	1	20

3.02.06 Verschraubungen • Unions

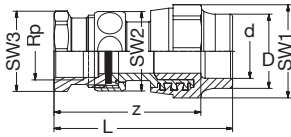

BR PP-R-RG Ü-Verschraubung IG-zyl Flachdichtring-EPDM grün

BR PP-R-Bronze Transition-Union female-thread-cyl flat-gasket-EPDM green

Art Nr	d x Rp	G	D	L	z	SW1	SW2	SW3	KG	VE1	VE2
Art No	[mm x Inch]	[Inch]	[mm]							PU1	PU2
5R51 0643 11	20 x 1/2	3/4	29	85	70	36	30	27	0,19	1	50
5R51 0645 11	20 x 3/4	1	29	93	78	44	37	34	0,34	1	30
5R51 0743 11	25 x 1/2	3/4	34	87	71	36	30	27	0,19	1	50
5R51 0745 11	25 x 3/4	1	34	95	79	44	37	34	0,30	1	30
5R51 0845 11	32 x 3/4	1	43	97	79	44	37	34	0,34	1	20
5R51 0846 11	32 x 1	1 1/4	43	103	85	51	46	44	0,51	1	20

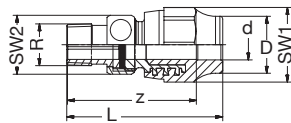

BR PP-R-RG Übergangs-Verschraubung AG-keg Flachdichtring-EPDM grün

BR PP-R-Bronze Transition-Union male-thread-con flat-gasket-EPDM green

Art Nr	d x R	G	D	L	z	SW1	SW2	KG	VE1	VE2	
Art No	[mm x Inch]	[Inch]	[mm]							PU1	PU2
5R51 0673 11	20 x 1/2	3/4	29	79	65	36	30	0,18	1	50	
5R51 0675 11	20 x 3/4	1	29	86	72	44	37	0,28	1	30	
5R51 0773 11	25 x 1/2	3/4	34	81	65	36	30	0,16	1	50	
5R51 0775 11	25 x 3/4	1	34	88	72	44	37	0,27	1	30	
5R51 0875 11	32 x 3/4	1	43	81	63	44	37	0,29	1	20	
5R51 0876 11	32 x 1	1 1/4	43	98	80	51	46	0,42	1	20	

3.02.07 Kugelhähne • Ball valves

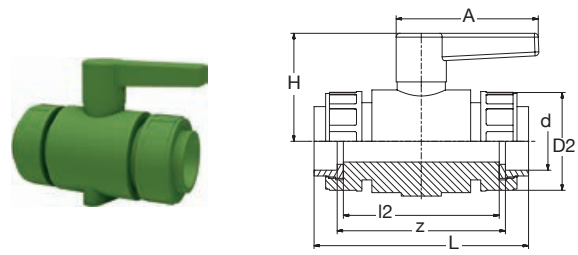
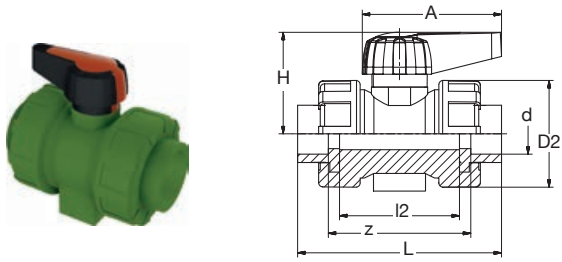

BR PP-R Kugelhahn verschraubt 20°C/1,0MPa grün
BR PP-R Ball valve with union-nuts 20°C/1.0MPa green

BR PP-R Kugelhahn verschraubt Runddichtring-EPDM 20°C/1,0MPa grün
BR PP-R Ball valve with union-nuts O-Ring gasket EPDM 20°C/1.0MPa green

Art Nr	d	D2	L	l2	H	A	z	KG	VE1	VE2
Art No	[mm]			[mm]					PU1	PU2
591V 0600 21	20	50,5	96	56,5	48	66,5	67	0,12	1	-
591V 0700 21	25	59	109	65	57	81,5	77	0,19	1	-
591V 0800 21	32	70,5	119	71	65	81,5	83	0,28	1	-
591V 0900 21	40	86	141	85,5	83,5	91,5	100	0,44	1	-
591V 1000 21	50	99,5	153	89	89,5	91,5	106	0,54	1	-
591V 1100 21	63	126	172	101	115	143	117	0,93	1	-

Art Nr	d	D2	L	l2	H	A	z	KG	VE1	VE2
Art No	[mm]			[mm]					PU1	PU2
591V 1200 21	75	128,0	275	205	137	186	213	2,57	1	4

Kein Lagerartikel • Not a stock item

mit Runddichtring-EPDM und PTFE-Kugelabdichtung.
with O-Ring-gasket-EPDM and PTFE-Ball-valve-sealing.

Weitere Dimensionen und Modelle siehe Kapitel RCT.
Other dimensions and models see chapter RCT.

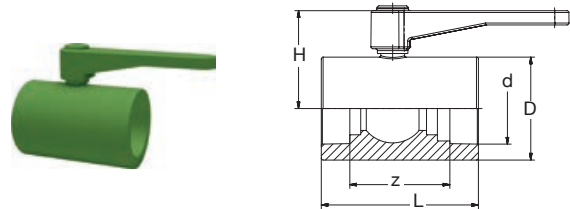

BR PP-R Kugelhahn grün
BR PP-R Ball valve green

Art Nr	d	D	L	H	z	KG	VE1	VE2
Art No	[mm]		[mm]				PU1	PU2
5911 1200 21	75	108	166	98	106	1,90	1	-

3.02.08 Ventile • Valves

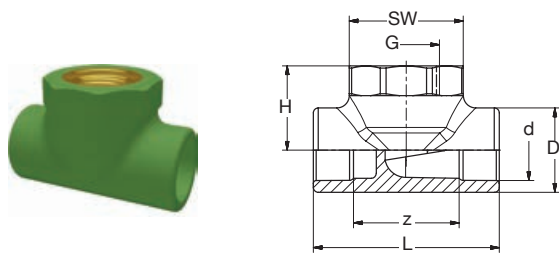

BR PP-R-RG Ventil Geradsitz Unterteil IG-zyl grün
BR PP-R-Bronze Valve straight bottom part female-thread-cyl green

Art Nr	d x G	D	L	H	z	SW	KG	VE1	VE2
Art No	[mm]	[mm]						PU1	PU2
5RG1 06U0 11	20 x 3/4	29	75	34	46	46	0,110	10	80
5RG1 07U0 11	25 x 3/4	34	75	34	43	46	0,117	10	60
5RG1 08U0 11	32 x 3/4	43	75	34	38	46	0,134	10	80

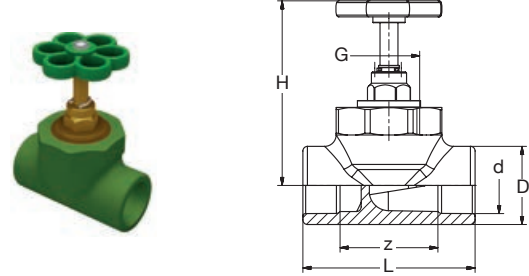

BR PP-R-RG Ventil Geradsitz mit Handrad grün
BR PP-R-Bronze Valve straight concealed with hand wheel green

Art Nr	d	D	L	H	z	KG	VE1
Art No	[mm]	[mm]					PU1
5RG1 060H 11	20	29	75	69	46	0,29	1
5RG1 070H 11	25	34	75	69	43	0,29	1
5RG1 080H 11	32	43	75	69	39	0,32	1

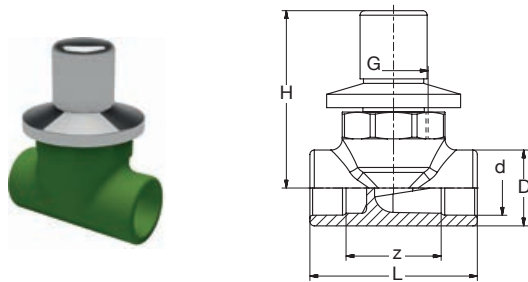

BR PP-R-RG Ventil Geradsitz UP mit Flügelrad + Kappe grün
BR PP-R-Bronze Valve straight concealed winged wheel + cap green

Art Nr	d	D	L	H	z	KG	VE1
Art No	[mm]	[mm]					PU1
5RG1 060K 11	20	29	75	63	46	0,286	1
5RG1 070K 11	25	34	75	63	43	0,275	1
5RG1 080K 11	32	43	75	63	38	0,298	1

Mit verchromter Rosette 70 mm.
With chromed rosette 70 mm.

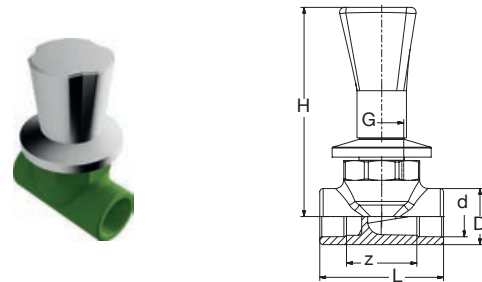

BR PP-R-RG Ventil Geradsitz UP Drehgriff grün
BR PP-R-Bronze Valve straight concealed handle bar green

Art Nr	d	D	L	H	z	KG	VE1
Art No	[mm]	[mm]					PU1
5RG1 060G 11	20	34	75	112	46	0,330	1
5RG1 070G 11	25	34	75	112	43	0,332	1
5RG1 080G 11	32	43	75	112	38	0,320	1

Mit verchromter Rosette 70 mm.
With chromed rosette 70 mm.

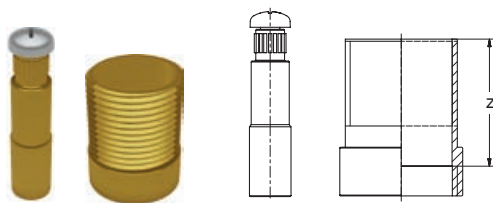

BR Ventil Geradsitz UP Verlängerungsset 30mm
BR Valve straight concealed prolongation-set 30mm

Art Nr	L	KG	VE1
Art No	[mm]		PU1
9902 0004 09	30	0,15	1

Bestehend aus: Gewindehülse, Achsverlängerung und Schraube.
Consists of: threaded sleeve, axle extension and screw.

4 PP-RCT

PP-RCT ist eine neue Polypropylen-Werkstoffgeneration. Dank Ihrer Struktur können Rohre und Formteile mit höherer hydraulischer Kapazität oder mit höherer Druckbelastbarkeit hergestellt werden. Das heißt, stellt man – für den gleichen Einsatzfall – die Rohre dünnwandiger her, haben sie bei gleichbleibendem Außendurchmesser eine höhere Durchflussleistung.

Bei der Konzeption der Rohrsysteme kann somit der Außendurchmesser bei fast gleichem Innendurchmesser um eine Dimension reduziert werden.

Die Druckbelastbarkeit von PP-RCT ist deutlich höher als bei PP-R; z.B. ist bei einer Anwendungstemperatur von 70°C ein bis zu 60% höherer Druck möglich.

Eigenschaften

- Hohe chemische Beständigkeit
- Korrosionsbeständigkeit
- Hervorragende Verarbeitbarkeit

Werkstoff

PP-RCT (Polypropylen - Random-Copolymer, Crystalline structure, Temperature resistant) mit modifizierter Kristallstruktur (beta nukleiert) und erhöhter Temperaturbeständigkeit, RAL 6024 Verkehrsgrün.

Verbindungstechnik

- Heizelement-Muffen-Schweißung
- Heizelement-Stumpf-Schweißung
- Heizwendel-Muffen-Schweißung
- Flanschverbindung

PP-RCT is a new generation of Polypropylene material. Thanks to its structure, pipes and fittings can be produced with higher hydraulic capacity or with higher compressive strength. This means that – for the same application case – if the pipes are produced with thinner walls, they have higher flow capacity with a consistent diameter. With the conception of the pipe systems, the outer diameter can therefore be reduced by one dimension with virtually the same inner diameter.

The compressive strength of PP-RCT is significantly higher than with PP-R; e.g. with an application temperature of 70°C higher pressure of up to 60% is possible.

Properties:

- Good resistance to chemicals
- Corrosion resistance
- Excellent processing capability

Material:

PP-RCT (Polypropylene - Random-Copolymer, Crystalline structure, Temperature resistant) with a modified crystal structure (beta nucleated) and increased temperature resistance, RAL 6024 traffic green.

Joining technology:

- Socket-welding
- Butt-welding
- Electrofusion socket-welding
- Flange connection



4.01 Rohre • Pipes RCT 3

4.01.01 Rohre einlagig
Pipes single-layer RCT 3



4.01.02 Rohre mehrlagig
Pipes multi-layer RCT 6



4.01.03 Sonderrohre
Special Pipes RCT 10

**4.02 Formteile Muffen-Schweißen
Fittings socket-welding RCT 12**

4.02.01 Bögen, Winkel
Bends, Elbows RCT 12

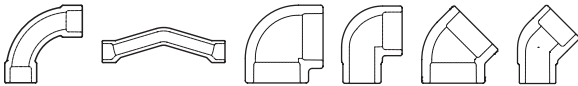

4.02.02 T-Stücke, Abzweige
Tee's, Branches RCT 14

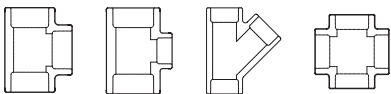

4.02.03 Reduktionen, Muffen, Kappen
Reducers, Sockets, Caps RCT 16

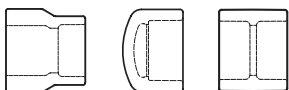

4.02.04 Übergänge
Transitions RCT 17



4.02.05 Übergänge Wand
Transitions wall RCT 20



4.02.06 Verschraubungen
Unions RCT 22

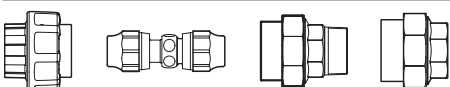

4.02.07 Flanschverbindung
Flange connection RCT 25

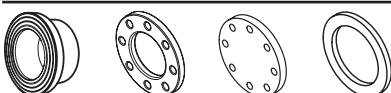

4.02.08 Einschweißsättel
Weld-in-saddles RCT 26

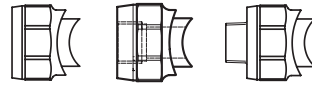

4.02.09 Verteiler
Manifolds RCT 29



4.02.10 Kugelhähne
Ball valves RCT 30

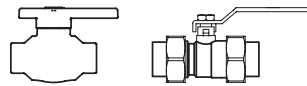

4.02.11 Ventile
Valves RCT 31

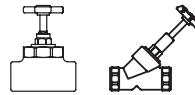

**4.03 Formteile Stumpf-Schweißen
Fittings butt-welding RCT 33**

4.03.01 Winkel
Elbows RCT 33

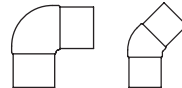

4.03.02 T-Stücke
Tee's RCT 34

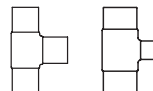

4.03.03 Reduktionen, Kappen
Reducers, Caps RCT 34

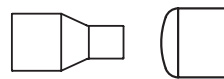

4.03.04 Flanschverbindung
Flange connection RCT 36



**4.04 Formteile Heizwendel-Muffen-Schweißen
Fittings electrofusion-socket-welding RCT 38**



4.01.01 Rohre einlagig • Pipes single-layer

POWERTEC-CT

Beschreibung

PP-RCT Druckrohr POWERTEC-CT, einschichtig, SDR7,4. Homogenes Rohr für sehr hohe Drücke und hohe Temperaturen.

Werkstoff

PP-RCT (Polypropylen - Random copolymer, Crystalline structure, Temperature resistant) mit modifizierter Kristallstruktur (beta nukleiert) und erhöhter Temperaturbeständigkeit, Borealis RA7050GN, Farbe RAL 6024 Verkehrsgrün.

Das Material entspricht den Anforderungen der aktuellen KTW-Leitlinie des Umweltbundesamtes (UBA).

Geometrische Eigenschaften

Abmessungen und Toleranzen entsprechend DIN 8077 und DIN EN ISO 15874-2.

Betriebsdruck

20°C/2,0 MPa • 70°C/1,0 MPa.

Ausführung

Geeignet für Heizelement-Muffen-Schweißung, Heizelement-Stumpf-Schweißung und Heizwendel-Muffen-Schweißung nach DVS Richtlinie 2207. Schweiß-Geräte und Schweiß-Werkzeuge sollten der DVS Richtlinie 2208 entsprechen.

Zertifizierung

B-R Rohre unterliegen regelmäßigen internen und externen Qualitätskontrollen. Die Rohre erfüllen die Anforderungen der DIN Certco Richtlinie ZP 10.25.1, NSF14 + 61, AENOR und ÖVGW.

Lieferung

In 4 m Stangen; abgepackt in Bunden, bzw. D125 einzelnverpackt. Alle Bunde sind in schwarzer UV-Schutz-Schlauchfolie verpackt. Abgabe erfolgt nur in kompletten Verpackungseinheiten (VEs).

Description

PP-RCT Pressure pipe POWERTEC-CT, single-layer, SDR7,4. Homogeneous pipe for very high pressures and high temperatures.

Material

PP-RCT (Polypropylene - Random copolymer, Crystalline structure, Temperature resistant) with modified crystalline structure (beta nucleated) and increased temperature resistance, Borealis RA7050GN, colour RAL 6024 traffic green.

The material complies with the requirements of the KTW guideline of the German Federal Environmental Agency (UBA).

Geometric Properties

Dimensions and tolerances according to DIN 8077 and DIN EN ISO 15874-2.

Operating Pressure

20°C/2.0 MPa • 70°C/1.0 MPa.

Type

Suitable for socket-welding, butt-welding and electrofusion-socket-welding according to DVS technical code 2207. Welding equipment according to DVS technical code 2208.

Certification

B-R pipes succumb frequent internal and external quality controls. The pipes fulfill the requirements of the DIN Certco guideline ZP 10.25.1 and NSF14 + 61, AENOR and ÖVGW.

Delivery

In 4 m rods; packed in bundles or D125 individually packed. All bundles are packed in black UV-protection-foil. Supply only in complete packing units (PU's).

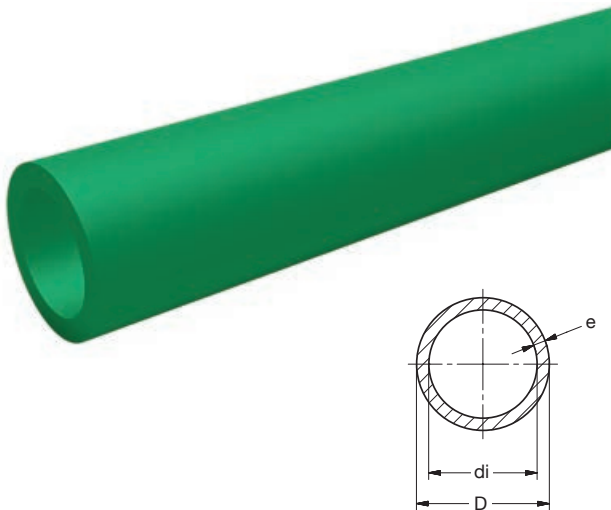

BR PP-RCT Druckrohr **POWERTEC-CT** 2,0MPa **SDR7,4** grün

BR PP-RCT Pressure-Pipe **POWERTEC-CT** 2.0 MPa **SDR7,4** green

Art Nr	D	e	DN	di	SDR	L	KG	VE1	VE2
Art No	[mm]		[mm]	[mm]		[m]		PU1	PU2
20°C / 2,0 MPa • 70°C / 1,0 MPa									
7112 0640 11	20	2,8	15	14,4	7,4	4	0,18	100	3500
7112 0740 11	25	3,5	20	18,0	7,4	4	0,28	100	2300
7112 0840 11	32	4,4	25	23,2	7,4	4	0,46	60	1200
7112 0940 11	40	5,5	32	29,0	7,4	4	0,68	40	840
7112 1040 11	50	6,9	40	36,2	7,4	4	1,09	20	600
7112 1140 11	63	8,6	50	45,8	7,4	4	1,40	20	400
7112 1240 11	75	10,3	-	54,4	7,4	4	1,96	8	256
7112 1340 11	90	12,3	65	65,4	7,4	4	2,94	8	176
7112 1440 11	110	15,1	80	79,8	7,4	4	4,36	8	120
7112 1540 11	125	17,1	90	90,8	7,4	4	5,56	4	100
7112 1740 11	160 *	21,9	100	116,2	7,4	4	9,02	4	48
7112 1940 11	200 *	27,4	125	145,2	7,4	4	13	4	36

* Kein Lagerartikel / Not a stock item.

ECONTEC-CT

Beschreibung

PP-RCT Druckrohr ECONTEC-CT, einschichtig, SDR9 bis 11. Homogenes Rohr für hohe Drücke und hohe Temperaturen, bei gleichzeitigem hohen Durchfluss.

Werkstoff

PP-RCT (Polypropylen - Random copolymer, Crystalline structure, Temperature resistant) mit modifizierter Kristallstruktur (beta nukleiert) und erhöhter Temperaturbeständigkeit, Borealis RA7050GN, Farbe RAL 6024 Verkehrsgrün.

Das Material entspricht den Anforderungen der aktuellen KTW-Leitlinie des Umweltbundesamtes (UBA).

Geometrische Eigenschaften

Abmessungen und Toleranzen entsprechend DIN 8077 und DIN EN ISO 15874-2.

Betriebsdruck

20°C/1,6 MPa • 60°C/0,8 MPa.

Ausführung

Geeignet für Heizelement-Muffen-Schweißung, Heizelement-Stumpf-Schweißung und Heizwendel-Muffen-Schweißung nach DVS Richtlinie 2207. Schweiß-Geräte und Schweiß-Werkzeuge sollten der DVS Richtlinie 2208 entsprechen.

Zertifizierung

B-R Rohre unterliegen regelmäßigen internen und externen Qualitätskontrollen. Die Rohre erfüllen die Anforderungen der DIN Certco Richtlinie ZP 10.25.1.

Lieferung

Bis D200 in 4 m Stangen und ab D250 in 5,8 m Stangen; abgepackt in Bunden, bzw. ab D125 einzelverpackt. Alle Rohre/Bunde sind in schwarzer UV-Schutz-Schlauchfolie verpackt. Abgabe erfolgt nur in kompletten Verpackungseinheiten (VE's).

Description

PP-RCT Pressure pipe ECONTEC-CT, single-layer, SDR9 up to 11. Homogeneous pipe for high pressures and high temperatures with simultaneous high flow.

Material

PP-RCT (Polypropylene - Random copolymer, Crystalline structure, Temperature resistant) with modified crystalline structure (beta nucleated) and increased temperature resistance, Borealis RA7050GN, colour RAL 6024 traffic green.

The material complies with the requirements of the KTW guideline of the German Federal Environmental Agency (UBA).

Geometric Properties

Dimensions and tolerances according to DIN 8077 and DIN EN ISO 15874-2.

Operating Pressure

20°C/1.6 MPa • 60°C/0.8 MPa.

Type

Suitable for socket-welding, butt-welding and electrofusion-socket-welding according to DVS technical code 2207. Welding equipment according to DVS technical code 2208.

Certification

B-R pipes succumb frequent internal and external quality controls. The pipes fulfill the requirements of the DIN Certco guideline ZP 10.25.1.

Delivery

Up to D200 in 4 m rods and from D250 in 5.8 m rods; packed in bundles or from D125 and above individually packed. All pipes/bundles are packed in black UV-protection-foil. Supply only in complete packing units (PU's).

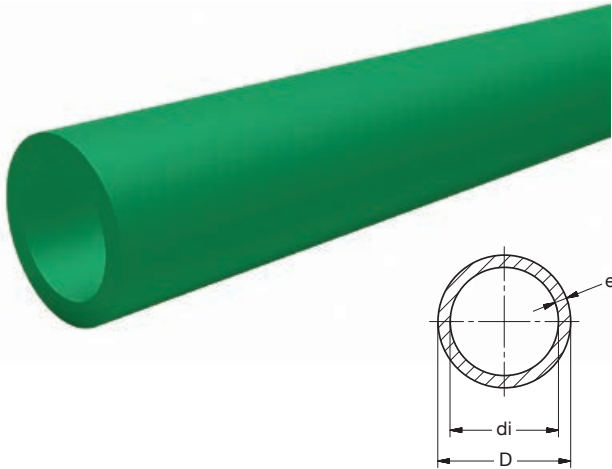

BR PP-RCT Druckrohr **ECONTEC-CT** 1,6MPa grün

BR PP-RCT Pressure-Pipe **ECONTEC-CT** 1.6Mpa green

Art Nr	D	e	DN	di	SDR	L	KG	VE1	VE2
Art No	[mm]		[mm]	[mm]		[m]		PU1	PU2
20°C / 1,6 MPa • 60°C / 0,8 MPa									
7113 0640 11	20	2,3	15	15,4	9	4	0,14	100	3500
7113 0740 11	25	2,8	20	19,4	9	4	0,21	100	2300
7114 0840 11	32	2,9	25	26,2	11	4	0,29	60	1200
7114 0940 11	40	3,7	32	32,6	11	4	0,42	40	840
7114 1040 11	50	4,6	40	40,8	11	4	0,64	20	600
7114 1140 11	63	5,8	50	51,4	11	4	1,40	20	400
7114 1240 11	75	6,8	-	61,4	11	4	1,44	8	256
7114 1340 11	90	8,2	65	73,6	11	4	1,03	8	176
7114 1440 11	110	10	80	90	11	4	3,08	8	120
7114 1540 11	125	11,4	100	102,2	11	4	3,91	4	100
7114 1740 11	160	14,6	125	130,8	11	4	6,33	4	48
7114 1940 11	200	18,2	160	163,6	11	4	9,95	4	36
7114 2158 11	250	22,7	200	204,6	11	5,8	15,3	5,8	29
7114 2358 11	315	28,6	250	257,8	11	5,8	24,6	5,8	11,6
7114 2458 11	355	32,2	300	290,6	11	5,8	31,2	5,8	11,6
7114 2558 11	400	36,3	-	327,4	11	5,8	39,6	5,8	-
7114 2658 11	450	40,9	350	368,2	11	5,8	50,1	5,8	-
7114 2758 11	500	45,4	400	409,2	11	5,8	61,7	5,8	-

CYCLETEC-CT

Beschreibung

PP-RCT Druckrohr CYCLETEC-CT, einschichtig mit äußerer Deckschicht in lila, SDR9 bis 11. Homogenes Rohr für hohe Drücke und hohe Temperaturen, bei gleichzeitigem hohen Durchfluss.

Spezielle Farbe und Beschriftung zur Identifikation der Leitung als Nicht-Trinkwasser. Für Anwendungen mit z.B. Regen-, regeneriertem oder wiederverwendetem Wasser zur Reinigung, Spülung, Waschen oder zur Bewässerung.

Werkstoff

PP-RCT (Polypropylen - Random copolymer, Crystalline structure, Temperature resistant) mit modifizierter Kristallstruktur (beta nukleiert) und erhöhter Temperaturbeständigkeit, Borealis RA7050GN, Farbe RAL 6024 Verkehrsgrün.

Das Material entspricht den Anforderungen der aktuellen KTW-Leitlinie des Umweltbundesamtes (UBA). Äußere Deckschicht aus PP-R in lila.

Geometrische Eigenschaften

Abmessungen und Toleranzen entsprechend DIN 8077 und DIN EN ISO 15874-2.

Betriebsdruck

20°C/1,6 MPa • 60°C/0,8 MPa.

Ausführung

Geeignet für Heizelement-Muffen-Schweißung, Heizelement-Stumpf-Schweißung und Heizwendel-Muffen-Schweißung nach DVS Richtlinie 2207. Schweiß-Geräte und Schweiß-Werkzeuge sollten der DVS Richtlinie 2208 entsprechen.

Zertifizierung

B-R Rohre unterliegen regelmäßigen internen und externen Qualitätskontrollen.

Lieferung

In 4 m Stangen; abgepackt in Bündeln, bzw. D125 einzeln verpackt. Alle Rohre/Bündel sind in schwarzer UV-Schutz-Schlauchfolie verpackt. Abgabe erfolgt nur in kompletten Verpackungseinheiten (VEs).

Description

PP-RCT Pressure pipe CYCLETEC-CT, single-layer with outer layer in lilac, SDR9 up to 11. Homogeneous pipe for high pressures and high temperatures with simultaneous high flow.

Colour-coded and labeled to identify it as a non-potable line. For applications like rain, recycled or reclaimed water for cleaning, flush, laundry or irrigation.

Material

PP-RCT (Polypropylene - Random copolymer, Crystalline structure, Temperature resistant) with modified crystalline structure (beta nucleated) and increased temperature resistance, Borealis RA7050GN, colour RAL 6024 traffic green.

The material complies with the requirements of the KTW guideline of the German Federal Environmental Agency (UBA). Outer layer made of PP-R in lilac colour.

Geometric Properties

Dimensions and tolerances according to DIN 8077 and DIN EN ISO 15874-2.

Operating Pressure

20°C/1.6 MPa • 60°C/0.8 MPa.

Type

Suitable for socket-welding, butt-welding and electrofusion-socket-welding according to DVS technical code 2207. Welding equipment according to DVS technical code 2208.

Certification

B-R pipes succumb frequent internal and external quality controls.

Delivery

In 4 m rods; packed in bundles or D125 individually packed. All pipes/bundles are packed in black UV-protection-foil. Supply only in complete packing units (PU's).

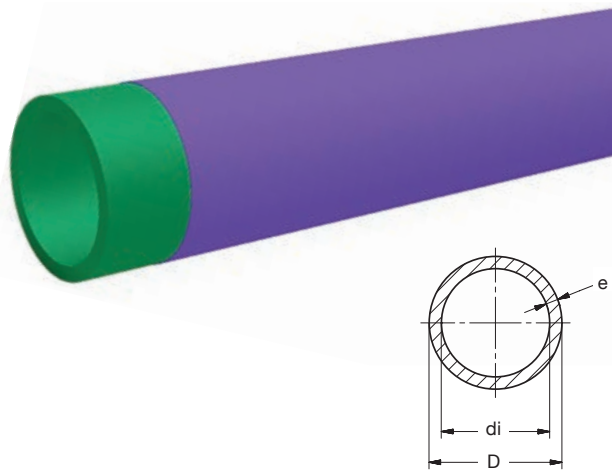

BR PP-RCT Druckrohr **CYCLETEC-CT** 1,6MPa lila 4m

BR PP-RCT Pressure-Pipe **CYCLETEC-CT** 1.6MPa lilac 4m

Art Nr	D	e	DN	di	SDR	L	KG	VE1	VE2
Art No	[mm]		[mm]	[mm]		[m]		PU1	PU2
20°C / 1,6 MPa • 60°C / 0,8 MPa									
7123 0640 17	20	2,3	15	15,4	9	4	0,14	100	3500
7123 0740 17	25	2,8	20	19,4	9	4	0,21	100	2300
7124 0840 17	32	2,9	25	26,2	11	4	0,29	60	1200
7124 0940 17	40	3,7	32	32,6	11	4	0,42	40	840
7124 1040 17	50	4,6	40	40,8	11	4	0,64	20	600
7124 1140 17	63	5,8	50	51,4	11	4	1,40	20	400
7124 1240 17	75	6,8	-	61,4	11	4	1,44	8	256
7124 1340 17	90	8,2	65	73,6	11	4	2,03	8	176
7124 1440 17	110	10,0	80	90	11	4	3,08	8	120
7124 1540 17	125	11,4	100	102,2	11	4	3,91	4	100

STABITEC-CT OT

Beschreibung

PP-RCT Druckrohr STABITEC-CT OT, mehrlagig, mit äußerer Aluminium Deckschicht zur Reduzierung der axialen Ausdehnung, SDR7,4 bis 9. Sauerstoffdicht nach DIN 4726.

Homogenes Rohr für hohe Drücke und hohe Temperaturen, bei gleichzeitigem hohem Durchfluss und stark reduzierter Längenausdehnung. Vor dem Schweißen muss die Aluminiumschicht entfernt werden.

Werkstoff

PP-RCT (Polypropylen - Random copolymer, Crystalline structure, Temperatureresistent) mit modifizierter Kristallstruktur (beta nukleiert) und erhöhter Temperaturbeständigkeit, Borealis RA7050GN, Farbe RAL 6024 Verkehrsgrün.

Das Material entspricht den Anforderungen der aktuellen KTW-Leitlinie des Umweltbundesamtes (UBA). Äußere PP-RCT-Schutz-Deckschicht in grün.

Geometrische Eigenschaften

Abmessungen und Toleranzen des Innenrohres entsprechend DIN 8077 und DIN EN ISO 15874-2.

Betriebsdruck

20°C/2,0 MPa • 70°C/1,0 MPa.

Ausführung

Geeignet für Heizelement-Muffen-Schweißung, Heizelement-Stumpf-Schweißung und Heizwendel-Muffen-Schweißung nach DVS Richtlinie 2207. Schweiß-Geräte und Schweiß-Werkzeuge sollten der DVS Richtlinie 2208 entsprechen.

Zertifizierung

B-R Rohre unterliegen regelmäßigen internen und externen Qualitätskontrollen. Die Rohre erfüllen die Anforderungen der DIN Certco Richtlinie ZP 9.18.1.

Lieferung

In 4 m Stangen; abgepackt in Bunden, bzw. D125 einzelverpackt. Alle Bunde sind in schwarzer UV-Schutz-Schlauchfolie verpackt. Abgabe erfolgt nur in kompletten Verpackungseinheiten (VE's).

Description

PP-RCT Pressure pipe STABITEC-CT OT, multi-layer, with outer Aluminium-layer for reduced axial expansion, SDR7,4 up to 9. Oxygen-tight according to DIN 4726.

Homogeneous pipe for high pressures and high temperatures, with simultaneous high flow and highly reduced expansion. The Aluminium-layer must be removed prior to welding.

Material

PP-RCT (Polypropylene - Random copolymer, Crystalline structure, Temperature resistant) with modified crystalline structure (beta nucleated) and increased temperature resistance, Borealis RA7050GN, colour RAL 6024 traffic green.

The material complies with the requirements of the KTW guideline of the German Federal Environmental Agency (UBA). Outer PP-RCT-protection-layer in green colour.

Geometric Properties

Dimensions and tolerances of the inner pipe according to DIN 8077 and DIN EN ISO 15874-2.

Operating Pressure

20°C/2.0 MPa • 70°C/1.0 MPa.

Type

Suitable for socket-welding, butt-welding and electrofusion-socket-welding according to DVS technical code 2207. Welding equipment according to DVS technical code 2208.

Certification

B-R pipes succumb frequent internal and external quality controls. The pipes fulfill the requirements of the DIN Certco guideline ZP 9.18.1.

Delivery

In 4 m rods; packed in bundles or D125 individually packed. All bundles are packed in black UV-protection-foil. Supply only in complete packing units (PU's).

**NEW VERSION
OXYGEN-TIGHT**

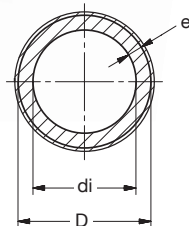

BR PP-RCT-Alu Druckrohr **STABITEC-CT OT** 2,0MPa grün 4m

BR PP-RCT-Alu Pressure-Pipe **STABITEC-CT OT** 2.0MPa green 4m

Art Nr	D	e	DN	di	SDR	L	KG	VE1	VE2
Art No	[mm]		[mm]	[mm]		[m]		PU1	PU2
20°C / 2,0 MPa • 70°C / 1,0 MPa									
71S2 0640 11	20	2,8	15	14,4	7,4	4	0,22	100	2500
71S3 0740 11	25	2,8	20	19,4	9	4	0,29	100	2000
71S3 0840 11	32	3,6	25	24,8	9	4	0,55	60	1200
71S3 0940 11	40	4,5	32	31,0	9	4	0,64	40	800
71S3 1040 11	50	5,6	40	38,8	9	4	0,94	20	600
71S3 1140 11	63	7,1	50	48,8	9	4	1,47	20	340
71S3 1240 11	75	8,4	-	58,2	9	4	1,93	8	256
71S3 1340 11	90	10,1	65	69,8	9	4	3,01	8	168
71S3 1440 11	110	12,3	80	85,4	9	4	4,29	8	120
71S3 1540 11	125	14,0	100	97,0	9	4	5,28	4	100

WATERTEC

Beschreibung

PP-RCT Druckrohr WATERTEC, mehrlagig, mit Faser-Mittelschicht zur Reduzierung der axialen Ausdehnung, SDR7,4 bis 11.

Für hohe Drücke und hohe Temperaturen, bei gleichzeitigem hohem Durchfluss und reduzierter Längenausdehnung.

Faser-Rohre können, analog zu Vollwand-Rohren, ohne vorherigen Bearbeitungsschritt direkt verschweißt werden.

Werkstoff

PP-RCT (Polypropylen - Random copolymer, Crystalline structure, Temperature resistant) mit modifizierter Kristallstruktur (beta nukleiert) und erhöhter Temperaturbeständigkeit, Borealis RA7050GN, Farbe RAL 6024 Verkehrsgrün. Das Material entspricht den Anforderungen der aktuellen KTW-Leitlinie des Umweltbundesamtes (UBA).

Geometrische Eigenschaften

Abmessungen und Toleranzen entsprechend DIN 8077 und DIN EN ISO 15874-2.

Betriebsdruck

Bis D125 = 20°C/2,0 MPa • 70°C/1,0 MPa.

Ab D160 = 20°C/1,6 MPa • 70°C/0,8 MPa.

Ausführung

Geeignet für Heizelement-Muffen-Schweißung, Heizelement-Stumpf-Schweißung und Heizwendel-Muffen-Schweißung nach DVS Richtlinie 2207. Schweiß-Geräte und Schweiß-Werkzeuge sollten der DVS Richtlinie 2208 entsprechen.

Zertifizierung

B-R Rohre unterliegen regelmäßigen internen und externen Qualitätskontrollen. Die Rohre erfüllen die Anforderungen der DIN Certco Richtlinie ZP 9.12.1 und NSF14 + 61.

Lieferung

Bis D200 in 4 m Stangen und ab D250 in 5,8 m Stangen; abgepackt in Bunden, bzw. ab D125 einzeln verpackt. Alle Rohre/Bunde sind in schwarzer UV-Schutz-Schlauchfolie verpackt. Abgabe erfolgt nur in kompletten Verpackungseinheiten (VE's).

Description

PP-RCT Pressure pipe WATERTEC, multi-layer, with fiber-middle-layer for reduced axial expansion, SDR7,4 up to 11.

For high pressures and high temperatures with simultaneous high flow and reduced expansion.

Fiber-pipes can be, analogue to solid-wall pipes, directly welded without a prior processing step.

Material

PP-RCT (Polypropylene - Random copolymer, Crystalline structure, Temperature resistant) with modified crystalline structure (beta nucleated) and increased temperature resistance, Borealis RA7050GN, colour RAL 6024 traffic green. The material complies with the requirements of the KTW guideline of the German Federal Environmental Agency (UBA).

Geometric Properties

Dimensions and tolerances according to DIN 8077 and DIN EN ISO 15874-2.

Operating Pressure

Up to D125 = 20°C/2.0 MPa • 70°C/1.0 MPa.

From D160 = 20°C/1.6 MPa • 70°C/0.8 MPa.

Type

Suitable for socket-welding, butt-welding and electrofusion-socket-welding according to DVS technical code 2207. Welding equipment according to DVS technical code 2208.

Certification

B-R pipes succumb frequent internal and external quality controls. The pipes fulfill the requirements of the DIN Certco guideline ZP 9.12.1 and NSF14 + 61.

Delivery

Up to D200 in 4 m rods and from D250 in 5.8 m rods; packed in bundles or from D125 and above individually packed. All pipes/bundles are packed in black UV-protection-foil. Supply only in complete packing units (PU's).

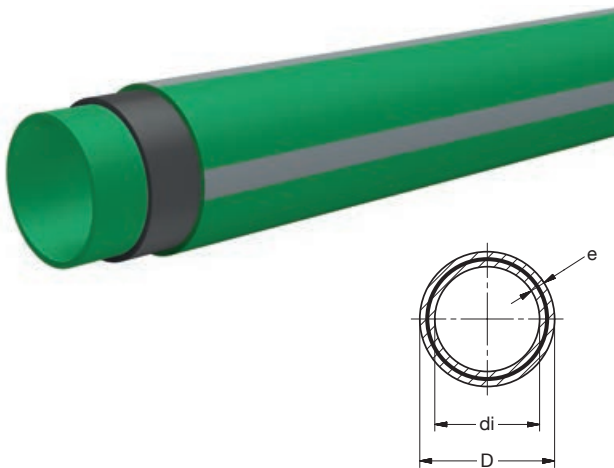

BR PP-RCT Druckrohr **WATERTEC** grün

BR PP-RCT Pressure pipe **WATERTEC** green

Art Nr	D	e	DN	di	SDR	L	KG	VE1	VE2
Art No	[mm]		[mm]	[mm]		[m]		PU1	PU2
20°C / 2,0 MPa • 70°C / 1,0 MPa									
7FW2 0640 11	20	2,8	15	14,4	7,4	4	0,15	100	3500
7FW2 0740 11	25	3,5	20	18,0	7,4	4	0,23	100	2300
7FW3 0840 11	32	3,6	25	24,8	9	4	0,34	60	1200
7FW3 0940 11	40	4,5	32	31,0	9	4	0,51	40	840
7FW3 1040 11	50	5,6	40	38,8	9	4	0,75	20	600
7FW3 1140 11	63	7,1	50	48,8	9	4	1,24	20	400
7FW3 1240 11	75	8,4	-	58,2	9	4	1,70	8	256
7FW3 1340 11	90	10,1	65	69,8	9	4	2,45	8	176
7FW3 1440 11	110	12,3	80	85,4	9	4	3,65	8	120
7FW3 1540 11	125	14,0	100	97,0	9	4	4,48	4	100
20°C / 1.6 MPa • 70°C / 0.8 MPa									
7FW4 1740 11	160	14,6	125	130,8	11	4	6,76	4	48
7FW4 1940 11	200	18,2	160	163,6	11	4	10,6	4	36
7FW4 2158 11	250	22,7	200	204,6	11	5,8	16,2	5,8	29
7FW4 2358 11	315	28,6	250	257,8	11	5,8	25,4	5,8	11,6
7FW4 2458 11	355	32,2	300	290,6	11	5,8	36,5	5,8	11,6
7FW4 2558 11	400	36,3	-	327,4	11	5,8	40,6	5,8	-
7FW4 2658 11	450	40,9	350	368,2	11	5,8	57,3	5,8	-
7FW4 2758 11	500	45,4	400	409,2	11	5,8	65	5,8	-

CLIMATEC

Beschreibung

PP-RCT Druckrohr CLIMATEC, mehrlagig, mit Faser-Mittelschicht zur Reduzierung der axialen Ausdehnung, SDR7,4 bis 17. Optional mit einer blauen Außenschicht lieferbar.

Für normale Drücke und hohe Temperaturen, sehr hohem Durchfluß und reduzierter Längenausdehnung.

Faser-Rohre können, analog zu Vollwand-Rohren, ohne vorherigen Bearbeitungsschritt direkt verschweißt werden.

Werkstoff

PP-RCT (Polypropylen - Random copolymer, Crystalline structure, Temperature resistant) mit modifizierter Kristallstruktur (beta nukleiert) und erhöhter Temperaturbeständigkeit, Borealis RA7050GN, Farbe RAL 6024 Verkehrsgrün.

Das Material entspricht den Anforderungen der aktuellen KTW-Leitlinie des Umweltbundesamtes (UBA).

Geometrische Eigenschaften

Abmessungen und Toleranzen entsprechend DIN 8077 und DIN EN ISO 15874-2.

Betriebsdruck

Bis D125 = 20°C/1,6 MPa • 70°C/0,8 MPa.

Ab D160 = 20°C/1,0 MPa • 70°C/0,5 MPa.

Ausführung

Geeignet für Heizelement-Muffen-Schweißung, Heizelement-Stumpf-Schweißung und Heizwendel-Muffen-Schweißung nach DVS Richtlinie 2207. Schweiß-Geräte und Schweiß-Werkzeuge sollten der DVS Richtlinie 2208 entsprechen.

Zertifizierung

B-R Rohre unterliegen regelmäßigen internen und externen Qualitätskontrollen. Die Rohre erfüllen die Anforderungen der DIN Certco Richtlinie ZP 9.12.1 und NSF14 + 61.

Lieferung

Bis D200 in 4 m Stangen und ab D250 in 5,8 m Stangen; abgepackt in Bündeln, bzw. ab D125 einzelverpackt. Alle Rohre/Bünde sind in schwarzer UV-Schutz-Schlauchfolie verpackt. Abgabe erfolgt nur in kompletten Verpackungseinheiten (VE's).

Description

PP-RCT Pressure pipe CLIMATEC, multi-layer, with fiber-middle-layer for reduced axial expansion, SDR7,4 up to 17. Optionally available with a blue outer layer.

For normal pressures and high temperatures, very high flow and reduced expansion. Fiber-pipes can be, analogue to solid-wall pipes, directly welded without a prior processing step.

Material

PP-RCT (Polypropylene - Random copolymer, Crystalline structure, Temperature resistant) with modified crystalline structure (beta nucleated) and increased temperature resistance, Borealis RA7050GN, colour RAL 6024 traffic green.

The material complies with the requirements of the KTW guideline of the German Federal Environmental Agency (UBA).

Geometric Properties

Dimensions and tolerances according to DIN 8077 and DIN EN ISO 15874-2.

Operating Pressure

Up to D125 = 20°C/1.6 MPa • 70°C/0.8 MPa.

From D160 = 20°C/1.0 MPa • 70°C/0.5 MPa.

Type

Suitable for socket-welding, butt-welding and electrofusion-socket-welding according to DVS technical code 2207. Welding equipment according to DVS technical code 2208.

Certification

B-R pipes succumb frequent internal and external quality controls. The pipes fulfill the requirements of the DIN Certco guideline ZP 9.12.1 and NSF14 + 61.

Delivery

Up to D200 in 4 m rods and from D250 in 5.8 m rods; packed in bundles or from D125 and above individually packed. All pipes/bundles are packed in black UV-protection-foil. Supply only in complete packing units (PU's).

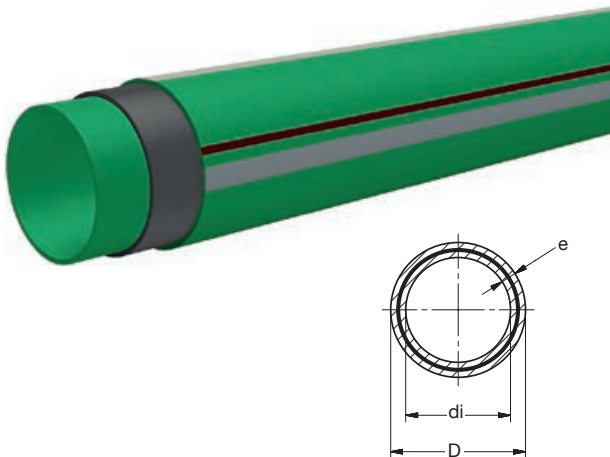

BR PP-RCT Druckrohr **CLIMATEC** grün

BR PP-RCT Pressure pipe **CLIMATEC** green

Art Nr Art No	D [mm]	e [mm]	DN	di [m]	SDR	L [m]	KG	VE1	VE2
								PU1	PU2
20°C / 1,6 MPa • 70°C / 0,8 MPa									
7FC2 0640 11	20	2,8	15	14,4	7,4	4	0,15	100	3500
7FC2 0740 11	25	3,5	20	18,0	7,4	4	0,24	100	2300
7FC3 0840 11	32	3,6	25	24,8	9	4	0,34	60	1200
7FC4 0940 11	40	3,7	32	32,6	11	4	0,44	40	840
7FC4 1040 11	50	4,6	40	40,8	11	4	0,68	20	600
7FC4 1140 11	63	5,8	50	51,4	11	4	1,00	20	400
7FC4 1240 11	75	6,8	-	61,4	11	4	1,42	8	256
7FC4 1340 11	90	8,2	65	73,6	11	4	2,04	8	176
7FC4 1440 11	110	10,0	80	90,0	11	4	3,03	8	120
7FC4 1540 11	125	11,4	100	102,2	11	4	3,35	4	100
20°C / 1,0 MPa • 70°C / 0,5 MPa									
7FC5 1740 11	160	9,5	150	141,0	17	4	4,64	4	48
7FC5 1940 11	200	11,9	180	176,2	17	4	7,32	4	36
7FC5 2158 11	250	14,8	220	220,4	17	5,8	11,1	5,8	29
7FC5 2358 11	315	18,7	250	277,6	17	5,8	17,2	5,8	11,6
7FC5 2458 11	355	21,2	300	312,6	17	5,8	21,9	5,8	11,6
7FC5 2558 11	400	23,7	350	352,6	17	5,8	27,8	5,8	-
7FC5 2658 11	450	26,7	400	396,6	17	5,8	37,2	5,8	-
7FC5 2758 11	500	29,7	450	440,6	17	5,8	45,0	5,8	-

CLIMATEC-blue

Beschreibung

PP-RCT Druckrohr CLIMATEC-blue, mehrlagig, mit Faser-Mittelschicht zur Reduzierung der axialen Ausdehnung, SDR7,4 bis 11.

Für normale Drücke und hohe Temperaturen, sehr hohem Durchfluss und reduzierter Längenausdehnung.

Faser-Rohre können, analog zu Vollwand-Rohren, ohne vorherigen Bearbeitungsschritt direkt verschweißt werden.

Werkstoff

PP-RCT (Polypropylen - Random copolymer, Crystalline structure, Temperature resistant) mit modifizierter Kristallstruktur (beta nukleiert) und erhöhter Temperaturbeständigkeit, Borealis RA7050GN, Farbe RAL 6024 Verkehrsgrün.

Das Material entspricht den Anforderungen der aktuellen KTW-Leitlinie des Umweltbundesamtes (UBA).

Geometrische Eigenschaften

Abmessungen und Toleranzen entsprechend DIN 8077 und DIN EN ISO 15874-2.

Betriebsdruck

20°C/1,6 MPa • 70°C/0,8 MPa.

Ausführung

Geeignet für Heizelement-Muffen-Schweißung, Heizelement-Stumpf-Schweißung und Heizwendel-Muffen-Schweißung nach DVS Richtlinie 2207. Schweiß-Geräte und Schweiß-Werkzeuge sollten der DVS Richtlinie 2208 entsprechen.

Zertifizierung

B-R Rohre unterliegen regelmäßigen internen und externen Qualitätskontrollen. Die Rohre erfüllen die Anforderungen der DIN Certco Richtlinie ZP 9.12.1 und NSF14 + 61.

Lieferung

Bis D200 in 4 m Stangen und ab D250 in 5,8 m Stangen; abgepackt in Bunden, bzw. ab D125 einzelnverpackt. Alle Rohre/Bunde sind in schwarzer UV-Schutz-Schlauchfolie verpackt. Abgabe erfolgt nur in kompletten Verpackungseinheiten (VE's).

Description

PP-RCT Pressure pipe CLIMATEC-blue, multi-layer, with fiber-middle-layer for reduced axial expansion, SDR7,4 up to 11.

For normal pressures and high temperatures, very high flow and reduced expansion. Fiber-pipes can be, analogue to solid-wall pipes, directly welded without a prior processing step.

Material

PP-RCT (Polypropylene - Random copolymer, Crystalline structure, Temperature resistant) with modified crystalline structure (beta nucleated) and increased temperature resistance, Borealis RA7050GN, colour RAL 6024 traffic green.

The material complies with the requirements of the KTW guideline of the German Federal Environmental Agency (UBA).

Geometric Properties

Dimensions and tolerances according to DIN 8077 and DIN EN ISO 15874-2.

Operating Pressure

20°C/1.6 MPa • 70°C/0.8 MPa.

Type

Suitable for socket-welding, butt-welding and electrofusion-socket-welding according to DVS technical code 2207. Welding equipment according to DVS technical code 2208.

Certification

B-R pipes succumb frequent internal and external quality controls. The pipes fulfill the requirements of the DIN Certco guideline ZP 9.12.1 and NSF14 + 61.

Delivery

Up to D200 in 4 m rods and from D250 in 5.8 m rods; packed in bundles or from D125 and above individually packed. All pipes/bundles are packed in black UV-protection-foil. Supply only in complete packing units (PU's).

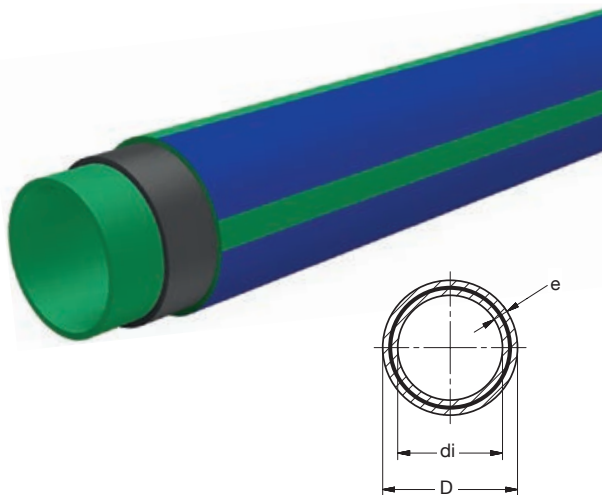

BR PP-RCT Druckrohr **CLIMATEC-blue**

BR PP-RCT Pressure pipe **CLIMATEC-blue**

Art Nr	D	e	DN	di	SDR	L	KG	VE1	VE2
Art No	[mm]			[mm]		[m]		PU1	PU2
20°C / 1,6 MPa • 70°C / 0,8 MPa									
7FC2 0640 14	20	2,8	15	14,4	7,4	4	0,15	100	3500
7FC2 0740 14	25	3,5	20	18,0	7,4	4	0,24	100	2300
7FC3 0840 14	32	3,6	25	24,8	9	4	0,34	60	1200
7FC4 0940 14	40	3,7	32	32,6	11	4	0,44	40	840
7FC4 1040 14	50	4,6	40	40,8	11	4	0,68	20	600
7FC4 1140 14	63	5,8	50	51,4	11	4	1,00	20	400
7FC4 1240 14	75	6,8	-	61,4	11	4	1,42	8	256
7FC4 1340 14	90	8,2	65	73,6	11	4	2,04	8	176
7FC4 1440 14	110	10,0	80	90,0	11	4	3,03	8	120
7FC4 1540 14	125	11,4	100	102,2	11	4	3,35	4	100

WATERTEC-UV (mit UV-Schutzschicht)

Beschreibung

Die PP-RCT Druckrohre WATERTEC sind mit einer zusätzlichen äußeren schwarzen Schutzschicht gegen UV-Einstrahlung lieferbar. Die Schutzschicht besteht aus PP-R Material und ist ausgelegt auf mitteleuropäische Verhältnisse.

Werkstoff

PP-RCT (Polypropylen - Random copolymer, Crystalline structure, Temperature resistant) mit modifizierter Kristallstruktur (beta nukleiert) und erhöhter Temperaturbeständigkeit, Borealis RA7050GN, Farbe RAL 6024 Verkehrsgrün. Das Material entspricht den Anforderungen der aktuellen KTW-Leitlinie des Umweltbundesamtes (UBA). Äußere PP-R UV-Schutz-Deckschicht in schwarz.

Geometrische Eigenschaften und Betriebsdrücke

Siehe Ausführungen zu den aufgeführten Rohrtypen.

Lieferung

Bis D200 in 4 m Stangen und ab D250 in 5,8 m Stangen; abgepackt in Bunden, bzw. ab D125 einzeln verpackt. Alle Rohre/Bunde sind in schwarzer UV-Schutz-Schlauchfolie verpackt. Abgabe erfolgt nur in kompletten Verpackungseinheiten (VE's).

WATERTEC-UV (with UV-protection-layer)

Description

The PP-RCT pressure pipes WATERTEC are available with an additional outer black protective layer against UV irradiation. The protective layer consists of PP-R material and is designed for Central European conditions.

Material

PP-RCT (Polypropylene - Random copolymer, Crystalline structure, Temperature resistant) with modified crystalline structure (beta nucleated) and increased temperature resistance, Borealis RA7050GN, colour RAL 6024 traffic green. The material complies with the requirements of the KTW guideline of the German Federal Environmental Agency (UBA). Outer PP-R UV-protection-layer in black colour.

Geometric Properties and Operating Pressure

See explanations for the listed pipe types.

Delivery

Up to D200 in 4 m rods and from D250 in 5.8 m rods; packed in bundles or from D125 and above individually packed. All pipes/bundles are packed in black UV-protection-foil. Supply only in complete packing units (PU's).

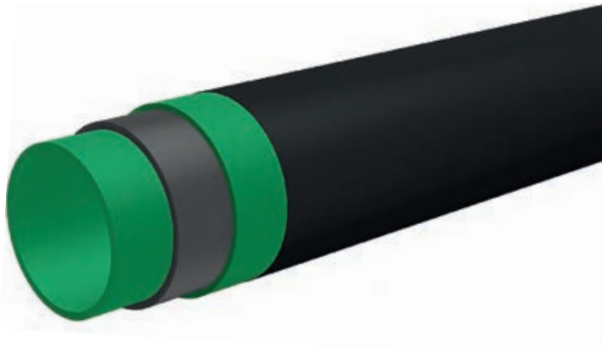

BR PP-RCT Druckrohr **WATERTEC-UV** schwarz

BR PP-RCT Pressure pipe **WATERTEC-UV** black

Art Nr	D	L	KG	VE1	VE2
Art No	[mm]	[m]		PU1	PU2
7FW2 0640 S1	20	4	0,15	100	3500
7FW2 0740 S1	25	4	0,23	100	2300
7FW3 0840 S1	32	4	0,34	60	1200
7FW3 0940 S1	40	4	0,51	40	840
7FW3 1040 S1	50	4	0,75	20	600
7FW3 1140 S1	63	4	1,24	20	400
7FW3 1240 S1	75	4	1,70	8	256
7FW3 1340 S1	90	4	2,45	8	176
7FW3 1440 S1	110	4	3,65	8	120
7FW3 1540 S1	125	4	4,48	4	100

Vorisolierte Rohre

Beschreibung

Vorisolierte Kunststoffmantelrohre zur direkten Erdverlegung. Die Herstellung erfolgt Auftragsbezogen. Aus technischen Gründen sind nur Rohrlängen in 5,8 m mit Vorisolierung lieferbar. Bitte beachten Sie, dass bis Dimension 200 Rohre in 5,8 m Länge keine Lagerware ist. Bitte berücksichtigen sie verlängerte Beschaffungszeiten, da diese Rohre erst produziert werden müssen und nur an eine planmäßige Fertigung angehängt werden können.

Mediumrohr

BR Kunststoffrohre (außer STABITEC) in den Dimensionen 20 bis 500 mm. Bevorzugt kommen hier die Faserrohr-Serien WATERTEC und CLIMATEC zum Einsatz.

Mantelrohr

Nahtlos extrudiertes PE-HD Mantelrohr, schlag- und bruchfest, zähelastisch bis -50°C, allgemeine Güteanforderungen nach DIN 8075, Maße und Wanddicke nach DIN EN 253, Corona behandelt.

Wärmedämmung

Aus geschäumtem Polyurethan Hartschaum, FCKW-frei, Treibmittel Cyclopentan, zwischen Mediumrohr und Schutzmantel im Verbund, Wärmeleitzahl Lambda mind. 0,026 W/mK.

Dämmstärke DS1: Standard nach DIN EN 253.

Lieferung

In 5,8 m Stangen. Abgabe erfolgt nur in kompletten Verpackungseinheiten (VEs).

Kein Lagerartikel.

Preinsulated Pipes

Description

Pre-insulated plastic sheathing pipes for direct laying. Production is carried out by order. Because of technical reasons, only pipe lengths of 5.8 m are available with pre-insulation. Please note that up to dimension 200 pipes in 5.8 m are not a stock item. Please take into account extended procurement times, as these pipes have to be produced first and can only be attached to a scheduled production.

Medium pipe

BR plastic pipes (except STABITEC) in the dimensions 20 to 500 mm. The fiber-pipe series WATERTEC and CLIMATEC are preferred here.

Casing pipe

Seamlessly extruded PE-HD casing pipe, impact and break resistant, tough to -50°C, general quality requirements according to DIN 8075, dimensions and wall thickness according to DIN EN 253, Corona treated.

Type

Made of foamed polyurethane rigid foam, CFC-free, propellant cyclopentane, between medium pipe and protective sheath in the composite, heat transfer coefficient Lambda min. 0.026 W/mK.

Insulation thickness DS1: Standard according to DIN EN 253.

Delivery

In 5.8 m rods. Supply only in complete packing units (PU's).

Not a stock item.

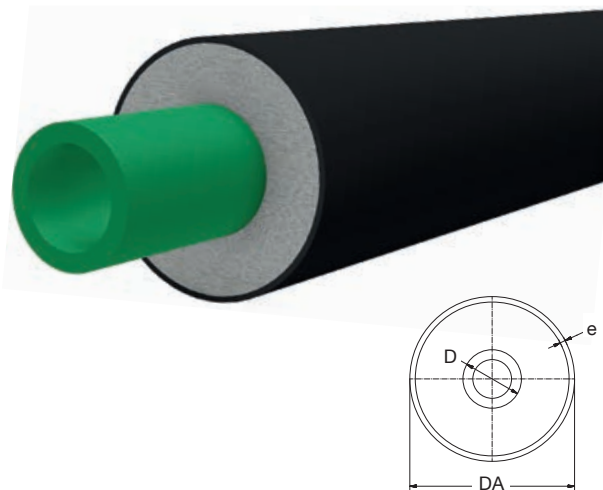

Druckrohre vorisoliert

Pressure pipes preinsulated

D [mm]	Länge [m]	DA [mm]	e [mm]	ISO [mm]
20	5,8	90	3,0	32
25	5,8	90	3,0	30
32	5,8	90	3,0	26
40	5,8	110	3,0	32
50	5,8	110	3,0	27
63	5,8	125	3,0	28
75	5,8	140	3,0	30
90	5,8	160	3,0	32
110	5,8	200	3,2	42
125	5,8	225	3,5	47
160	5,8	250	3,6	41
200	5,8	315	4,5	53
250	5,8	355	5,0	48
315	5,8	450	5,6	62
355	5,8	500	6,3	66
400	5,8	560	7,0	73
450	5,8	630	7,6	82
500	5,8	670	8,0	77

Mindestmenge und Preise auf Anfrage.

Minimum quantities and prices on request.

4.02 Formteile Muffen-Schweißen • Fittings socket-welding

Beschreibung

Gespritzte Formteile, für die Heizelement-Muffen-Schweißung, ohne Verschwächungsbeiwerte.

Werkstoff

PP-RCT (Polypropylen - Random copolymer, Crystalline structure, Temperature resistant) mit modifizierter Kristallstruktur (beta nukleiert) und erhöhter Temperaturbeständigkeit, Borealis RA7050GN, Farbe RAL 6024 Verkehrsgrün.

Das Material entspricht den Anforderungen der aktuellen KTW-Leitlinie des Umweltbundesamtes (UBA).

Geometrische Eigenschaften

Abmessungen und Toleranzen der Muffen entsprechend DIN EN ISO 15874-3; Muffe Type A.

Toleranzen bei den Z-Maßangaben sind abhängig von der Dimension. Bis d/D 160 = +/- 3 mm. Ab d/D 180 = +/- 10 mm.

Betriebsdruck

Der Betriebsdruck richtet sich üblicherweise nach dem eingesetzten Rohr. Grundsätzlich sind alle Standard-Formteile für die angebotenen Rohre geeignet.

Ausführung

Geeignet für Heizelement-Muffen-Schweißung nach DVS Richtlinie 2207. Schweißgeräte und Schweiß-Werkzeuge sollten der DVS Richtlinie 2208 entsprechen.

Zertifizierung

B-R Formteile unterliegen regelmäßigen internen und externen Qualitätskontrollen. Die Formteile erfüllen die Anforderungen der DIN Certco Richtlinie ZP 10.25.1 und NSF14 + 61.

Lieferung

Abgabe erfolgt nur in kompletten Verpackungseinheiten (VE's).

Description

Injection moulded fittings, for socket-welding and without pressure reduction factors.

Material

PP-RCT (Polypropylene - Random copolymer, Crystalline structure, Temperature resistant) with modified crystalline structure (beta nucleated) and increased temperature resistance, Borealis RA7050GN, colour RAL 6024 traffic green.

The material complies with the requirements of the KTW guideline of the German Federal Environmental Agency (UBA).

Geometric Properties

Dimensions and tolerances of the sockets according to DIN EN ISO 15874-3; socket type A.

Tolerances of z-sizes depend on the dimension. Up to d/D 160 = +/- 3 mm and from d/D 180 = +/- 10 mm.

Operating pressure

The operating pressure usually depends on the used pipe. Basically, all standard fittings are suitable for the offered pipes.

Type

Suitable for socket-welding according to DVS technical code 2207. Welding equipment according to DVS technical code 2208.

Certification

B-R fittings succumb frequent internal and external quality controls. The fittings fulfill the requirements of the DIN Certco guideline ZP 10.25.1 and NSF14 + 61.

Delivery

Supply only in complete packing units (PU's).

4.02.01 Bögen, Winkel • Bends, Elbows

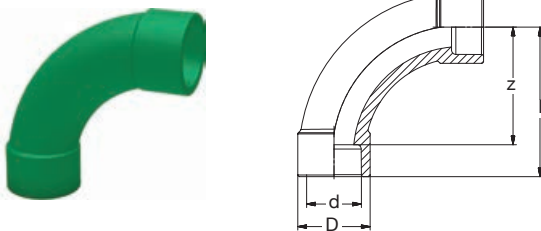

BR PP-RCT Bogen 90° grün

BR PP-RCT Bend 90° green

Art Nr	d	D	l	z	KG	VE1	VE2
Art No	[mm]		[mm]			PU1	PU2
7421 0690 11	20	28	56	42	0,029	10	60
7421 0790 11	25	34	69	53	0,038	10	40
7421 0890 11	32	42	86	68	0,086	5	40
7421 0990 11	40	52	106	86	0,157	5	30

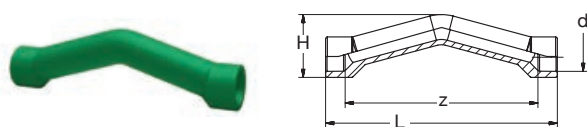

BR PP-RCT Überspringbogen Muffe grün

BR PP-RCT Crossover socket green

Art Nr	d	H	L	z	KG	VE1	VE2
Art No	[mm]		[mm]			PU1	PU2
7461 0600 11	20	45	160	131	0,04	1	110
7461 0700 11	25	55	200	168	0,07	1	50
7461 0800 11	32	70	240	204	0,13	1	40

4.02.01 Bögen, Winkel • Bends, Elbows

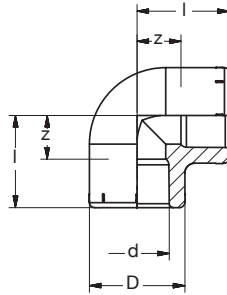

BR PP-RCT Winkel 90° grün
BR PP-RCT Elbow 90° green

Art Nr	d	D	l	z	KG	VE1	VE2
Art No	[mm]	[mm]	[mm]	[mm]		PU1	PU2
7411 0690 11	20	29	28	13	0,019	10	120
7411 0790 11	25	34	32	16	0,025	10	80
7411 0890 11	32	43	38	20	0,047	10	80
7411 0990 11	40	52	44	23	0,073	5	50
7411 1090 11	50	65	52	28	0,136	10	60
7411 1190 11	63	84	62	34	0,266	4	32
7411 1290 11	75	101	71	41	0,443	2	18
7411 1390 11	90	120	83	50	0,793	2	12
7411 1490 11	110	148	99	62	1,299	1	3
7411 1590 11	125	165	124	84	2,056	1	4

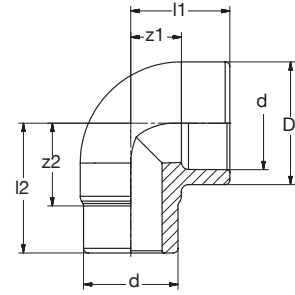

BR PP-RCT Winkel 90° i-a grün
BR PP-RCT Elbow 90° f-m green

Art Nr	d	D	l1	l2	z1	z2	KG	VE1	VE2
Art No	[mm]	[mm]	[mm]	[mm]	[mm]	[mm]		PU1	PU2
7412 0690 11	20	29	27	36	12	21,5	0,018	10	140
7412 0790 11	25	34	30	41	14	25	0,026	10	80
7412 0890 11	32	43	36	48	18	30	0,048	10	50
7412 0990 11	40	52	42	55	21	34,5	0,075	5	30

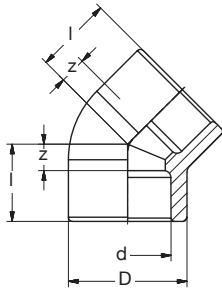

BR PP-RCT Winkel 45° grün
BR PP-RCT Elbow 45° green

Art Nr	d	D	l	z	KG	VE1	VE2
Art No	[mm]	[mm]	[mm]	[mm]		PU1	PU2
7411 0645 11	20	29	21	6	0,014	10	150
7411 0745 11	25	34	24	8	0,019	10	80
7411 0845 11	32	43	28	10	0,034	10	50
7411 0945 11	40	52	32	11	0,056	5	30
7411 1045 11	50	65	37	13	0,101	5	45
7411 1145 11	63	82	44	16	0,207	2	40
7411 1245 11	75	99	50	20	0,321	2	24
7411 1345 11	90	120	58	25	0,580	2	10
7411 1445 11	110	148	69	32	0,979	2	4
7411 1545 11	125	165	77	37	1,37	1	6

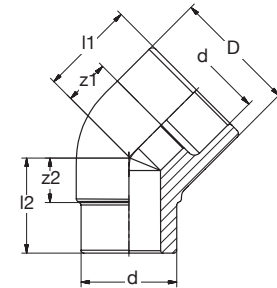

BR PP-RCT Winkel 45° i-a grün
BR PP-RCT Elbow 45° f-m green

Art Nr	d	D	l1	l2	z1	z2	KG	VE1	VE2
Art No	[mm]	[mm]	[mm]	[mm]	[mm]	[mm]		PU1	PU2
7412 0645 11	20	29	20	28	5	14	0,013	10	120
7412 0745 11	25	34	22	34	5	18	0,023	10	80
7412 0845 11	32	43	26	39	8	21	0,041	10	50

4.02.02 T-Stücke, Abzweige • Tee's, Branches

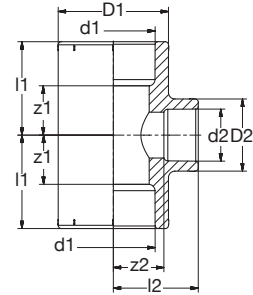
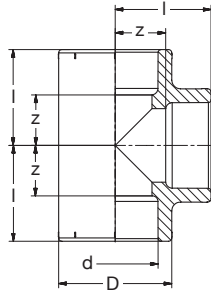

BR PP-RCT T-Stück 90° grün
BR PP-RCT Tee 90° green

Art Nr	d	D	l	z	KG	VE1	VE2
Art No	[mm]	[mm]	[mm]	[mm]		PU1	PU2
7511 0690 11	20	29	28	13	0,023	10	80
7511 0790 11	25	34	32	16	0,034	10	50
7511 0890 11	32	43	38	20	0,060	5	70
7511 0990 11	40	52	44	23	0,090	10	40
7511 1090 11	50	65	52	28	0,17	10	50
7511 1190 11	63	84	62	34	0,34	2	8
7511 1290 11	75	100	71	41	0,54	2	16
7511 1390 11	90	120	83	50	0,95	2	12
7511 1490 11	110	148	99	62	1,56	1	2
7511 1590 11	125	165	124	84	2,51	1	4

BR PP-RCT T-Stück 90° red grün
BR PP-RCT Tee 90° red green

Art Nr	d1-d2	D1	D2	l1	l2	z1	z2	KG	VE1	VE2
Art No	[mm]	[mm]	[mm]	[mm]	[mm]	[mm]	[mm]		PU1	PU2
7521 0706 11	25-20	34	29	32	32	16	17	0,035	10	60
7521 0806 11	32-20	43	29	38	36	20	21	0,060	10	30
7521 0807 11	32-25	43	34	38	36	20	22	0,060	10	30
7521 0906 11	40-20	52	43	44	39	24	24	0,083	5	40
7521 0907 11	40-25	52	43	44	40	23	24	0,086	5	40
7521 0908 11	40-32	52	43	44	40	23	22	0,091	5	40
7521 1006 11	50-20	65	43	52	46	28	31	0,16	10	50
7521 1007 11	50-25	65	43	52	46	28	30	0,16	10	50
7521 1008 11	50-32	65	43	52	46	28	28	0,16	10	50
7521 1009 11	50-40	85	85	62	62	39	35	0,16	10	50
7521 1106 11	63-20	85	43	62	62	35	48	0,31	2	8
7521 1107 11	63-25	85	43	62	62	35	46	0,31	2	8
7521 1108 11	63-32	85	43	62	62	35	44	0,31	2	8
7521 1109 11	63-40	85	85	62	62	35	42	0,32	2	8
7521 1110 11	63-50	85	85	62	62	35	39	0,32	2	8
7521 1206 11	75-20	100	43	71	71	41	57	0,50	2	16
7521 1207 11	75-25	100	43	71	71	41	55	0,50	2	16
7521 1208 11	75-32	100	43	71	71	41	53	0,50	2	16
7521 1209 11	75-40	100	65	71	71	41	51	0,50	2	16
7521 1210 11	75-50	100	65	71	71	41	48	0,51	2	16
7521 1211 11	75-63	100	101	71	71	41	44	0,52	2	16
7521 1311 11	90-63	85	83	83	50	50	53	0,91	2	12
7521 1312 11	90-75	120	100	83	83	50	53	0,91	2	12
7521 1411 11	110-63	148	85	99	99	62	71	1,53	1	3
7521 1412 11	110-75	148	100	99	99	62	69	1,54	1	3
7521 1413 11	110-90	148	120	99	99	62	66	1,57	1	3
7521 1512 11	125-75	165	100	124	104	84	74	2,30	1	4
7521 1513 11	125-90	165	120	124	106	84	73	2,28	1	4
7521 1514 11	125-110	165	148	124	110	84	87	2,36	1	4
7521 0607 11	20-25	34	34	32	32	18	16	0,04	10	60

BR PP-RCT T-Stück 90° multi-red grün
BR PP-RCT Tee 90° multi-red green

Art Nr	d1-d2-d3	D1	D2	l1	l2	z1	z2	KG	VE1	VE2
Art No	[mm]	[mm]	[mm]	[mm]	[mm]	[mm]	[mm]		PU1	PU2
7521 07BB 11	25-20-20	34	34	32	32	16	18	0,038	10	60
7521 07CB 11	25-25-20	34	34	32	32	16	16	0,038	10	60
7521 08BB 01	32-20-20	43	34	37	38	18	22	0,078	5	30
7521 08BC 21	32-20-25	43	34	37	38	18	23	0,078	5	30
7521 08CC 21	32-25-25	43	34	37	38	18	22	0,078	5	30
7521 11EF 11	63-40-50	85	85	62	62	39	35	0,37	1	8

4.02.02 T-Stücke, Abzweige • Tee's, Branches

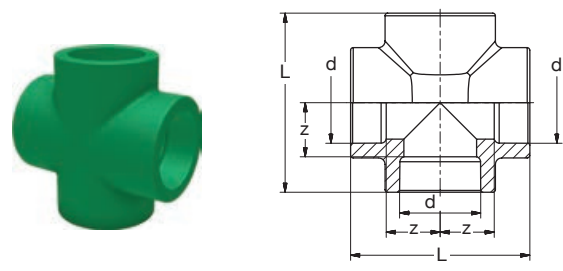
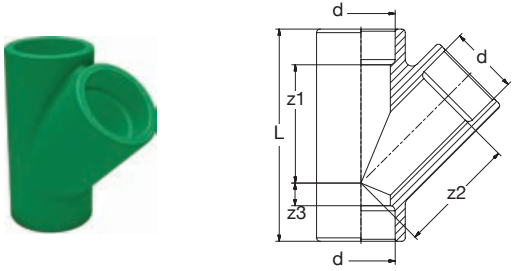

BR PP-RCT Abzweig 45° **SDR11** grün
BR PP-RCT Branch 45° **SDR11** green

BR PP-RCT Kreuzstück **SDR11** grün
BR PP-RCT Cross **SDR11** green

Art Nr	d	L	z1	z2	z3	KG	VE1	VE2
Art No	[mm]	[mm]				PU1	PU2	
7511 0845 11	32	89	40	41	11	0,062	10	50
7511 0945 11	40	122	65	64	16	0,15	1	30
7511 1045 11	50	131	67	67	18	0,23	1	20
7511 1145 11	63	169	91	89	23	0,50	1	20

Art Nr	d	L	z	KG	VE1	VE2
Art No	[mm]	[mm]			PU1	PU2
7551 0600 21	20	52	23	0,022	10	80
7551 0700 21	25	59	27	0,037	10	50
7551 0800 11	32	78	34	0,059	10	50
7551 0900 11	40	94	42	0,11	1	80
7551 1000 11	50	112	66	0,20	1	30
7551 1100 11	63	138	84	0,35	1	20

4.02.03 Reduktionen, Muffen, Kappen • Reducers, Sockets, Caps

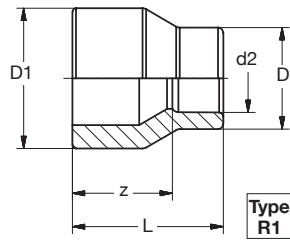

Type R1

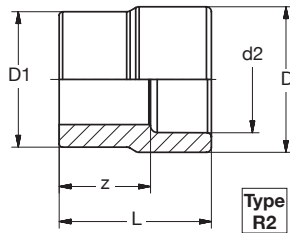
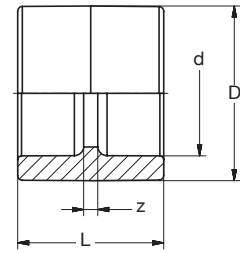

Type R2

BR PP-RCT Reduktion grün

BR PP-RCT Reducer green

Art Nr Art No	D1 - d2 [mm]	Type		D2	L	z	KG	VE1	VE2
		R1	R2					PU1	PU2
7321 0706 11	25-20	•		29	36	22	0,012	10	100
7321 0806 11	32-20	•		29	37	23	0,015	10	80
7321 0807 11	32-25	•		34	39	23	0,017	10	70
7321 0906 11	40-20	•		34	43	28	0,023	10	50
7321 0907 11	40-25	•		34	43	27	0,023	10	50
7321 0908 11	40-32	•		43	45	27	0,029	10	80
7321 1006 11	50-20	•		43	51	36	0,043	10	50
7321 1007 11	50-25	•		43	51	35	0,043	10	50
7321 1008 11	50-32	•		43	51	33	0,045	10	50
7321 1009 11	50-40	•		52	53	33	0,055	10	70
7321 1106 11	63-20	•		34	56	42	0,079	5	60
7321 1107 11	63-25	•		34	56	40	0,076	5	60
7321 1108 11	63-32	•		43	58	40	0,076	5	60
7321 1109 11	63-40	•		52	60	40	0,084	5	45
7321 1110 11	63-50	•		65	63	40	0,091	5	40
7321 1210 11	75-50	•		65	67	44	0,12	2	16
7321 1211 11	75-63	•		80	71	44	0,15	2	16
7321 1310 11	90-50	•		65	74	51	0,15	2	12
7321 1311 11	90-63	•		80	78	51	0,17	2	12
7321 1312 11	90-75	•		99	81	51	0,23	2	12
7321 1411 11	110-63	•		85	87	60	0,32	2	14
7321 1412 11	110-75	•		100	90	60	0,37	2	14
7321 1413 11	110-90	•		120	93	61	0,45	2	14

BR PP-RCT Muffe grün

BR PP-RCT Socket green

Art Nr Art No	d [mm]	D	L	z	KG	VE1	VE2
						PU1	PU2
7311 0600 11	20	29	34	5	0,010	10	150
7311 0700 11	25	34	37	5	0,015	10	120
7311 0800 11	32	43	41	5	0,026	10	60
7311 0900 11	40	52	46	5	0,047	10	80
7311 1000 11	50	65	52	5	0,070	5	60
7311 1100 11	63	84	60	5	0,13	4	84
7311 1200 11	75	99	65	5	0,20	2	40
7311 1300 11	90	120	76	10	0,35	2	16
7311 1400 11	110	148	80	6	0,57	2	18
7311 1500 11	125	165	90	10	0,76	2	6

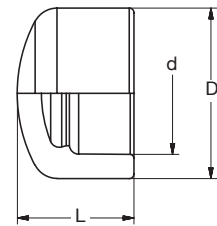

BR PP-RCT Kappe grün

BR PP-RCT Cap green

Art Nr Art No	d [mm]	D	L	KG	VE1	VE2
					PU1	PU2
7341 0600 11	20	29	25	0,009	10	200
7341 0700 11	25	34	28	0,013	10	100
7341 0800 11	32	43	32	0,021	10	120
7341 0900 11	40	52	36	0,033	10	60
7341 1000 11	50	65	41	0,057	10	80
7341 1100 11	63	79	48	0,090	5	60
7341 1200 11	75	99	54	0,18	2	20
7341 1300 11	90	120	66	0,35	2	8
7341 1400 11	110	148	79	0,59	1	8
7341 1500 11	125	165	87	0,76	1	6

4.02.04 Übergänge • Transitions

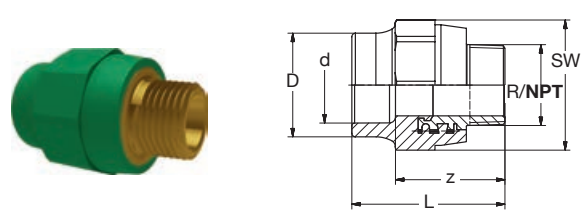
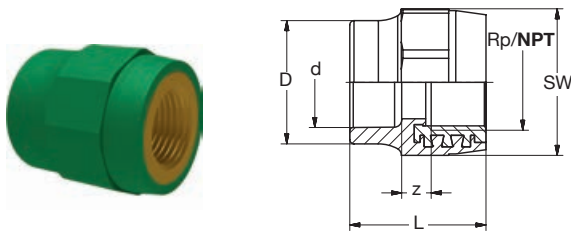

BR PP-RCT-RG Übergang **IG-zyl** grün

BR PP-RCT-Bronze Transition **female-thread-cyl** green

Art Nr	d x Rp	D	L	z	SW	KG	VE1	VE2
Art No	[mm x Inch]	[mm]				PU1	PU2	
7R11 0643 11	20 x 1/2	30	40	11	36	0,057	10	60
7R11 0645 11	20 x 3/4	29	40	11	44	0,077	10	80
7R11 0743 11	25 x 1/2	34	41	11	36	0,057	10	60
7R11 0745 11	25 x 3/4	34	41	11	44	0,077	10	40
7R11 0845 11	32 x 3/4	43	45	11	44	0,081	10	80
7R11 0846 11	32 x 1	43	48	12	51	0,13	10	50
7R11 0946 11	40 x 1	55	54	14	63	0,18	2	40
7R11 0947 11	40 x 1 1/4	55	54	13	63	0,20	2	40
7R11 1047 11	50 x 1 1/4	64	58	12	70	0,23	2	24
7R11 1048 11	50 x 1 1/2	64	58	14	70	0,21	2	24
7R11 1150 11	63 x 2	79	69	19	85	0,42	2	18
7R11 1253 11	75 x 2 1/2	99	82	22	115	0,83	2	4
7R11 1355 11	90 x 3	118	102	39	135	1,46	1	8
7R11 1457 11	110 x 4	146	121	42	170	2,13	1	4
7R11 1558 11	125 x 5	168	125	41	208	3,51	1	2

BR PP-RCT-RG Übergang **AG-keg** grün

BR PP-RCT-Bronze Transition **male-thread-con** green

Art Nr	d x R	D	L	z	SW	KG	VE1	VE2
Art No	[mm x Inch]	[mm]				PU1	PU2	
7R11 0673 11	20 x 1/2	29	53	40	36	0,073	10	60
7R11 0675 11	20 x 3/4	34	58	42	44	0,092	10	40
7R11 0773 11	25 x 1/2	34	56	40	36	0,073	10	80
7R11 0775 11	25 x 3/4	34	58	42	44	0,092	10	70
7R11 0875 11	32 x 3/4	43	58	42	44	0,097	10	60
7R11 0876 11	32 x 1	43	66	48	51	0,164	10	40
7R11 0976 11	40 x 1	55	71	51	62	0,21	2	36
7R11 0977 11	40 x 1 1/4	52	74	53	63	0,30	2	24
7R11 1077 11	50 x 1 1/4	64	77	54	70	0,32	2	24
7R11 1078 11	50 x 1 1/2	64	77	54	70	0,35	2	24
7R11 1180 11	63 x 2	79	92	65	85	0,55	2	12
7R11 1283 11	75 x 2 1/2	99	112	82	112	1,20	1	2
7R11 1385 11	90 x 3	120	143	111	135	1,97	1	4
7R11 1487 11	110 x 4	148	161	124	170	2,89	1	2
7R11 1588 11	125 x 5	168	170	130	208	4,38	1	2

BR PP-RCT-LFB Übergang **IG-NPT** grün

BR PP-RCT-LFB Transition **female-thread-NPT** green

Art Nr	d x NPT	D	L	z	SW	KG	VE1	VE2
Art No	[mm x Inch]	[mm]				PU1	PU2	
7L11 0643 U1	20 x 1/2	30	40	11	36	0,057	10	60
7L11 0645 U1	20 x 3/4	29	40	11	44	0,077	10	80
7L11 0745 U1	25 x 3/4	34	41	11	44	0,077	10	40
7L11 0846 U1	32 x 1	43	48	12	51	0,13	10	50
7L11 0947 U1	40 x 1 1/4	55	54	13	63	0,20	2	40
7L11 1048 U1	50 x 1 1/2	64	58	14	70	0,21	2	24
7L11 1150 U1	63 x 2	79	69	19	85	0,42	2	18
7L11 1253 U1	75 x 2 1/2	99	82	22	115	0,83	2	4

BR PP-RCT-LFB Übergang **AG-NPT** grün

BR PP-RCT-LFB Transition **male-thread-NPT** green

Art Nr	d x NPT	D	L	z	SW	KG	VE1	VE2
Art No	[mm x Inch]	[mm]				PU1	PU2	
7L11 0673 U1	20 x 1/2	29	53	40	36	0,073	10	60
7L11 0675 U1	20 x 3/4	34	58	42	44	0,092	10	40
7L11 0775 U1	25 x 3/4	34	58	42	44	0,092	10	70
7L11 0876 U1	32 x 1	43	66	48	51	0,164	10	40
7L11 0977 U1	40 x 1 1/4	52	74	53	63	0,30	2	24
7L11 1077 U1	50 x 1 1/4	64	77	54	70	0,32	2	24
7L11 1078 U1	50 x 1 1/2	64	77	54	70	0,35	2	24
7L11 1180 U1	63 x 2	79	92	65	85	0,55	2	12
7L11 1283 U1	75 x 2 1/2	99	112	82	112	1,20	1	2

4.02.04 Übergänge • Transitions

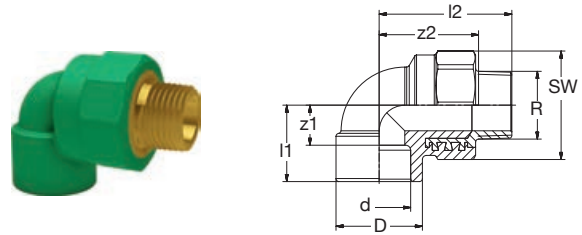
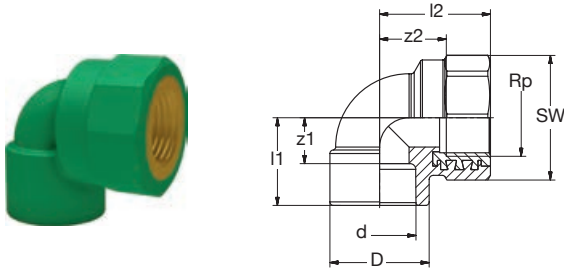

BR PP-RCT-RG Ü-Winkel 90° IG-zyl grün

BR PP-RCT-Bronze Transition-Elbow 90° female-thread-cyl green

Art Nr	d x Rp	D	l1	l2	z1	z2	SW	KG	VE1	VE2
Art No	[mm x Inch]	[mm]						PU1	PU2	
7R21 0643 11	20 x 1/2	29	28	34	14	20	36	0,064	10	80
7R21 0645 11	20 x 3/4	34	32	40	18	25	44	0,093	10	60
7R21 0743 11	25 x 1/2	34	32	36	14	24	36	0,066	10	80
7R21 0745 11	25 x 3/4	34	32	40	16	25	44	0,091	10	60
7R21 0845 11	32 x 3/4	43	38	45	20	30	44	0,11	10	40
7R21 0846 11	32 x 1	43	38	48	20	30	51	0,15	5	40

BR PP-RCT-RG Ü-Winkel 90° AG-keg grün

BR PP-RCT-Bronze Transition-Elbow 90° male-thread-con green

Art Nr	d x R	D	l1	l2	z1	z2	SW	KG	VE1	VE2
Art No	[mm x Inch]	[mm]						PU1	PU2	
7R21 0673 11	20 x 1/2	29	28	34	14	49	36	0,079	10	70
7R21 0675 11	20 x 3/4	34	32	40	18	56	44	0,11	10	40
7R21 0773 11	25 x 1/2	34	32	36	16	53	36	0,095	10	60
7R21 0775 11	25 x 3/4	34	32	40	16	56	44	0,11	10	40
7R21 0875 11	32 x 3/4	43	38	45	20	61	44	0,12	10	30
7R21 0876 11	32 x 1	43	38	48	20	66	51	0,18	10	50

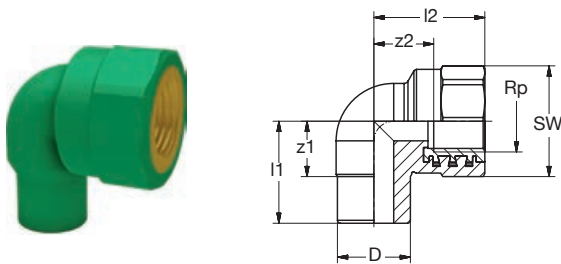

BR PP-RCT-RG Ü-Winkel 90° i IG-zyl grün

BR PP-RCT-Bronze Transition-Elbow 90° fem female-thread-cyl green

Art Nr	d x Rp	l1	l2	z1	z2	SW	KG	VE1	VE2
Art No	[mm x Inch]	[mm]					PU1	PU2	
7R22 0643 11	20 x 1/2	34	34	19	18	36	0,06	10	80

4.02.04 Übergänge • Transitions

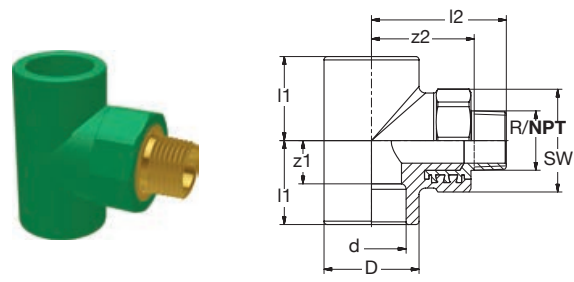
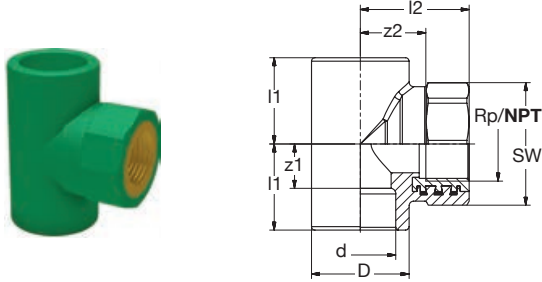

BR PP-RCT-RG Ü-T-Stück 90° **IG-zyl** grün

BR PP-RCT-Bronze Transition-Tee 90° **female-thread-cyl** green

Art Nr	d x Rp	D	l1	l2	z1	z2	SW	KG	VE1	VE2
Art No	[mm x Inch]	[mm]							PU1	PU2
7R41 0643 11	20 x 1/2	29	28	36	14	21	36	0,096	10	60
7R41 0645 11	20 x 3/4	34	28	40	18	24	44	0,11	10	40
7R41 0743 11	25 x 1/2	34	32	36	16	21	36	0,078	10	50
7R41 0745 11	25 x 3/4	34	32	40	16	24	44	0,10	10	40
7R41 0845 11	32 x 3/4	43	38	45	20	31	44	0,12	5	30
7R41 0846 11	32 x 1	43	38	49	20	30	51	0,17	5	30

BR PP-RCT-RG Ü-T-Stück 90° **AG-keg** grün

BR PP-RCT-Bronze Transition-Tee 90° **male-thread-con** green

Art Nr	d x R	D	l1	l2	z1	z2	SW	KG	VE1	VE2
Art No	[mm x Inch]	[mm]							PU1	PU2
7R41 0673 11	20 x 1/2	29	32	49	18	54	36	0,086	10	60
7R41 0675 11	20 x 3/4	34	32	56	18	40	44	0,15	10	70
7R41 0773 11	25 x 1/2	34	32	51	16	38	36	0,094	10	70
7R41 0775 11	25 x 3/4	34	32	54	16	40	44	0,12	10	70
7R41 0875 11	32 x 3/4	43	38	60	20	45	44	0,14	5	50
7R41 0876 11	32 x 1	43	38	65	20	49	51	0,21	10	60

BR PP-RCT-LFB Ü-T-Stück 90° **IG-NPT** grün

BR PP-RCT-LFB Transition-Tee 90° **female-thread-NPT** green

Art Nr	d x NPT	D	l1	l2	z1	z2	SW	KG	VE1	VE2
Art No	[mm x Inch]	[mm]							PU1	PU2
7L41 0643 U1	20 x 1/2	29	28	36	13	22	36	0,096	10	60
7L41 0645 U1	20 x 3/4	34	32	40	17	26	44	0,110	10	40
7L41 0743 U1	25 x 1/2	34	32	38	16	24	36	0,078	10	50
7L41 0745 U1	25 x 3/4	34	32	40	16	26	44	0,10	10	40
7L41 0845 U1	32 x 3/4	43	38	45	20	31	44	0,12	5	30
7L41 0846 U1	32 x 1	43	38	48	20	31	51	0,17	5	30

BR PP-RCT-LFB Ü-T-Stück 90° **AG-NPT** grün

BR PP-RCT-LFB Transition-Tee 90° **male-thread-NPT** green

Art Nr	d x NPT	D	l1	l2	z1	z2	SW	KG	VE1	VE2
Art No	[mm x Inch]	[mm]							PU1	PU2
7L41 0673 U1	20 x 1/2	29	32	50	17	36	36	0,086	10	60
7L41 0675 U1	20 x 3/4	34	32	57	17	42	44	0,150	10	70
7L41 0773 U1	25 x 1/2	34	32	54	16	40	36	0,094	10	70
7L41 0775 U1	25 x 3/4	34	32	57	16	42	44	0,12	10	70
7L41 0875 U1	32 x 3/4	43	38	62	20	47	44	0,14	5	50
7L41 0876 U1	32 x 1	43	38	65	20	46	51	0,21	10	60

4.02.05 Übergänge Wand • Transitions wall

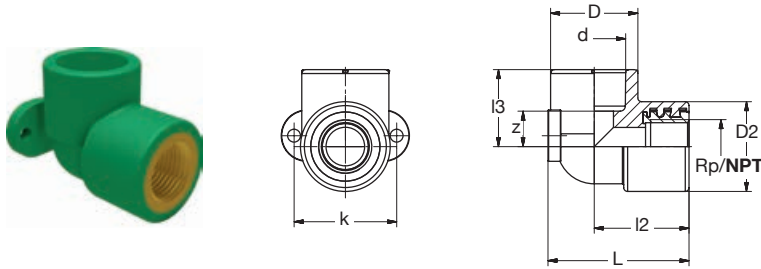

BR PP-RCT-RG Ü-Winkel 90° Wandbefestigung **IG-zyl** grün

BR PP-RCT-Bronze Transition-Elbow 90° wall mount **female-thread-cyl** green

Art Nr	d x Rp	D	D2	L	l2	l3	k	z	KG	VE1	VE2
Art No	[mm x Inch]	[mm]								PU1	PU2
7R31 0643 11	20 x 1/2	29	35	50	35	27	40	13	0,065	10	40
7R31 0743 11	25 x 1/2	34	35	54	37	30	40	14	0,071	10	60
7R31 0745 11	25 x 3/4	43	43	64	43	35	50	19	0,12	10	30
7R31 0845 11	32 x 3/4	43	43	64	43	35	50	17	0,11	10	30

BR PP-RCT-LFB Ü-Winkel 90° Wandbefestigung **IG-NPT** grün

BR PP-RCT-LFB Transition-Elbow 90° wall mount **female-thread-NPT** green

Art Nr	d x NPT	D	D2	L	l2	l3	k	z	KG	VE1	VE2
Art No	[mm x Inch]	[mm]								PU1	PU2
7L31 0643 U1	20 x 1/2	29	35	50	35	27	40	13	0,065	10	40
7L31 0743 U1	25 x 1/2	34	35	54	37	30	40	14	0,071	10	60
7L31 0745 U1	25 x 3/4	43	43	64	43	35	50	19	0,12	10	30
7L31 0845 U1	32 x 3/4	43	43	64	43	35	50	17	0,11	10	30

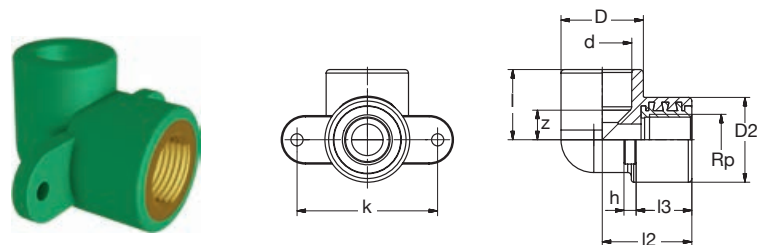

BR PP-RCT-RG Ü-Winkel 90° Hohlwandbefestigung **IG-zyl** grün

BR PP-RCT-Bronze Transition-Elbow 90° hollow wall mount **female-thread-cyl** green

Art Nr	d x Rp	D	D2	l	l2	l3	h	k	z	KG	VE1	VE2
Art No	[mm x Inch]	[mm]									PU1	PU2
7R3H 0643 11	20 x 1/2	29	35	27	34	21	5	59	13	0,064	10	80
7R3H 0743 11	25 x 1/2	34	35	30	37	23	5	59	14	0,071	10	80

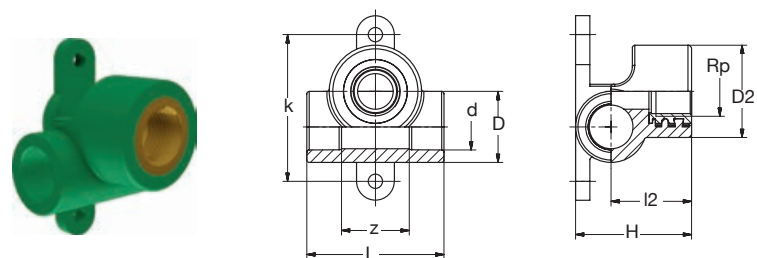

BR PP-RCT-RG Ü-Winkel 90° Durchgang Wandbefestigung **IG-cyl** grün

BR PP-RCT-Bronze Transition-Elbow 90° passage wall mount **female-thread-cyl** green

Art Nr	d x Rp	D	D2	L	L2	H	k	z	KG	VE1	VE2
Art No	[mm x Inch]	[mm]								PU1	PU2
7R3D 0643 21	20 x 1/2	30	39	58	34	49	62	29	0,077	10	40

4.02.05 Übergänge Wand • Transitions wall

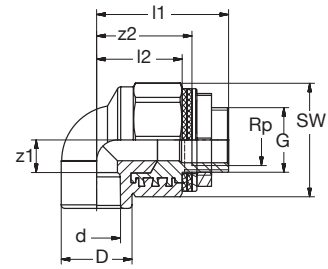
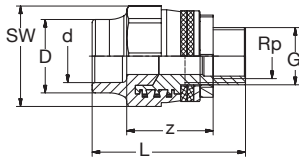

BR PP-RCT-RG Übergang Hohlwandbefestigung IG-zyl grün
BR PP-RCT-Bronze Transition hollow wall mount female-thread-cyl green

BR PP-RCT-RG Ü-Winkel 90 Hohlwandbefestigung IG-zyl grün
BR PP-RCT-Bronze Transition-Elbow 90 hollow wall mount male-thread-cyl green

Art Nr	d x Rp x G	D	L	z	SW	KG	VE1	VE2
Art No	[mm x Inch]	[mm]					PU1	PU2

Art Nr	d x Rp x G	D	l1	l2	z1	z2	SW	KG	VE1	VE2
Art No	[mm x Inch]	[mm]							PU1	PU2

Länge • Length G = 30 mm

7R1L 0645 11 20 x 1/2 x 3/4 43 70 40,5 44 0,24 10 40

Länge • Length G = 30 mm

7R2L 0645 11 20 x 1/2 x 3/4 29 65 35 13,5 50 44 0,25 10 50

Länge • Length G = 19 mm

7R1H 0645 11 20 x 1/2 x 3/4 43 59 29,5 44 0,21 10 40

Länge • Length G = 19 mm

7R2H 0645 11 20 x 1/2 x 3/4 29 54 35 13,5 39 44 0,23 10 50

Komplett mit Kontersatz • Complete with counter set.

Komplett mit Kontersatz • Complete with counter set.

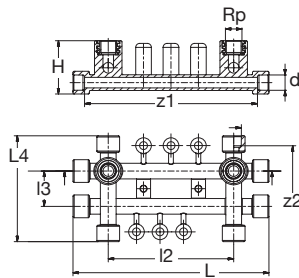

BR PP-RCT-RG Montagegruppe 2 - Kreuz grün
BR PP-RCT-Bronze Mounting group 2 - Cross green

Art Nr	d x Rp	L	l2	l3	L4	H	z1	z2	KG	VE1	VE2
Art No	[mm x Inch]	[mm]								PU1	PU2

7R9K 0643 11 20 x 1/2 250 160 90 135 69 221 106 0,37 1 8

4.02.06 Verschraubungen • Unions

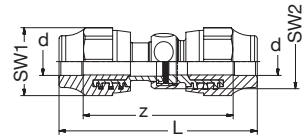
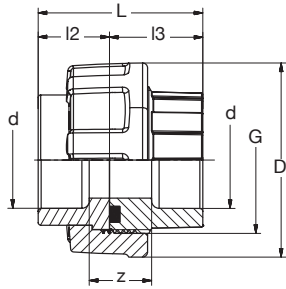

BR PP-RCT Verschraubung Runddichtung-EPDM 20°C/1,0MPa grün
BR PP-RCT Union O-Ring-gasket-EPDM 20°C/1.0MPa green

Art Nr	d	D	G	L	l2	l3	z	KG	VE1	VE2
Art No	[mm]	[mm]	[Zoll/Inch]	[mm]	[mm]	[mm]	[mm]		PU1	PU2
7351 0600 31	20	46	1	44,0	17,5	26	15	0,039	1	150
7351 0700 31	25	56	1 1/4	47,5	19,0	28	15	0,061	1	125
7351 0800 31	32	66	1 1/2	51,5	21,0	30	15	0,091	1	100
7351 0900 31	40	79	2	58,0	23,5	34	17	0,14	1	60
7351 1000 31	50	87	2 1/4	66,0	26,5	39	19	0,17	1	40
7351 1100 31	63	107	2 3/4	78,5	30,5	47	23	0,28	1	30

BR PP-RCT-RG/LFB Verschraubung Flachdichtung-EPDM grün
BR PP-RCT-Bronze/LFB Union flat-gasket-EPDM green

Art Nr	d	L	z	SW1	SW2	KG	VE1	VE2
Art No	[mm]	[mm]	[mm]	[mm]	[mm]		PU1	PU2
Rotguss • Bronze								
7R51 0600 11	20	116	87	44	37	0,25	1	50
7R51 0700 11	25	119	87	44	37	0,39	1	30
7R51 0800 11	32	134	96	51	46	0,58	1	20
7R51 0900 11	40	152	110	63	52	0,98	1	12
7R51 1000 11	50	164	116	70	59	1,20	1	8
7R51 1100 11	63	189	134	85	74	2,10	1	6
7R51 1200 11	75	223	162	115	90	3,75	1	2
7R51 1300 11	90	280	213	135	95	4,21	1	-
LFB								
7L51 0700 11	25	119	83	44	37	0,39	1	30
7L51 0800 11	32	134	96	51	46	0,58	1	20
7L51 0900 11	40	152	110	63	52	0,98	1	12
7L51 1000 11	50	163	115	70	59	1,20	1	8
7L51 1100 11	63	187	131	85	74	2,10	1	6
7L51 1200 11	75	220	160	115	90	3,75	1	2

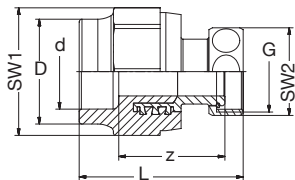

BR PP-RCT-RG/LFB A-Verschraubung IG-zyl für Armaturen + Wasserzähler mit Flachdichtung-EPDM grün

BR PP-RCT-Bronze/LFB Union flat-sealing for Valves + Water meters female-thread-cyl with flat-gasket-EPDM green

Art Nr	d x G	D	L	z	SW1	SW2	KG	VE1	VE2
Art No	[mm x Inch]	[mm]	[mm]	[mm]	[mm]	[mm]		PU1	PU2
Rotguss • Bronze									
7R51 06A0 11	20 x 3/4	29	66	44	36	30	0,14	1	50
7R51 06A1 11	20 x 1	29	72	44	44	37	0,23	1	30
7R51 07A0 11	25 x 3/4	34	67	44	44	30	0,13	1	50
7R51 07A1 11	25 x 1	34	72	47	44	37	0,20	1	30
7R51 08A0 11	32 x 1	43	80	53	51	37	0,19	1	20
7R51 08A1 11	32 x 1 1/4	43	80	53	51	46	0,32	1	20
7R51 09A0 11	40 x 1 1/4	55	86	56	63	46	0,36	1	12
7R51 09A1 11	40 x 1 1/2	55	90	58	63	52	0,57	1	12
7R51 10A0 11	50 x 1 3/4	64	98	61	70	59	0,62	1	8
7R51 11A0 11	63 x 2 3/8	79	114	71	85	74	1,08	1	6
7R51 12A0 11	75 x 2 3/4	99	137	86	112	90	1,91	1	2
7R51 13A0 11	90 x 3 1/2	118	167	118	134	109	2,49	1	2
LFB									
7L51 07A1 11	25 x 1	34	72	47	44	37	0,20	1	30
7L51 08A1 11	32 x 1 1/4	43	80	53	51	46	0,32	1	20
7L51 09A1 11	40 x 1 1/2	52	90	58	63	52	0,57	1	12
7L51 10A0 11	50 x 1 3/4	64	98	61	70	59	0,62	1	8
7L51 11A0 11	63 x 2 3/8	79	114	71	85	74	1,08	1	6
7L51 12A0 11	75 x 2 3/4	99	131	86	113	90	1,91	1	2

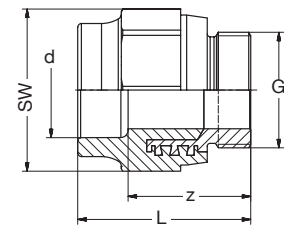

BR PP-RCT-RG/LFB Verschraubung Schraubteil flachdichtend grün
BR PP-RCT-Bronze/LFB Union Srew-part flat-sealing green

Art Nr	d x G	L	z	SW	KG	VE1	VE2
Art No	[mm x Inch]	[mm]	[mm]	[mm]		PU1	PU2
Rotguss • Bronze							
7R51 06S0 11	20 x 3/4	50	34	36	0,11	1	50
7R51 06S1 11	20 x 1	53	38	44	0,14	1	30
7R51 07S0 11	25 x 3/4	51	35	36	0,11	1	30
7R51 07S1 11	25 x 1	54	38	44	0,14	1	30
7R51 08S1 11	32 x 1 1/4	62	43	51	0,26	1	20
7R51 09S1 11	40 x 1 1/2	72	51	63	0,45	1	12
7R51 10S0 11	50 x 1 3/4	77	53	70	0,51	1	8
7R51 11S0 11	63 x 2 3/8	88	60	85	0,75	1	6
7R51 12S0 11	75 x 2 3/4	104	74	115	1,50	1	4
7R51 13S0 11	90 x 3 1/2	132	99	135	2,33	1	2
LFB							
7L51 07S1 11	25 x 1	54	38	44	0,14	1	30
7L51 08S1 11	32 x 1 1/4	62	43	51	0,26	1	20
7L51 09S1 11	40 x 1 1/2	72	51	63	0,45	1	12
7L51 10S0 11	50 x 1 3/4	77	53	70	0,51	1	8
7L51 11S0 11	63 x 2 3/8	88	60	85	0,75	1	6
7L51 12S0 11	75 x 2 3/4	104	74	115	1,50	1	4

4.02.06 Verschraubungen • Unions

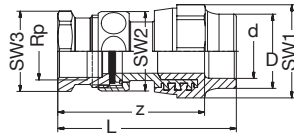

BR PP-RCT-RG Ü-Verschraubung IG-zyl Flachdichtring-EPDM grün

BR PP-RCT-Bronze Transition-Union female-thread-cyl flat-gasket-EPDM green

Art Nr	d x Rp	G	D	L	z	SW1	SW2	SW3	KG	VE1	VE2
Art No	[mm x Inch]	[Inch]	[mm]							PU1	PU2
7R51 0643 11	20 x 1/2	3/4	29	85	70	36	30	27	0,19	1	50
7R51 0645 11	20 x 3/4	1	29	93	78	44	37	34	0,34	1	30
7R51 0743 11	25 x 1/2	3/4	34	87	71	36	30	27	0,19	1	50
7R51 0745 11	25 x 3/4	1	34	95	79	44	37	34	0,30	1	30
7R51 0845 11	32 x 3/4	1	43	97	79	44	37	34	0,34	1	20
7R51 0846 11	32 x 1	1 1/4	43	103	85	51	46	44	0,51	1	20
7R51 0947 11	40 x 1 1/4	1 1/2	52	115	94	63	52	50	0,66	1	12
7R51 1048 11	50 x 1 1/2	1 3/4	64	126	102	70	59	55	0,82	1	8
7R51 1150 11	63 x 2	2 3/8	79	142	114	85	74	70	1,30	1	3
7R51 1253 11	75 x 2 1/2	2 3/4	99	169	139	113	90	90	2,39	1	2

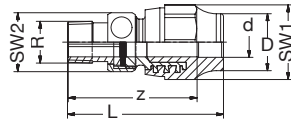

BR PP-RCT-RG Ü-Verschraubung AG-keg FD-EPDM grün

BR PP-RCT-Bronze Transition-Union male-thread-con flat-gasket-EPDM green

Art Nr	d x R	G	D	L	z	SW1	SW2	KG	VE1	VE2	
Art No	[mm x Inch]	[Inch]	[mm]							PU1	PU2
7R51 0673 11	20 x 1/2	3/4	29	79	65	36	30	0,18	1	50	
7R51 0675 11	20 x 3/4	1	29	86	72	44	37	0,28	1	30	
7R51 0773 11	25 x 1/2	3/4	34	81	65	36	30	0,16	1	50	
7R51 0775 11	25 x 3/4	1	34	88	72	44	37	0,27	1	30	
7R51 0875 11	32 x 3/4	1	43	81	63	44	37	0,29	1	20	
7R51 0876 11	32 x 1	1 1/4	43	98	80	51	46	0,42	1	20	
7R51 0977 11	40 x 1 1/4	1 1/2	52	113	92	63	52	0,59	1	12	
7R51 1078 11	50 x 1 1/2	1 3/4	64	119	96	70	59	0,73	1	8	
7R51 1180 11	63 x 2	2 3/8	79	137	109	85	74	1,30	1	3	
7R51 1283 11	75 x 2 1/2	2 3/4	99	175	145	113	90	2,88	1	2	

4.02.06 Verschraubungen • Unions

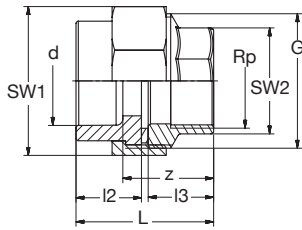

BR PP-RCT-V2A Ü-Verschraubung IG-zyl Flachdichtring-EPDM 20°C/1,0MPa grün

BR PP-RCT-Stainless steel Transition-Union female-thread-cyl flat-gasket-EPDM 20°C/1.0MPa green

Art Nr	d x Rp	DN	G	L	l2	l3	z	SW1	SW2	KG	VE1
Art No	[mm x Inch]	[mm]	[Inch]	[mm]							PU1
7V51 0643 11	20 x 1/2	15	1	49	21	25	34	38	27	0,13	1
7V51 0745 11	25 x 3/4	20	1 1/4	52	21	28	36	47	32	0,22	1
7V51 0846 11	32 x 1	25	1 1/2	57	23	31	39	52	38	0,28	1
7V51 0947 11	40 x 1 1/4	32	2	62	26	33	41	66	47	0,46	1
7V51 1048 11	50 x 1 1/2	40	2 1/4	68	29	36	44	72	53	0,56	1
7V51 1150 11	63 x 2	50	2 3/4	78	33	42	50	87	65	0,93	1

V2A = 1.4305

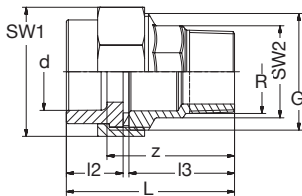

BR PP-RCT-V2A Ü-Verschraubung AG-keg Flachdichtring-EPDM 20°C/1,0MPa grün

BR PP-RCT-Stainless steel Transition-Union male-thread-con flat-gasket-EPDM 20°C/1.0MPa green

Art Nr	d x Rp	DN	G	L	l2	l3	z	SW1	SW2	KG	VE1
Art No	[mm x Inch]	[mm]	[Inch]	[mm]							PU1
7V51 0673 11	20 x 1/2	15	1	68	21	43	52	38	27	0,16	1
7V51 0775 11	25 x 3/4	20	1 1/4	73	21	49	58	47	27	0,26	1
7V51 0876 11	32 x 1	25	1 1/2	79	23	53	61	52	34	0,35	1
7V51 0977 11	40 x 1 1/4	32	2	87	26	58	82	66	43	0,56	1
7V51 1078 11	50 x 1 1/2	40	2 1/4	94	29	62	89	72	50	0,71	1
7V51 1180 11	63 x 2	50	2 3/4	107	33	71	102	87	61	1,06	1

V2A = 1.4305

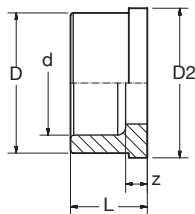

BR PP-RCT Verschraubung Einlegeteil grün

BR PP-RCT Union Insert-part green

Art Nr	d	D	D2	L	z	KG	VE1	VE2
Art No	[mm]	[mm]		[mm]			PU1	PU2
7351 06E0 11	20	27,5	30,0	21	6	0,006	10	250
7351 07E0 11	25	36	38,5	21	6	0,012	10	150
7351 08E0 11	32	41,5	44,7	23	6	0,014	10	200
7351 09E0 11	40	53	56,5	28	7	0,029	10	120
7351 10E0 11	50	59	62,6	32	8	0,036	5	80
7351 11E0 11	63	74	78,5	42	13	0,063	1	75
7351 12E0 11	75	90	97,2	35	5	0,081	1	40

4.02.07 Flanschverbindung • Flange connection

Flanschadapter Muffe (Bundbuchse) in gerillter Ausführung für den Einsatz von Flachdichtungen.

Weitere Informationen zu Flanschen und Dichtungen finden Sie unter Zubehör.

Flange adaptor socket grooved for the use of flat gaskets.

More information about flanges and gaskets see Accessories.

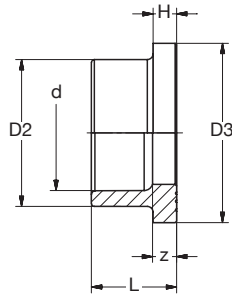
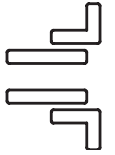

BR PP-RCT Bundbuchse gerillt grün

BR PP-RCT Flange adaptor socket grooved green

Art Nr	d	D2	D3	L	H	z	KG	VE1	VE2
Art No	[mm]	[mm]						PU1	PU2
7331 09F0 11	40	50	61	29	8	9	0,027	10	100
7331 10F0 11	50	61	74	27	8	4	0,043	10	70
7331 11F0 11	63	76	102	40	17	13	0,11	1	24
7331 12F0 11	75	90	122	38	19	8	0,16	1	16
7331 13F0 11	90	108	137	45	21	12	0,25	1	10
7331 14F0 11	110	131	158	50	21	13	0,30	1	15
7331 15F0 11	125	146	162	53	25	13	0,50	1	10

Zubehör Flanschverbindung B-Buchse PP-RCT Accessories Flange Connection socket PP-RCT



Losflansch
Flange loose



Blindflansch
Flange blind



Flachdichtring mit Stahl-Einlage
Flat gasket with steel-inlay

d [mm]	DN [mm]	PP-St		PP-GGG	PP-St	PP-St	
		DIN/EN		ANSI		DIN/EN	ANSI
		PN10/16		150 lbs		PN10/16	150 lbs
40	32	9141 09E1 15			9141 09A2 38	9144 09E1 35	9144 09A2 38
50	40	9141 10E1 15			9141 10A2 38	9144 10E1 35	9144 10A2 38
63	50	9141 11E1 15		9151 11A2 25		9144 11E1 35	9144 11A2 38
75	65	9141 12E1 15			9141 12A2 38	9144 12E1 35	9144 12A2 38
90	80	9142 13E1 15			9141 13A2 38	9144 13E1 35	9144 13A2 38
110	100	9142 14E1 15		9152 14A2 25		9144 14E1 35	9144 14A2 38
125	100	9142 15E1 15				9144 14E1 35	

EPDM-St		NBR-St	
Wasser/Water		Gas/Gas	
PN10			
9202 09F1 35		9202 09F2 35	
9202 10F1 35		9202 10F2 35	
9202 11F1 35		9202 11F2 35	
9202 12F1 35		9202 12F2 35	
9202 13F1 35		9202 13F2 35	
9202 14F1 35		9202 14F2 35	
9202 15F1 35		9202 15F2 35	

4.02.08 Einschweißsättel • Weld-in-saddles

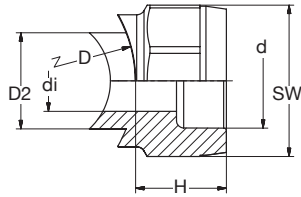

Schweiß- werkzeug Welding tool	BR PP-RCT Einschweißsattel Muffe grün		BR PP-RCT Weld-in-saddle socket green						
	Art Nr Art No	D Rohr/Pipe x d [mm]	D2*	di	H	SW	KG	VE1 PU1	VE2 PU2
①	7571 0906 11	40-50 x 20	25	15	29	38	0,024	10	120
①	7571 0907 11	40-50 x 25	25	15	29	38	0,021	10	120
③	7571 1106 11	63-125 x 20	25	15	29	38	0,025	10	120
③	7571 1107 11	63-125 x 25	25	15	29	38	0,022	10	120
④	7571 1108 11	63-125 x 32	32	20,5	35	51	0,035	10	50
⑤	7571 1209 11	75-125 x 40	40	25,5	38	63	0,083	10	30
⑥	7571 1310 11	90-125 x 50	50	32	39	70	0,098	10	24
⑦	7571 1411 11	110-125 x 63	63	40	45	85	0,163	10	18
⑧	7571 1706 11	160-250 x 20	25	15	29	38	0,027	10	120
⑧	7571 1707 11	160-250 x 25	25	15	29	38	0,024	10	120
⑨	7571 1708 11	160-250 x 32	32	20,5	35	51	0,037	10	50
⑩	7571 1709 11	160-250 x 40	40	25,5	38	63	0,082	10	30
⑪	7571 1710 11	160-250 x 50	50	32	39	70	0,097	10	24
⑫	7571 1711 11	160-250 x 63	63	40	45	85	0,162	10	18
⑭	7571 2308 11	315-630 x 32	32	20,5	35	51	0,086	10	50
⑮	7571 2309 11	315-630 x 40	40	25,5	38	63	0,093	10	30
⑯	7571 2310 11	315-630 x 50	50	32	39	70	0,097	10	24
⑰	7571 2311 11	315-630 x 63	63	40	45	85	0,161	10	18

* D2 = Durchmesser Schweißstutzen / Bohrloch.
D2 = Diameter welding stub / drill hole.

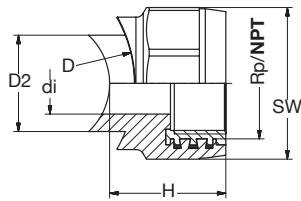

Schweiß- werkzeug Welding tool	BR PP-RCT- RG Ü-Einschweißsattel IG-zyl grün									
	BR PP-RCT- Bronze Transition-Weld-in-saddle female-thread-cyl green									
	Art Nr	D Rohr/Pipe x Rp	D2*	di	H	SW	KG	VE1	VE2	
	Art No	[mm x Inch]	[mm]					PU1	PU2	
①	7R71 0943 11	40-50 x 1/2	25	15	29	38	0,07	10	100	
②	7R71 1143 11	63-125 x 1/2	25	15	29	38	0,07	10	100	
④	7R71 1145 11	63-125 x 3/4	32	20,5	35	51	0,11	10	60	
⑤	7R71 1246 11	75-125 x 1	40	25,5	38	63	0,17	10	30	
⑥	7R71 1347 11	90-125 x 1 1/4	50	32	39	70	0,25	10	30	
⑥	7R71 1348 11	90-125 x 1 1/2	50	34	39	70	0,22	10	24	
⑦	7R71 1450 11	110-125 x 2	63	40	45	85	0,46	10	18	
⑧	7R71 1743 11	160-250 x 1/2	25	15	29	38	0,07	10	100	
⑨	7R71 1745 11	160-250 x 3/4	32	20,5	35	51	0,11	10	60	
⑩	7R71 1746 11	160-250 x 1	40	25,5	38	63	0,17	10	30	
⑪	7R71 1747 11	160-250 x 1 1/4	50	32	39	70	0,24	10	24	
⑪	7R71 1748 11	160-250 x 1 1/2	50	34	39	70	0,24	10	24	
⑫	7R71 1750 11	160-250 x 2	63	40	45	85	0,49	10	18	
⑭	7R71 2345 11	315-630 x 3/4	32	20,5	35	51	0,24	10	60	
⑮	7R71 2346 11	315-630 x 1	40	25,5	38	63	0,24	10	30	
⑮	7R71 2347 11	315-630 x 1 1/4	50	32	39	70	0,25	10	30	
⑮	7R71 2348 11	315-630 x 1 1/2	50	34	39	70	0,24	10	24	
⑰	7R71 2350 11	315-630 x 2	63	40	45	85	0,48	10	18	

* D2 = Durchmesser Schweißstutzen / Bohrloch.
D2 = Diameter welding stub / drill hole.

Schweiß- werkzeug Welding tool	BR PP-RCT- LFB Einschweißsattel IG-NPT grün									
	BR PP-RCT- LFB Weld-in-saddle female-thread-NPT green									
	Art Nr	D Rohr/Pipe x NPT	D2*	di	H	SW	KG	VE1	VE2	
	Art No	[mm x Inch]	[mm]					PU1	PU2	
①	7L71 0943 U1	40-50 x 1/2	25	15	29	38	0,060	10	100	
③	7L71 1143 U1	63-125 x 1/2	25	15	29	38	0,060	10	100	
④	7L71 1145 U1	63-125 x 3/4	32	20,5	35	51	0,105	10	60	
⑤	7L71 1246 U1	75-125 x 1	40	25,5	38	63	0,138	10	30	
⑧	7L71 1743 U1	160-250 x 1/2	25	15	29	38	0,062	10	100	
⑨	7L71 1745 U1	160-250 x 3/4	32	20,5	35	51	0,105	10	60	
⑩	7L71 1746 U1	160-250 x 1	40	25,5	38	63	0,138	10	30	
⑭	7L71 2345 U1	315-630 x 3/4	32	20,5	35	51	0,105	10	60	
⑮	7L71 2346 U1	315-630 x 1	40	25,5	38	63	0,135	10	30	

* D2 = Durchmesser Schweißstutzen / Bohrloch.
D2 = Diameter welding stub / drill hole.

4.02.08 Einschweißsättel • Weld-in-saddles

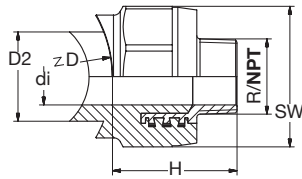

Schweiß- werkzeug Welding tool	BR PP-RCT- RG Ü-Einschweißsattel AG-keg grün BR PP-RCT- Bronze Transition-Weld-in-saddle male-thread-con green								
	Art Nr Art No	D Rohr/Pipe x R [mm x Inch]	D2* [mm]	di	H	SW	KG	VE1 PU1	VE2 PU2
①	7R71 0973 11	40-50 x 1/2	25	15	42	38	0,09	10	80
②	7R71 1173 11	63-125 x 1/2	25	15	42	38	0,09	10	80
④	7R71 1175 11	63-125 x 3/4	32	20,5	49	51	0,13	10	40
⑤	7R71 1276 11	75-125 x 1	40	25,5	54	63	0,21	10	24
⑥	7R71 1377 11	90-125 x 1 1/4	50	32	59	70	0,34	10	24
⑥	7R71 1378 11	90-125 x 1 1/2	50	34	59	70	0,35	10	18
⑦	7R71 1480 11	110-125 x 2	63	40	68	85	0,65	10	18
⑧	7R71 1773 11	160-250 x 1/2	25	15	42	38	0,09	10	80
⑨	7R71 1775 11	160-250 x 3/4	32	20,5	49	51	0,13	10	40
⑩	7R71 1776 11	160-250 x 1	40	25,5	54	63	0,22	10	40
⑪	7R71 1777 11	160-250 x 1 1/4	50	32	59	70	0,33	10	18
⑪	7R71 1778 11	160-250 x 1 1/2	50	34	59	70	0,35	10	18
⑫	7R71 1780 11	160-250 x 2	63	40	68	85	0,73	10	12
⑭	7R71 2375 11	315-630 x 3/4	32	20,5	49	51	0,12	10	40
⑮	7R71 2376 11	315-630 x 1	40	25,5	54	63	0,24	10	40
⑮	7R71 2377 11	315-630 x 1 1/4	50	32	59	70	0,34	10	22
⑮	7R71 2378 11	315-630 x 1 1/2	50	34	59	70	0,35	10	18
⑰	7R71 2380 11	315-630 x 2	63	40	68	85	0,65	10	12

* D2 = Durchmesser Schweißstutzen / Bohrloch.
D2 = Diameter welding stub / drill hole.

Schweiß- werkzeug Welding tool	BR PP-RCT- LFB Einschweißsattel AG-NPT grün BR PP-RCT- LFB Weld-in-saddle male-thread-NPT green								
	Art Nr Art No	D Rohr/Pipe x NPT [mm x Inch]	D2* [mm]	di	H	SW	KG	VE1 PU1	VE2 PU2
①	7L71 0973 U1	40-50 x 1/2	25	15	42	38	0,075	10	80
②	7L71 1173 U1	63-125 x 1/2	25	15	42	38	0,073	10	80
④	7L71 1175 U1	63-125 x 3/4	32	20,5	49	51	0,116	10	40
⑤	7L71 1276 U1	75-125 x 1	40	25,5	54	63	0,170	10	24
⑧	7L71 1773 U1	160-250 x 1/2	25	15	42	38	0,078	10	80
⑨	7L71 1775 U1	160-250 x 3/4	32	20,5	49	51	0,116	10	40
⑩	7L71 1776 U1	160-250 x 1	40	25,5	54	63	0,171	10	40
⑭	7L71 2375 U1	315-630 x 3/4	32	20,5	49	51	0,115	10	40
⑮	7L71 2376 U1	315-630 x 1	40	25,5	54	63	0,169	10	40

* D2 = Durchmesser Schweißstutzen / Bohrloch.
D2 = Diameter welding stub / drill hole.

4.02.09 Verteiler • Manifolds

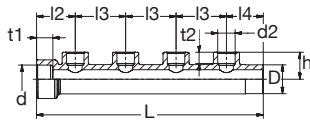

BR PP-RCT Verteiler Muffe kaskadierbar grün

BR PP-RCT Manifold socket cascadable green

Art Nr	d/D - d2 x n	L	l2	l3	l4	t1	t2	h	KG	VE1	VE2
Art No	[mm]	[mm]								PU1	PU2
7584 0806 11	32 - 20 x 4	245	43	56	37	18	14,5	30	0,13	1	20
7584 0807 11	32 - 25 x 4	250	43	56	41	18	16	35	0,15	1	30
7584 0907 11	40 - 25 x 4	248	43	56	41	20,5	16	38	0,21	1	20

n = Anzahl der Abgänge • Number of outlets.

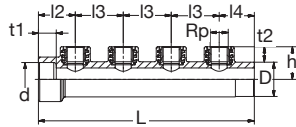

BR PP-RCT-RG Verteiler IG-zyl kaskadierbar grün

BR PP-RCT-RB Manifold female-thread-cyl cascadable green

Art Nr	d/D x Rp x n	L	l2	l3	l4	t1	t2	h	KG	VE1	VE2
Art No	[mm]	[mm]								PU1	PU2
7R84 0843 11	32 x 1/2 x 4	250	43	56	41	18	14	35	0,35	1	40
7R84 0943 11	40 x 1/2 x 4	250	43	56	41	20,5	14	38	0,40	1	25
7R82 1145 11	63 x 3/4 x 2	434	148	204	82	27,5	15	59	0,74	1	15

n = Anzahl der Abgänge • Number of outlets.

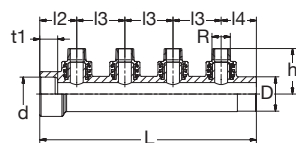
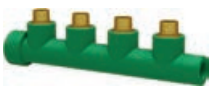

BR PP-RCT-RG Verteiler AG-keg kaskadierbar grün

BR PP-RCT-RB Manifold male-thread-con cascadable green

Art Nr	d/D x Rp x n	L	l2	l3	l4	t1	t2	h	KG	VE1	VE2
Art No	[mm]	[mm]								PU1	PU2
7R84 0873 11	32 x 1/2 x 4	250	43	56	41	18	14	50	0,43	1	25
7R84 0973 11	40 x 1/2 x 4	250	43	56	41	20,5	14	53	0,47	1	20
7R82 1175 11	63 x 3/4 x 2	434	148	204	82	27,5	15	75	0,46	1	15

n = Anzahl der Abgänge • Number of outlets.

4.02.10 Kugelhähne • Ball valves

Weitere Dimensionen und Modelle siehe Kapitel PPR.
Other dimensions and models see chapter PPR.

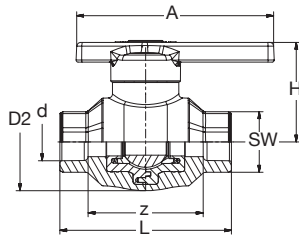

BR PP-RCT Kugelhahn 20°C/1,0MPa grün
BR PP-RCT Ball valve 20°C/1.0MPa green

Art Nr	d	D2	L	H	A	SW	z	KG	VE1	VE2
Art No	[mm]								PU1	PU2
7911 0600 11	20	50	88	51	100	31	59,0	0,15	1	50
7911 0700 11	25	55	92	54	100	38	59,6	0,17	1	48
7911 0800 11	32	66	99	58	100	46	64,0	0,23	1	30
7911 0900 11	40	90	115	76	144	54	73,4	0,52	1	15
7911 1000 11	50	104	124	82	144	66	76,5	0,65	1	12
7911 1100 11	63	115	150	90	144	82	94,6	0,83	1	6

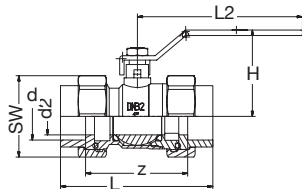

BR PP-RCT Kugelhahn-Ms verschraubt Runddichtring-EPDM grün
BR PP-RCT Ball valve Brass with union-nuts O-Ring-gasket-EPDM green

Art Nr	d	d2	L	L2	H	z	SW	KG	VE1	VE2
Art No	[mm]								PU1	PU2
7MKV 0600 21	20	15	85	87	41	55	37	0,33	1	-
7MKV 0700 21	25	20	94	87	45	64	46	0,50	1	-
7MKV 0800 21	32	25	103	112	58	69	52	0,71	1	-

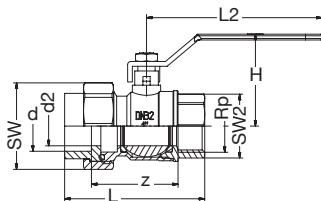

BR PP-RCT Ü-Kugelhahn-Messing IG-zyl verschraubt Runddichtring-EPDM grün
BR PP-RCT Transition-Ball valve Brass female-thread-cyl with union-nuts O-Ring-gasket-EPDM green

Art Nr	dx Rp	d2	L	L2	H	z	SW	SW2	KG	VE1
Art No	[mm x Inch]									PU1
7MKV 0643 21	20 x 1/2	15	71	87	41	42	37	26	0,23	1
7MKV 0745 21	25 x 3/4	20	80	87	45	50	46	32	0,39	1
7MKV 0846 21	32 x 1	25	89	112	58	54	52	38	0,59	1

4.02.11 Ventile • Valves

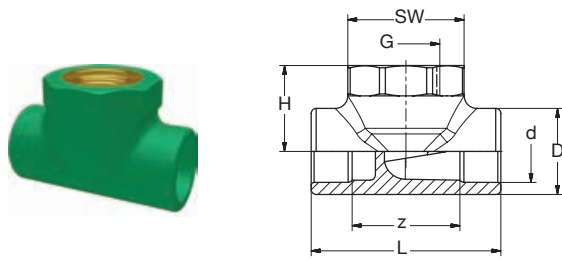

BR PP-RCT-RG Ventil Geradsitz Unterteil IG-zyl grün
BR PP-RCT-Bronze Valve straight bottom part female-thread-cyl green

Art Nr	d x G	D	L	H	z	SW	KG	VE1	VE2
Art No	[mm]	[mm]						PU1	PU2
7RG1 06U0 11	20 x 3/4	29	75	34	46	46	0,110	10	80
7RG1 07U0 11	25 x 3/4	34	75	34	43	46	0,117	10	80
7RG1 08U0 11	32 x 3/4	43	75	34	38	46	0,134	10	80

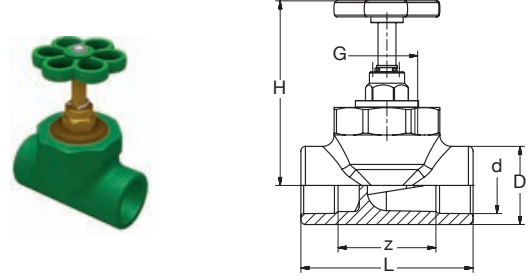

BR PP-RCT-RG Ventil Geradsitz Handrad grün
BR PP-RCT-Bronze Valve straight with hand wheel green

Art Nr	d	D	L	H	z	KG	VE1
Art No	[mm]	[mm]					PU1
7RG1 060H 11	20	29	75	69	46	0,29	1
7RG1 070H 11	25	34	75	69	43	0,29	1
7RG1 080H 11	32	43	75	69	39	0,32	1

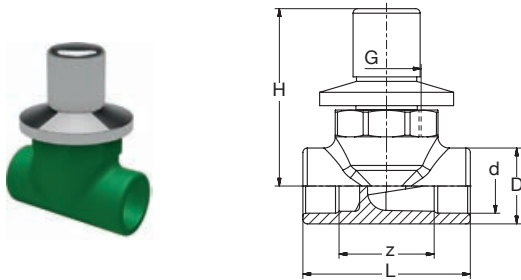

BR PP-RCT Ventil Geradsitz UP mit Flügelrad + Kappe grün
BR PP-RCT Valve straight concealed with winged wheel + cap green

Art Nr	d	D	L	H	z	KG	VE1
Art No	[mm]	[mm]					PU1
7RG1 060K 11	20	29	75	63	46	0,286	1
7RG1 070K 11	25	34	75	63	43	0,275	1
7RG1 080K 11	32	43	75	63	39	0,298	1

Mit verchromter Rosette 70 mm.
With chromed rosette 70 mm.

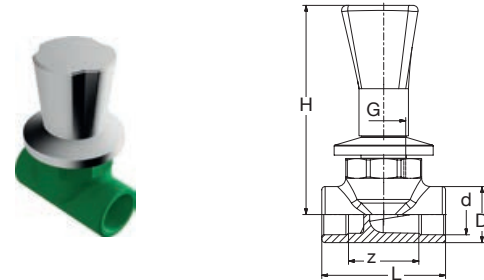

BR PP-RCT Ventil Geradsitz UP mit Drehgriff grün
BR PP-RCT Valve straight concealed with handle bar green

Art Nr	d	D	L	H	z	KG	VE1
Art No	[mm]	[mm]					PU1
7RG1 060G 11	20	29	75	112	46	0,330	1
7RG1 070G 11	25	34	75	112	43	0,332	1
7RG1 080G 11	32	43	75	112	39	0,320	1

Mit verchromter Rosette 70 mm.
With chromed rosette 70 mm.

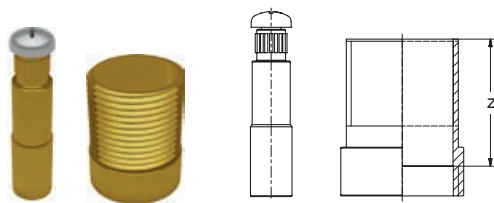

BR Ventil Geradsitz UP Verlängerungsset 30mm
BR Valve straight concealed prolongation-set 30mm

Art Nr	L	KG	VE1
Art No	[mm]		PU1
9902 0004 09	30	0,15	1

Bestehend aus: Gewindehülse, Achsverlängerung und Schraube.
Consists of: threaded sleeve, axle extension and screw.

4.02.11 Ventile • Valves

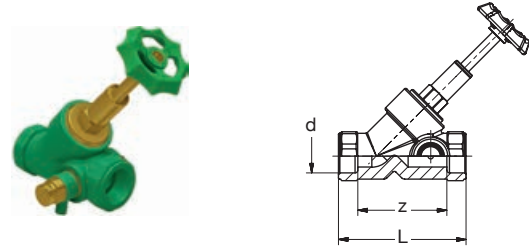
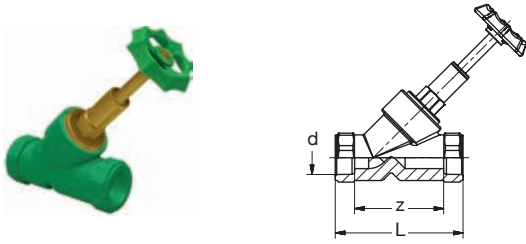

BR PP-RCT-RG Ventil Schrägsitz mit Metallsitz grün
BR PP-RCT-Bronze Valve angle with metal seat green

BR PP-RCT-RG Ventil Schrägsitz mit Metallsitz + Entleerung + Prüfstopfen grün
BR PP-RCT-Bronze Valve angle with metal seat + drainage + test plug green

Art Nr Art No	d [mm]	L [mm]	z [mm]	KG	VE1 PU1
7RS1 0600 11	20	115	86	0,31	1
7RS1 0700 11	25	115	83	0,31	1
7RS1 0800 11	32	120	84	0,49	1
7RS1 0900 11	40	145	104	0,73	1

Art Nr Art No	d [mm]	L [mm]	z [mm]	KG	VE1 PU1
7RS1 060E 11	20	115	86	0,38	1
7RS1 070E 11	25	115	83	0,39	1
7RS1 080E 11	32	120	84	0,56	1
7RS1 090E 11	40	145	104	0,74	1

4.03 Formteile Stumpf-Schweißen • Fittings butt-welding

Beschreibung

Gespitzte Formteile, für die Heizelement-Stumpf-Schweißung und die Heizwendel-Muffen-Schweißung (nur lange Ausführung); ohne Verschwächungsbeiwerte.

Werkstoff

PP-RCT (Polypropylen - Random copolymer, Crystalline structure, Temperature resistant) mit modifizierter Kristallstruktur (beta nukleiert) und erhöhter Temperaturbeständigkeit, Borealis RA7050GN, Farbe RAL 6024 Verkehrsgrün.

Das Material entspricht den Anforderungen der aktuellen KTW-Leitlinie des Umweltbundesamtes (UBA).

Geometrische Eigenschaften

Abmessungen und Toleranzen für Formteile bis D160 entsprechend DIN EN ISO 15874-3.

Abmessungen und Toleranzen für Formteile D200 – 500 entsprechend EN 12201-3. Toleranzen bei den Z-Maßangaben sind abhängig von der Dimension. Bis d/D 160 = +/- 3 mm. Ab d/D 180 = +/- 10 mm.

Betriebsdruck

Der Betriebsdruck richtet sich nach der SDR Klasse und dem eingesetzten Rohr.

Ausführung

Geeignet für Heizelement-Stumpf-Schweißung und Heizwendel-Muffen-Schweißung nach DVS Richtlinie 2207. Schweiß-Geräte und Schweiß-Werkzeuge sollten der DVS Richtlinie 2208 entsprechen.

Zertifizierung

B-R Formteile unterliegen regelmäßigen internen und externen Qualitätskontrollen. Die Formteile erfüllen die Anforderungen der DIN Certco Richtlinie ZP 10.25.1 und NSF14 + 61.

Lieferung

Abgabe erfolgt nur in kompletten Verpackungseinheiten (VE's).

Description

Injection moulded fittings, for butt-welding and electrofusion-socket-welding (only long type); without pressure reduction factors.

Material

PP-RCT (Polypropylene - Random copolymer, Crystalline structure, Temperature resistant) with modified crystalline structure (beta nucleated) and increased temperature resistance, Borealis RA7050GN, colour RAL 6024 traffic green.

The material complies with the requirements of the KTW guideline of the German Federal Environmental Agency (UBA).

Geometric Properties

Dimensions and tolerances for fittings up to D160 according to DIN EN ISO 15874-3. Dimensions and tolerances for fittings D200 – 500 according to EN 12201-3.

Tolerances of z-sizes depend on the dimension. Up to d/D 160 = +/- 3 mm and from d/D 180 = +/- 10 mm.

Operating pressure

The operating pressure depends on the SDR class and the used pipe.

Type

Suitable for butt-welding and electrofusion-socket-welding according to DVS technical code 2207. Welding equipment according to DVS technical code 2208.

Certification

B-R fittings succumb frequent internal and external quality controls. The fittings fulfill the requirements of the DIN Certco guideline ZP 10.25.1 and NSF14 + 61.

Delivery

Supply only in complete packing units (PU's).

4.03.01 Winkel • Elbows

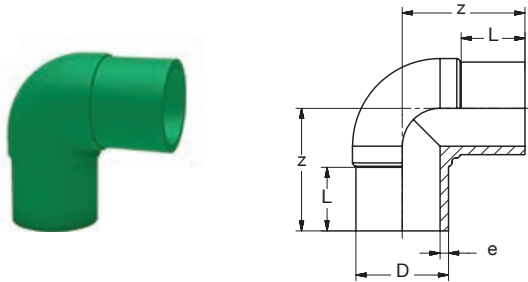

BR PP-RCT Winkel 90° lang st **SDR7,4** grün
BR PP-RCT Elbow 90° long butt **SDR7.4** green

Art Nr	D	e	L	z	KG	VE1	VE2
Art No	[mm]	[mm]	[mm]			PU1	PU2
7418 1790 11	160	21,9	117	210	4,00	1	-

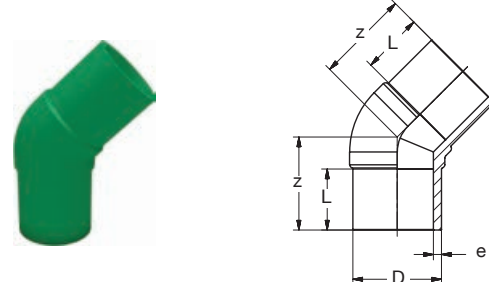

BR PP-RCT Winkel 45° lang st **SDR7,4** grün
BR PP-RCT Elbow 45° long butt **SDR7.4** green

Art Nr	D	e	L	z	KG	VE1	VE2
Art No	[mm]	[mm]	[mm]			PU1	PU2
7418 1745 11	160	21,9	110	169	3,2	1	-

BR PP-RCT Winkel 90° lang st **SDR11** grün
BR PP-RCT Elbow 90° long butt **SDR11** green

Art Nr	D	e	L	z	KG	VE1	VE2
Art No	[mm]	[mm]	[mm]			PU1	PU2
7413 1790 11	160	14,6	117	210	3,0	1	48
7413 1990 11	200	18,2	128	250	5,4	1	24
7413 2190 11	250	22,7	180	307	9,5	1	15
7413 2390 11	315	28,6	192	393	17,7	1	7
7413 2490 11	355	32,2	170	411	28,3	1	5
7413 2590 11	400	36,3	187	470	39,6	1	4
7413 2690 11	450	40,9	204	527	57,0	1	4
7413 2790 11	500	45,4	222	562	75,6	1	2

BR PP-RCT Winkel 45° lang st **SDR11** grün
BR PP-RCT Elbow 45° long butt **SDR11** green

Art Nr	D	e	L	z	KG	VE1	VE2
Art No	[mm]	[mm]	[mm]			PU1	PU2
7413 1745 11	160	14,6	113	169	2,4	1	60
7413 1945 11	200	18,2	127	201	4,4	1	-
7413 2145 11	250	22,7	155	217	8,0	1	18
7413 2345 11	315	28,6	161	280	14,9	1	8
7413 2445 11	355	32,2	170	320	21,9	1	6
7413 2545 11	400	36,3	187	350	30,1	1	4
7413 2645 11	450	40,9	204	383	41,4	1	4
7413 2745 11	500	45,4	220	410	54,9	1	2

BR PP-RCT Winkel 90° lang st **SDR17** grün
BR PP-RCT Elbow 90° long butt **SDR17** green

Art Nr	D	e	L	z	KG	VE1	VE2
Art No	[mm]	[mm]	[mm]			PU1	PU2
7414 1790 11	160	9,5	117	210	2,33	1	48
7414 1990 11	200	11,9	128	250	4,34	1	24
7414 2190 11	250	14,8	180	307	7,62	1	15

BR PP-RCT Winkel 45° lang st **SDR17** grün
BR PP-RCT Elbow 45° long butt **SDR17** green

Art Nr	D	e	L	z	KG	VE1	VE2
Art No	[mm]	[mm]	[mm]			PU1	PU2
7414 1745 11	160	9,5	113	169	1,97	1	60
7414 1945 11	200	11,9	127	201	3,62	1	-
7414 2145 11	250	14,8	155	217	6,12	1	18

4.03.02 T-Stücke • Tee's

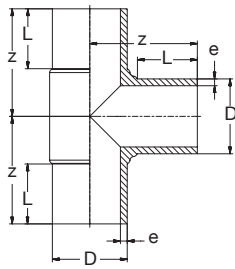

BR PP-RCT T-Stück 90° lang st **SDR11** grün
BR PP-RCT Tee 90° long butt **SDR11** green

Art Nr Art No	D [mm]	e	L	z	KG	VE1 PU1	VE2 PU2
7513 1790 11	160	14,6	124	225	4,01	1	38
7513 1990 11	200	18,2	127	251	7,30	1	15
7513 2190 11	250	22,7	148	314	13,8	1	13
7513 2390 11	315	28,6	165	357	27,6	1	5
7513 2490 11	355	32,2	170	392	34,7	1	4
7513 2590 11	400	36,3	187	435	50,0	1	4
7513 2690 11	450	40,9	204	480	70,0	1	3
7513 2790 11	500	45,4	220	523	90,0	1	2

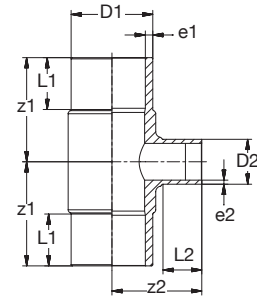

BR PP-RCT T-Stück 90° red lang st **SDR11** grün
BR PP-RCT Tee 90° red long butt **SDR11** green

Art Nr Art No	D1 - D2 [mm]	e1	e2	L1	L2	z1	z2	KG	VE1 PU1	VE2 PU2
7523 1713 11	160 - 90	14,6	8,2	111	84	212	190	3,53	1	40
7523 1714 11	160 - 110	14,6	10,0	111	93	212	197	3,56	1	40
7523 1913 11	200 - 90	18,2	8,2	128	88	258	213	6,17	1	22
7523 1914 11	200 - 110	18,2	10,0	128	98	258	224	6,28	1	20
7523 1915 11	200 - 125	18,2	11,4	128	104	258	226	6,37	1	21
7523 1917 11	200 - 160	18,2	14,6	128	112	258	242	6,70	1	16

BR PP-RCT T-Stück 90° lang st **SDR17** grün
BR PP-RCT Tee 90° long butt **SDR17** green

Art Nr Art No	D [mm]	e	L	z	KG	VE1 PU1	VE2 PU2
7514 1790 11	160	9,5	124	225	3,84	1	38
7514 1990 11	200	11,9	127	251	6,65	1	15
7514 2190 11	250	14,8	148	314	13,4	1	13

BR PP-RCT T-Stück 90° red lang st **SDR17-11** grün
BR PP-RCT Tee 90° red long butt **SDR17-11** green

Art Nr Art No	D1 - D2 [mm]	e1	e2*	L1	L2	z1	z2	KG	VE1 PU1	VE2 PU2
7524 1713 11	160 - 90	9,5	8,2	111	84	212	190	2,92	1	40
7524 1913 11	200 - 90	11,9	8,2	128	88	258	213	5,22	1	22
7524 1914 11	200 - 110	11,9	10,0	128	98	258	224	5,25	1	20

* Abgang • Outlet SDR11

4.03.03 Reduktionen, Kappen • Reducers, Caps

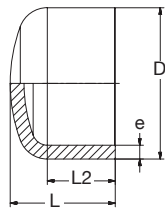

BR PP-RCT Kappe lang st **SDR7,4** grün
BR PP-RCT Cap long butt **SDR7,4** green

Art Nr Art No	D [mm]	e	L	l2	KG	VE1 PU1	VE2 PU2
7348 1700 11	160	21,9	140	100	1,30	1	-

BR PP-RCT Kappe lang st **SDR11** grün
BR PP-RCT Cap long butt **SDR11** green

Art Nr Art No	D [mm]	e	L	l2	KG	VE1 PU1	VE2 PU2
7343 1700 11	160	14,6	140	100	0,91	1	210
7343 1900 11	200	18,2	190	145	2,04	1	96
7343 2100 11	250	22,7	218	163	3,17	1	48
7343 2300 11	315	28,6	250	192	5,92	1	30
7343 2400 11	355	32,2	275	215	8,39	1	18
7343 2500 11	400	36,3	283	228	11,7	1	18
7343 2600 11	450	40,9	306	195	16,5	1	9
7343 2700 11	500	45,4	335	212	23,3	1	6

BR PP-RCT Kappe lang st **SDR17** grün
BR PP-RCT Cap long butt **SDR17** green

Art Nr Art No	D [mm]	e	L	l2	KG	VE1 PU1	VE2 PU2
7344 1700 11	160	9,5	140	100	0,89	1	-
7344 1900 11	200	11,9	190	145	1,89	1	-
7344 2100 11	250	14,8	218	163	2,85	1	-
7344 2300 11	315	18,7	250	192	5,64	1	-



4.03.03 Reduktionen, Kappen • Reducers, Caps

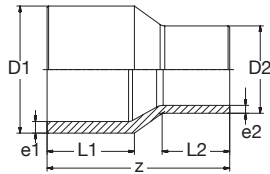

BR PP-RCT Reduktion lang st **SDR7,4** grün

BR PP-RCT Reducer long butt **SDR7.4** green

Art Nr	D1-D2	e1	e2	L1	L2	z	KG	VE1	VE2
Art No	[mm]	[mm]		[mm]			PU1	PU2	
7328 1514 11	125-110	17,1	15,1	100	85	225	1,03	1	190
7328 1714 11	160-110	21,9	15,1	110	85	230	1,52	1	-
7328 1917 21	200-160	27,4	21,9	142	110	300	4,20	1	-
7328 2119 21	250-200	34,2	27,4	140	125	338	6,20	1	-

BR PP-RCT Reduktion lang st **SDR11** grün

BR PP-RCT Reducer long butt **SDR11** green

Art Nr	D1-D2	e1	e2	L1	L2	z	KG	VE1	VE2
Art No	[mm]	[mm]		[mm]			PU1	PU2	
7323 1714 11	160-110	14,6	10,0	110	93	255	1,15	1	175
7323 1715 11	160-125	14,6	11,4	113	95	260	1,12	1	175
7323 1914 21	200-110	18,2	10,0				1,10	1	-
7323 1917 11	200-160	18,2	14,6	142	117	303	2,61	1	62
7323 2117 11	250-160	22,7	14,6	138	111	339	3,95	1	36
7323 2119 11	250-200	22,7	18,2	140	130	340	4,45	1	36
7323 2321 11	315-250	28,6	22,7	160	145	400	7,85	1	27
7323 2421 11	355-250	32,2	22,7	177	150	425	10,1	1	24
7323 2423 11	355-315	32,2	28,6	177	173	425	11,9	1	24
7323 2523 11	400-315	36,3	28,6	190	165	460	14,8	1	12
7323 2524 11	400-355	36,3	32,2	190	185	463	16,2	1	12
7323 2623 11	450-315	40,9	28,6				18,9	1	-
7323 2624 11	450-355	40,9	32,2				20,5	1	10
7323 2625 11	450-400	40,9	36,3				22,3	1	8
7323 2724 11	500-355	45,4	32,2				26,2	1	8
7323 2725 11	500-400	45,4	36,3				28,1	1	4
7223 2726 11	500-450	45,4	40,9				29,9	1	4

BR PP-RCT Reduktion **kurz** st **SDR11** grün

BR PP-RCT Reducer **short** butt **SDR11** green

Art Nr	D1-D2	e1	e2	L1	L2	z	KG	VE1	VE2
Art No	[mm]	[mm]		[mm]			PU1	PU2	
7325 2319 21	315-200	28,6	18,2				2,80	1	-
7325 2415 21	355-125	32,2	11,4				6,50	1	-
7325 2417 21	355-160	32,2	14,6				6,50	1	-
7325 2519 21	400-200	36,3	18,2				1	1	-
7325 2521 21	400-250	36,3	22,7				7,00	1	-
7325 2619 21	450-200	40,9	18,2				7,80	1	-
7325 2621 21	450-250	40,9	22,7				7,00	1	-
7325 2719 21	500-200	45,4	18,2				10,0	1	-
7325 2721 21	500-250	45,4	22,7				10,0	1	-
7325 2723 21	500-315	45,4	28,6				18,2	1	-

BR PP-RCT Reduktion lang st **SDR17(-11)** grün

BR PP-RCT Reducer long butt **SDR17(-11)** green

Art Nr	D1-D2	e1	e2*	L1	L2	z	KG	VE1	VE2
Art No	[mm]	[mm]		[mm]			PU1	PU2	
7324 1714 11	160-110	9,5	10,0*	110	93	255	1,15	1	175
7324 1715 11	160-125	9,5	11,4*	113	95	260	1,12	1	175
7324 1917 11	200-160	11,9	9,5	142	117	303	2,61	1	62
7324 2117 11	250-160	14,8	9,5	138	111	339	3,95	1	36
7324 2119 11	250-200	14,8	11,9	140	130	340	4,45	1	36
7324 2321 11	315-250	18,7	14,8	160	145	400	7,85	1	27

* Abgang • Outlet SDR11

BR PP-RCT Reduktion **kurz** st **SDR17(-11)** grün

BR PP-RCT Reducer **short** butt **SDR17(-11)** green

Art Nr	D1-D2	e1	e2*	L1	L2	z	KG	VE1	VE2
Art No	[mm]	[mm]		[mm]			PU1	PU2	
7326 1914 21	200-110	11,9	10,0				1,10	1	-

* Abgang • Outlet SDR11

4.03.04 Flanschverbindung • Flange connection

Vorschweißbund (V-Bund) in gerillter Ausführung für den Einsatz von Flachdichtungen.

Weitere Informationen zu Flanschen und Dichtungen finden Sie unter 6. Zubehör.

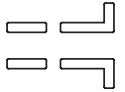

Flange adaptor spigot grooved for the use of flat gaskets.

More information about flanges and gaskets see 6. Accessories.

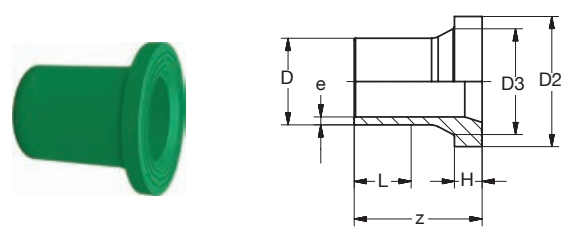
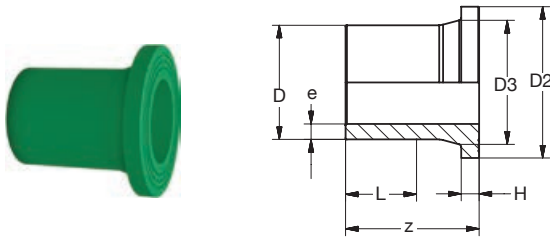

BR PP-RCT V-Bund gerillt lang st **SDR11** grün

BR PP-RCT Flange adaptor spigot grooved long butt **SDR11** green

Art Nr	D	e	D2	D3	H	L	z	KG	VE1	VE2
Art No	[mm]		[mm]						PU1	PU2
7333 17F0 11	160	14,6	212	175	25	110	175	1,57	1	-
7333 19F0 11	200	18,2	268	232	32	127	205	3,90	1	56
7333 21F0 11	250	22,7	320	285	35	146	235	5,02	1	36
7333 23F0 11	315	28,6	370	335	36	185	257	7,40	1	24
7333 24F0 11	355	32,2	430	373	40	182	275	10,6	1	18
7333 25F0 11	400	36,3	482	427	45	192	315	15,2	1	12
7333 26F0 11	450	40,9	585	514	60	220	340	24,4	1	6
7333 27F0 11	500	45,4	585	530	60	234	344	36,0	1	6

BR PP-RCT V-Bund Klappe gerillt lang st **SDR11** grün

BR PP-RCT Flange adaptor valve spigot grooved long butt **SDR11** green

Art Nr	D	e	D2	D3	H	L	z	KG	VE1
Art No	[mm]		[mm]						PU1
7333 15FK 11	125*	12,3	188	155	40	104	185	1,35	1
7333 17FK 11	160	14,6	212	175	25	110	175	1,56	1
7333 19FK 11	200	18,2	268	232	32	127	205	3,02	1
7333 21FK 11	250	22,7	320	285	35	146	235	4,96	1
7333 23FK 11	315	28,6	370	335	36	185	257	7,64	1
7333 24FK 11	355	32,2	430	373	40	182	275	10,57	1

* Klappe und Zubehör = D140
Valve and Accessories = D140

BR PP-RCT V-Bund gerillt lang st **SDR17** grün

BR PP-RCT Flange adaptor spigot grooved long butt **SDR17** green

Art Nr	D	e	D2	D3	H	L	z	KG	VE1	VE2
Art No	[mm]		[mm]						PU1	PU2
7334 17F0 11	160	9,5	212	175	25	110	175	1,49	1	-
7334 19F0 11	200	11,9	268	232	32	127	205	2,90	1	56
7334 21F0 11	250	14,8	320	285	35	146	235	4,74	1	36
7334 23F0 11	315	18,7	370	335	36	185	257	7,40	1	24

BR PP-RCT V-Bund Klappe gerillt lang st **SDR6** grün

BR PP-RCT Flange adaptor valve spigot grooved long butt **SDR6** green

Art Nr	D	e	D2	D3	H	L	z	KG	VE1
Art No	[mm]		[mm]						PU1
7337 14FK 11	110	18,3	158	125	32,0	100	170	1,00	1
7337 15FK 11	125*	20,8	188	155	40	104	185	1,35	1

* Klappe und Zubehör = D140
Valve and Accessories = D140

4.03.04 Flanschverbindung • Flange connection



Zubehör Flanschverbindung V-Bund PP-RCT Accessories Flange Connection spigot PP-RCT



Losflansch
Flange loose

D [mm]	DN [mm]	PP-St			PP-GGG	PP-St
		DIN/EN			ANSI	
		PN10/16	PN10	PN16	150 lbs	
110	100	9143 14E1 15			9153 14A2 25	9143 14A2 38
140	125	9143 16E1 15				
160	150	9143 17E1 15			9153 17A2 25	9143 17A2 38
200	200		9143 19E2 15	9143 19E3 35	9153 19A2 25	9143 19A2 38
250	250		9143 21E2 15	9143 21E3 35	9153 21A2 25	9143 21A2 38
315	300		9143 23E2 15	9143 23E3 35	9153 23A2 25	9143 23A2 38
355	350		9143 24E2 15	9143 24E3 35		
400	400		9143 25E2 15	9143 25E3 35		9143 24A2 38
450	450		9143 26E2 35			
500	500		9143 27E2 35			9143 27A2 38



Blindflansch
Flange blind

D [mm]	DN [mm]	PP-St		
		DIN/EN		ANSI
		PN10/16	PN10	150 lbs
110	100	9144 14E1 35		9144 14A2 38
140	125	9144 16E1 35		
160	150	9144 17E1 35		9144 17A2 38
200	200		9144 19E2 35	9144 19A2 38
250	250		9144 21E2 35	9144 21A2 38
315	300		9144 23E2 35	9144 23A2 38
355	350		9144 24E2 35	
400	400		9144 25E2 35	



Flachdichtring mit Stahl-Einlage
Flat gasket with steel-inlay

D [mm]	DN [mm]	EPDM-St	NBR-St
		Wasser/Water	Gas/Gas
		SDR11	SDR11
110	100	9203 14F1 35	9203 14F2 35
140	125	9203 16F1 35	9203 16F2 35
160	150	9203 17F1 35	9203 17F2 35
180	150	9203 18F1 35	9203 18F2 35
200	200	9203 19F1 35	9203 19F2 35
225	200	9203 20F1 35	9203 20F2 35
250	250	9203 21F1 35	9203 21F2 35
280	250	9203 22F1 35	9203 22F2 35
315	300	9203 23F1 35	9203 23F2 35
355	350	9203 24F1 35	9203 24F2 35
400	400	9203 25F1 35	9203 25F2 35
450	450	9203 26F1 35	9203 26F2 35
500	500	9203 27F1 35	9203 27F2 35

4.04 Formteile Heizwendel-Muffen-Schweißen Fittings electrofusion-socketwelding

PP-RCT E-Muffe

Beschreibung

PP-RCT Heizwendel Schweißmuffe, gespritzt, SDR7,4 – 17, monofilar, d20 – 500

Werkstoff

PP-RCT (Polypropylen Random-Copolymer Temperature-resistant) mit modifizierter Kristallstruktur (beta nukleiert) und erhöhter Temperaturbeständigkeit, Borealis RA7050GN, Farbe RAL 6024 Verkehrsgrün.

Das Material entspricht den Anforderungen der aktuellen KTW-Leitlinie des Umweltbundesamtes (UBA).

Geometrische Eigenschaften

Innendurchmesser und Wanddicke entsprechend DIN EN ISO 15874.

Toleranzen bei den Z-Maßangaben sind abhängig von der Dimension. Bis d/D 160 = +/- 3 mm. Ab d/D 180 = +/- 10 mm.

Betriebsdruck

Entsprechend der SDR-Klasse des Rohres / der Muffe. Anwendungsklasse nach DIN EN ISO 15874: siehe nachfolgende Tabelle.

Ausführung

Geeignet für Heizwendel-Muffen-Schweißung nach DVS Richtlinie 2207. Schweiß-Geräte und Schweiß-Werkzeuge sollten der DVS Richtlinie 2208 entsprechen. Zur Verwendung als Schiebemuffe kann der mittige Anschlag entfernt werden.

PP-RCT E-Socket

Description

PP-RCT Electrofusion socket, injection moulded, SDR7,4 – 17, monofilar, d20 - 500

Material

PP-RCT (Polypropylene Random-Copolymer Temperature-resistant) with modified crystalline structure (beta nucleated) and increased temperature resistance, Borealis RA7050GN, colour RAL 6024 traffic green.

The material complies with the requirements of the KTW guideline of the German Federal Environmental Agency (UBA).

Geometric Properties

Inside diameter and wall thickness according to DIN EN ISO 15874.

Tolerances of z-sizes depends on the dimension. Up to d/D 160 = +/- 3 mm and from d/D 180 = +/- 10 mm.

Working pressure

According to the SDR-class of the pipe / socket. Application class according to DIN EN ISO 15874: see following table.

Type

Suitable for electrofusion-socket-welding according to DVS technical code 2207. Welding equipment according to DVS technical code 2208. For use as a sliding socket, the central stop can be removed.

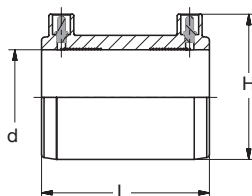

PP-RCT E-Muffe grün
PP-RCT E-Socket green

Art Nr	d [mm]	L [mm]	H [mm]	SDR	kg	VE1	VE2
Art No	[mm]	[mm]				PU1	PU2
7HM2 0600 21	20	70	52	7,4	0,04	1	-
7HM2 0700 21	25	70	57	7,4	0,05	1	-
7HM2 0800 21	32	80	65	7,4	0,07	1	-
7HM2 0900 21	40	90	74	7,4	0,10	1	-
7HM2 1000 21	50	100	85	7,4	0,16	1	-
7HM2 1100 21	63	111	97	7,4	0,26	1	-
7HM2 1200 21	75	120	114	7,4	0,41	1	-
7HM2 1300 21	90	130	130	7,4	0,51	1	-
7HM2 1400 21	110	140	152	7,4	0,80	1	-
7HM2 1500 21	125	151	168	7,4	0,95	1	-
7HM2 1700 21	160	172	205	7,4	1,30	1	-
7HM2 1900 21	200	203	245	7,4	1,90	1	-
7HM2 2100 21	250	244	315	7,4	4,50	1	-
7HM4 2300 21	315	284	375	11	10,8	1	-
7HM4 2400 21	355	312	435	11	11,8	1	-
7HM6 2500 21	400	340	482	17	14,5	1	-
7HM5 2600 21	450	350	534	13,6	18,7	1	-
7HM5 2700 21	500	359	593	13,6		1	-

Druck • Pressure

Schweißparameter • Welding parameter

15874-2: Class 1 [MPa]	R (23°C) [Ohm]	RMS [Volt]	Schweißzeit • Welding time [sec]	Abkühlzeit • Cooling time [min]
1	0,76	11	65	10
1	0,76	13	55	10
1	1,25	20	55	10
1	1,90	24	105	10
1	1,41	24	150	15
1	0,85	24	145	15
1	0,79	24	165	20
1	0,76	24	210	20
1	0,57	24	250	20
1	1,16	40	180	20
1	0,84	40	270	30
0,8 *	0,70	40	270	30
0,8 *	0,54	40	480	30
0,8 *	0,51	40	600	30
0,8 *	0,50	40	600	30
0,8 *	0,55	42	800	30
0,8 *	0,67	44	800	40

* in Anlehnung an • according to DIN EN ISO 15874-2

5 PP-INDUSTRIAL

Kunststoffrohre und Formteile der Linie PP-INDUSTRIAL weisen generell alle Vorteile auf, die sich seit Jahrzehnten in allen Bereichen der industriellen Anwendung bewährt haben. Vor allem die ausgezeichnete Korrosionsbeständigkeit bietet die Gewähr für eine langlebige und beständige Gebrauchsdauer. Charakteristisch sind die hohe chemische Beständigkeit und die guten Langzeiteigenschaften gegenüber vielen Medien. aus

Eigenschaften

- Hohe chemische Beständigkeit
- Hohe Korrosionsbeständigkeit
- Hervorragende Verarbeitbarkeit

Werkstoff

PP (Polypropylen) mit hohem Molekulargewicht und hoch wärmestabilisiert, RAL 7032 Kieselgrau.

Verbindungstechnik

- Heizelement-Stumpf-Schweißung
- Heizelement-Muffen-Schweißung
- Heizwendel-Muffen-Schweißung
- Flanschverbindung

Plastic pipes and fittings in the line PP-INDUSTRIAL generally have all of the advantages, which have been approved and tested for decades in all areas of industrial applications. Particularly the outstanding resistance of corrosion guarantees a long-lasting and durable service life. Advantages are a high resistance to chemicals and good long-term properties compared to many other media are characteristic.

Properties

- High chemical resistance
- High corrosion resistance
- Excellent processing capability

Material

PP (Polypropylene) with a high molecular weight and high heat stabilisation, RAL 7032 pebble grey.

Joining technology

- Butt-welding
- Socket-welding
- Electrofusion socket-welding
- Flange connection



5.01 Rohre • Pipes **IND 3**

5.01.01 Rohre einlagig
Pipes single-layer **IND 3**



5.01.02 Rohre mehrlagig
Pipes multi-layer **IND 5**



5.02 Formteile Muffen-Schweißen
Fittings socket-welding **IND 6**

5.02.01 Winkel
Elbows **IND 6**

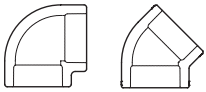

5.03 Formteile Stumpf-Schweißen
Fittings butt-welding **IND 12**

5.03.01 Bögen, Winkel
Bends, Elbows **IND 12**

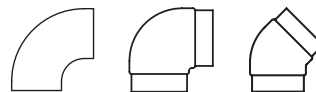

5.02.02 T-Stücke, Abzweige
Tee's, Branches **IND 7**

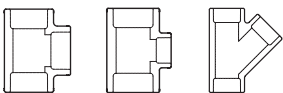

5.03.02 T-Stücke
Tee's **IND 13**

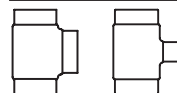

5.02.03 Reduktionen, Muffen, Kappen
Reducers, Sockets, Caps **IND 8**

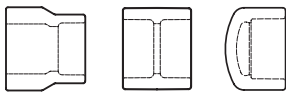

5.03.03 Reduktionen
Reducers **IND 14**



5.02.04 Verschraubungen
Unions **IND 9**



5.03.04 Übergänge
Transitions **IND 15**

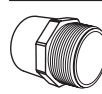

5.02.05 Flanschverbindung
Flange connection **IND 10**

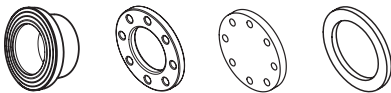

5.03.05 Verschraubungen
Unions **IND 16**

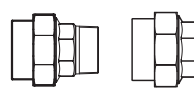

5.02.06 Kugelhähne
Ball Valves **IND 11**

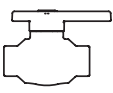

5.03.06 Flanschverbindung
Flange connection **IND 18**

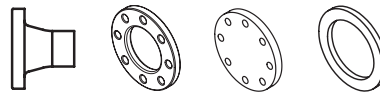

5.04 Armaturen • Valves **IND 20**

5.01.01 Rohre einlagig • Pipes single-layer

PP-INDUSTRIALTEC Druckrohr SDR11 grau 5m

Beschreibung

PP-R Druckrohr, SDR11.

Werkstoff

PP-R (Polypropylen - Random-copolymer), Borealis RA130E, mit hohem Molekulargewicht und hoch wärmostabilisiert, RAL 7032 Kieselgrau.
Das Material entspricht den Anforderungen der aktuellen KTW-Leitlinie des Umweltbundesamtes (UBA).

Geometrische Eigenschaften und Nennrücke

Abmessungen und Toleranzen entsprechend DIN 8077 und DIN EN ISO 15494 Anhang E.

Zertifizierung

B-R Rohre unterliegen regelmäßigen internen Qualitätskontrollen.

Lieferung

In 5 m Stangen und abgepackt in Bündeln, bzw. ab D125 einzeln verpackt. Alle Rohre/Bünde sind in schwarzer UV-Schutz-Schlauchfolie verpackt. Abgabe erfolgt nur in kompletten Verpackungseinheiten (VE's).
Nachfolgetyp: PP-INDUSTRIALTEC-CT.

PP-INDUSTRIALTEC Pressure Pipe SDR11 grey 5m

Description

PP-R Pressure Pipe, SDR11

Material

PP-R (Polypropylene - Random-copolymer), Borealis RA130E, with a high molecular weight and high heat stabilisation, RAL 7032 pebble grey.
The material complies with the requirements of the KTW-guideline of the German Federal Environmental Agency (UBA).

Geometric Properties and Nominal Pressure

Dimensions and tolerances according to DIN 8077 and DIN EN ISO 15494 appendix E.

Certification

B-R pipes succumb frequent internal quality controls.

Delivery

In 5 m rods and packed in bundles or from D125 and above individually packed. All pipes/bundles are packed in black UV-protection-foil. Supply only in complete packing units (PU's).
Follow-up type: PP-INDUSTRIALTEC-CT.

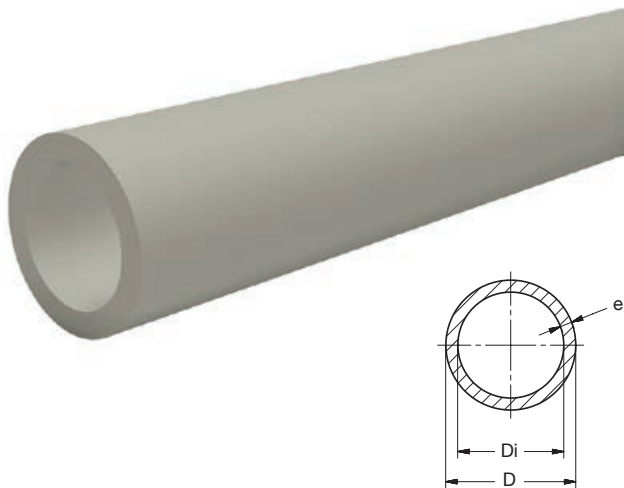

BR PP-INDUSTRIALTEC Druckrohr SDR11 grau 5m

BR PP-INDUSTRIALTEC Pressure Pipe SDR11 grey 5m

Art Nr	D	e	DN	di	SDR	L	KG	VE1	VE2
Art No	[mm]		[mm]			[m]		PU1	PU2
5114 0650 18	20	1,9	15	16,2	11	5	0,11	125	4375
5114 0750 18	25	2,3	20	20,4	11	5	0,16	125	2875
5114 0850 18	32	2,9	25	26,2	11	5	0,26	75	1500
5114 0950 18	40	3,7	32	32,6	11	5	0,41	50	1050
5114 1050 18	50	4,6	40	40,8	11	5	0,64	25	750
5114 1150 18	63	5,8	50	51,4	11	5	1,01	25	500
5114 1350 18	90	8,2	65	73,6	11	5	2,03	10	220
5114 1550 18	125	11,4	100	102,2	11	5	3,91	5	125
5114 1750 18	160	14,6	125	130,8	11	5	6,38	5	60



PP-INDUSTRIALTEC-CT Druckrohr SDR11 grau 5m

Beschreibung

PP-RCT Druckrohr, SDR11, mit einer bis zu 60% höheren Druckbelastbarkeit gegenüber Druckrohr aus PP-R.

Werkstoff

PP-RCT (Polypropylene - Random-copolymer, Crystalline-structure, Temperature-resistant), Borealis RA7050LG, mit hohem Molekulargewicht und hoch wärmostabilisiert, RAL 7032 Kieselgrau.

Das Material entspricht den Anforderungen der aktuellen KTW-Leitlinie des Umweltbundesamtes (UBA).

Geometrische Eigenschaften und Nenndrücke

Abmessungen und Toleranzen entsprechend DIN 8077 und DIN EN ISO 15494 Anhang E.

Zertifizierung

B-R Rohre unterliegen regelmäßigen internen und externen Qualitätskontrollen.

Lieferung

In 5 m Stangen und abgepackt in Bündeln, bzw. ab D125 einzeln verpackt. Alle Rohre/Bünde sind in schwarzer UV-Schutz-Schlauchfolie verpackt. Abgabe erfolgt nur in kompletten Verpackungseinheiten (VE's).

PP-INDUSTRIALTEC-CT Pressure Pipe SDR11 grey 5m

Description

PP-RCT Pressure Pipe, SDR11, with a 60% higher pressure rate compared to PP-R pressure pipes.

Material

PP-RCT (Polypropylene - Random-copolymer, Crystalline-structure, Temperature-resistant), Borealis RA7050LG, with a high molecular weight and high heat stabilisation, RAL 7032 pebble grey.

The material complies with the requirements of the KTW-guideline of the German Federal Environmental Agency (UBA).

Geometric Properties and Nominal Pressure

Dimensions and tolerances according to DIN 8077 and DIN EN ISO 15494 appendix E.

Certification

B-R pipes succumb frequent internal and external quality controls.

Delivery

In 5 m rods and packed in bundles or from D125 and above individually packed. All pipes/bundles are packed in black UV-protection-foil. Supply only in complete packing units (PU's).

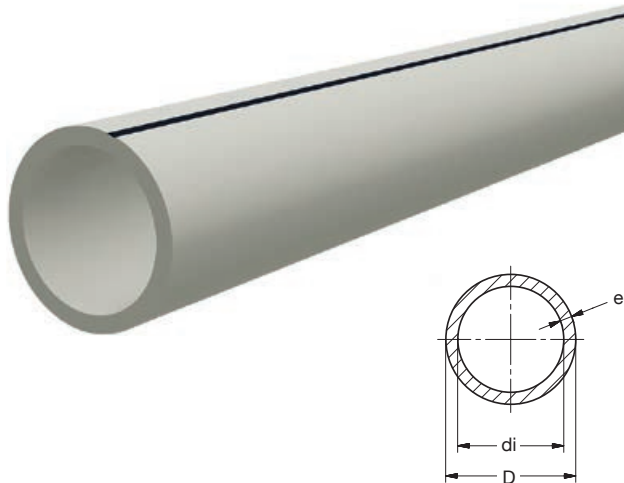

BR PP-INDUSTRIALTEC-CT Druckrohr SDR11 grau 5m

BR PP-INDUSTRIALTEC-CT Pressure Pipe SDR11 grey 5m

Art Nr	D	e	DN	di	SDR	L	KG	VE1	VE2
Art No	[mm]		[mm]	[mm]		[m]		PU1	PU2
7114 0650 18	20	1,9	15	16,2	11	5	0,11	125	4375
7114 0750 18	25	2,3	20	20,4	11	5	0,16	125	2875
7114 0850 18	32	2,9	25	26,2	11	5	0,26	75	1500
7114 0950 18	40	3,7	32	32,6	11	5	0,41	50	1050
7114 1050 18	50	4,6	40	40,8	11	5	0,64	25	750
7114 1150 18	63	5,8	50	51,4	11	5	1,01	25	500
7114 1250 18	75	6,8	-	61,4	11	5	1,41	10	320
7114 1350 18	90	8,2	65	73,6	11	5	2,03	10	220
7114 1450 18	110	10,0	80	90,0	11	5	3,01	10	150
7114 1550 18	125	11,4	100	102,2	11	5	3,91	5	125
7114 1650 18	140	12,7	-	114,6	11	5	4,87	5	-
7114 1750 18	160	14,6	125	130,8	11	5	6,38	5	60
7114 1850 18	180	16,4	-	147,2	11	5	8,07	5	-
7114 1950 18	200	18,2	160	163,6	11	5	9,95	5	45
7114 2050 18	225	20,5	-	184,0	11	5	12,6	5	-
7114 2150 18	250	22,7	200	204,6	11	5	15,5	5	25
7114 2250 18	280	25,4	-	229,2	11	5	19,4	5	-
7114 2350 18	315	28,6	250	257,8	11	5	24,6	5	10

PP-INDUSTRIALTEC-CTplus Druckrohr SDR11 grau 5m

Beschreibung

PP-RCT Druckrohr, SDR11, mit einer bis zu 60% höheren Druckbelastbarkeit gegenüber Druckrohr aus PP-R, plus einer Faser-Mittelschicht zur Reduzierung der axialen Längenausdehnung um bis zu Faktor 4 gegenüber einlagigen Rohren.

Werkstoff

PP-RCT (Polypropylene - Random-copolymer, Crystalline-structure, Temperature-resistant), Borealis RA7050LG, mit hohem Molekulargewicht und hoch wärmostabilisiert, RAL 7032 Kieselgrau.

Das Material entspricht den Anforderungen der aktuellen KTW-Leitlinie des Umweltbundesamtes (UBA).

Geometrische Eigenschaften

Abmessungen und Toleranzen entsprechend DIN 8077 und DIN EN ISO 15494 Anhang E.

Zertifizierung

B-R Rohre unterliegen regelmäßigen internen und externen Qualitätskontrollen.

Lieferung

In 5 m Stangen und abgepackt in Bündeln, bzw. ab D125 einzelpackiert. Alle Rohre/Bünde sind in schwarzer UV-Schutz-Schlauchfolie verpackt. Abgabe erfolgt nur in kompletten Verpackungseinheiten (VE's).

PP-INDUSTRIALTEC-CTplus Pressure Pipe SDR11 grey 5m

Description

PP-RCT Pressure Pipe, SDR11, with a 60% higher pressure rate compared to PP-R pressure pipes, plus a fiber-middle-layer for reducing the axial elongation by up to a factor of 4 compared to single-layered pipes.

Material

PP-RCT (Polypropylene - Random-copolymer, Crystalline-structure, Temperature-resistant), Borealis RA7050LG, with a high molecular weight and high heat stabilisation, RAL 7032 pebble grey.

The material complies with the requirements of the KTW guideline of the German Federal Environmental Agency (UBA).

Geometric Properties

Dimensions and tolerances according to DIN 8077 and DIN EN ISO 15494 appendix E.

Certification

B-R pipes succumb frequent internal and external quality controls.

Delivery

In 5 m rods and packed in bundles or from D125 and above individually packed. All pipes/bundles are packed in black UV-protection-foil. Supply only in complete packing units (PU's).

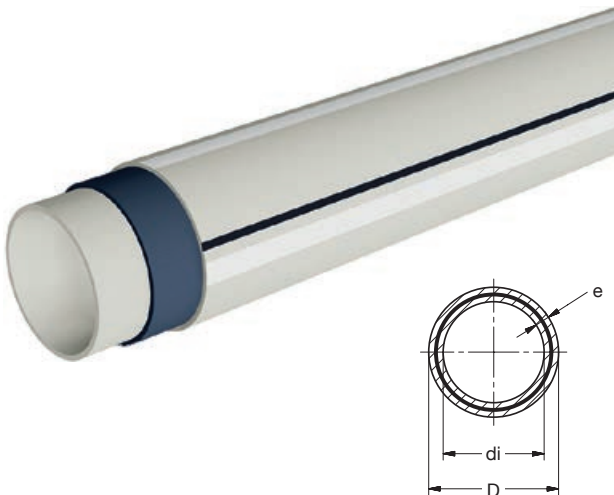

BR PP-INDUSTRIALTEC-CTplus Druckrohr SDR11 grau 5m

BR PP-INDUSTRIALTEC-CTplus Pressure Pipe SDR11 grey 5m

Art Nr	D	e	DN	di	SDR	L	KG	VE1	VE2
Art No	[mm]		[mm]	[mm]		[m]		PU1	PU2
7F12 0650 18	20	2,8	-	14,4	7,4	5	0,15	125	4375
7F12 0750 18	25	3,5	15	18,0	7,4	5	0,23	125	2875
7F13 0850 18	32	3,6	25	24,8	9	5	0,31	75	1500
7F14 0950 18	40	3,7	32	32,6	11	5	0,41	50	1050
7F14 1050 18	50	4,6	40	40,8	11	5	0,64	25	750
7F14 1150 18	63	5,8	50	51,4	11	5	1,01	25	500
7F14 1250 18	75	6,8	-	61,4	11	5	1,41	10	320
7F14 1350 18	90	8,2	65	73,6	11	5	2,03	10	220
7F14 1450 18	110	10,0	80	90,0	11	5	3,01	10	150
7F14 1550 18	125	11,4	100	102,2	11	5	3,91	5	125
7F14 1650 18	140	12,7	-	114,6	11	5	4,87	5	-
7F14 1750 18	160	14,6	125	130,8	11	5	6,38	5	60
7F14 1850 18	180	16,4	-	147,2	11	5	8,07	5	-
7F14 1950 18	200	18,2	160	163,6	11	5	9,95	5	45
7F14 2050 18	225	20,5	-	184,0	11	5	12,6	5	-
7F14 2150 18	250	22,7	200	204,6	11	5	15,5	5	25
7F14 2250 18	280	25,4	-	229,2	11	5	19,4	5	-
7F14 2350 18	315	28,6	250	257,8	11	5	24,6	5	10

PP-INDUSTRIAL Formteile mit Schweißmuffen grau gespritzt, für die Heizelement-Muffen-Schweißung

Werkstoff

Polypropylen, RAL 7032 Kieselgrau.

Geometrische Eigenschaften

Abmessungen und Toleranzen entsprechend DIN EN ISO 15494 Anhang E; Muffe Typ A.

Toleranzen bei den Z-Maßangaben sind abhängig von der Dimension. Bis d/D 160 = +/- 3 mm. Ab d/D 180 = +/- 10 mm.

Ausführung

Geeignet für Heizelement-Muffen-Schweißung nach DVS Richtlinie 2207. Schweiß-Geräte und Schweiß-Werkzeuge sollten der DVS Richtlinie 2208 entsprechen.

PP-INDUSTRIAL Fittings with welding sockets grey injection moulded, for socket-welding

Material

Polypropylene, RAL 7032 pebble grey.

Geometric Properties

Dimensions and tolerances according to DIN EN ISO 15494 appendix E; socket type A.

Tolerances of z-sizes depends on the dimension. Up to d/D 160 = +/- 3 mm and from d/D 180 = +/- 10 mm.

Type

Suitable for socket-welding according to DVS technical code 2207. Welding equipment according to DVS technical code 2208.

5.02.01 Winkel • Elbows

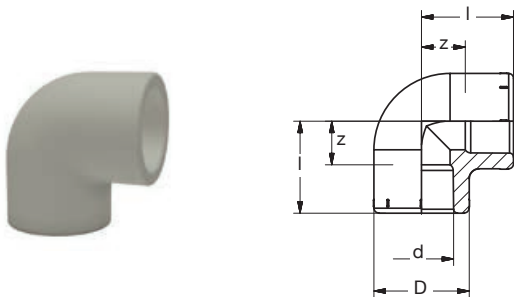

BR PP-INDUSTRIAL Winkel 90° grau

BR PP-INDUSTRIAL Elbow 90° grey

Art Nr	d	D	l	z	KG	VE1	VE2
Art No	[mm]		[mm]			PU1	PU2
5411 0690 18	20	29	28	13	0,019	10	120
5411 0790 18	25	34	32	16	0,025	10	80
5411 0890 18	32	43	38	20	0,047	10	80
5411 0990 18	40	52	44	23	0,073	5	50
5411 1090 18	50	65	52	28	0,14	10	60
5411 1190 18	63	84	62	34	0,27	4	32
5411 1290 18	75	101	71	41	0,44	2	18
5411 1390 18	90	120	83	50	0,79	2	12
5411 1490 18	110	148	99	62	1,30	1	3

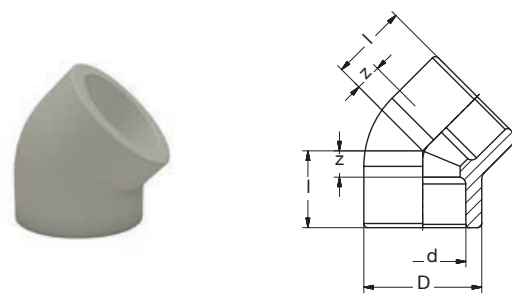

BR PP-INDUSTRIAL Winkel 45° grau

BR PP-INDUSTRIAL Elbow 45° grey

Art Nr	d	D	l	z	KG	VE1	VE2
Art No	[mm]		[mm]			PU1	PU2
5411 0645 18	20	29	21	6	0,014	10	150
5411 0745 18	25	34	24	8	0,019	10	90
5411 0845 18	32	43	28	10	0,034	10	50
5411 0945 18	40	52	32	11	0,056	5	30
5411 1045 18	50	65	37	13	0,10	5	45
5411 1145 18	63	82	44	16	0,21	2	40
5411 1245 18	75	99	50	20	0,32	2	24
5411 1345 18	90	120	58	25	0,58	2	10
5411 1445 18	110	148	69	32	0,98	2	4

5.02.02 T-Stücke, Abzweige • Tee's, Branches

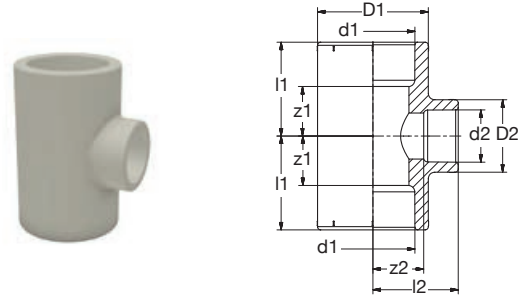
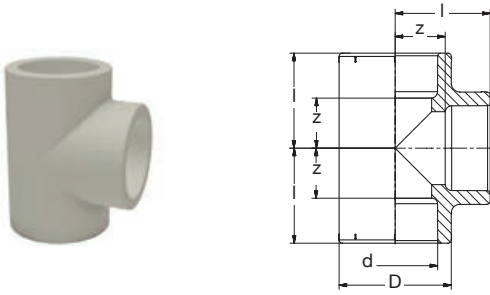

BR PP-INDUSTRIAL T-Stück 90° grau
BR PP-INDUSTRIAL Tee 90° grey

BR PP-INDUSTRIAL T-Stück 90° red grau
BR PP-INDUSTRIAL Tee 90° red grey

Art Nr	d	D	l	z	KG	VE1	VE2
Art No	[mm]	[mm]	[mm]	[mm]		PU1	PU2
5511 0690 18	20	29	28	13	0,023	10	80
5511 0790 18	25	34	32	16	0,034	10	50
5511 0890 18	32	43	38	20	0,060	5	70
5511 0990 18	40	52	44	23	0,090	5	40
5511 1090 18	50	65	52	28	0,17	10	50
5511 1190 18	63	84	62	34	0,34	2	8
5511 1290 18	75	100	71	41	0,54	2	16
5511 1390 18	90	120	83	50	0,95	2	12
5511 1490 18	110	148	99	62	1,56	1	2

Art Nr	d1 - d2	D1	D2	l1	l2	z1	z2	KG	VE1	VE2
Art No	[mm]	[mm]	[mm]	[mm]	[mm]	[mm]	[mm]		PU1	PU2
5521 0706 18	25-20	34	29	32	32	16	17	0,035	10	60
5521 0806 18	32-20	43	29	38	36	20	21	0,060	5	30
5521 0807 18	32-25	43	34	38	36	20	22	0,060	5	30
5521 0906 18	40-20	52	43	44	39	24	24	0,083	5	40
5521 0907 18	40-25	52	43	44	40	23	24	0,086	5	40
5521 0908 18	40-32	52	43	44	40	23	22	0,091	5	40
5521 1007 18	50-25	65	43	52	46	28	30	0,16	10	50
5521 1008 18	50-32	65	43	52	46	28	28	0,16	10	50
5521 1009 18	50-40	85	85	62	62	39	35	0,16	10	50
5521 1107 18	63-25	85	43	62	62	35	46	0,31	2	8
5521 1108 18	63-32	85	43	62	62	35	44	0,31	2	8
5521 1109 18	63-40	85	85	62	62	35	42	0,32	2	8
5521 1110 18	63-50	85	85	62	62	35	39	0,32	2	8
5521 1208 18	75-32	100	43	71	71	41	53	0,50	2	16
5521 1209 18	75-40	100	65	71	71	41	51	0,50	2	16
5521 1210 18	75-50	100	65	71	71	41	48	0,51	2	16
5521 1211 18	75-63	100	101	71	71	41	44	0,52	2	16
5521 1311 18	90-63	85	83	83	50	50	53	0,91	2	12
5521 1312 18	90-75	120	100	83	83	50	53	0,91	2	12
5521 1411 18	110-63	148	85	99	99	62	71	1,53	1	3
5521 1412 18	110-75	148	100	99	99	62	69	1,54	1	3
5521 1413 18	110-90	148	120	99	99	62	66	1,57	1	3

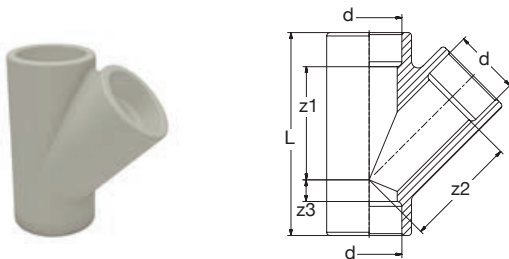

BR PP-INDUSTRIAL Abzweig 45° 20°C/1,0MPa grau
BR PP-INDUSTRIAL Branch 45° 20°C/1.0MPa grey

Art Nr	d	L	z1	z2	z3	KG	VE1	VE2
Art No	[mm]	[mm]	[mm]	[mm]	[mm]		PU1	PU2
5511 0845 18	32	89	40	41	11	0,062	10	50
5511 0945 18	40	122	65	64	16	0,15	1	30
5511 1045 18	50	131	67	67	18	0,23	1	20
5511 1145 18	63	169	91	89	23	0,50	1	20

5.02.03 Reduktionen, Muffen, Kappen • Reducers, Sockets, Caps

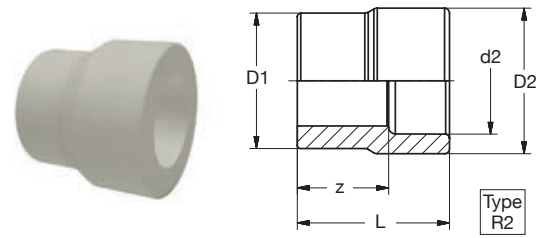
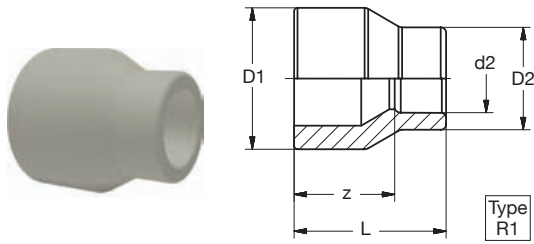

BR PP-INDUSTRIAL Reduktion grau
BR PP-INDUSTRIAL Reducer grey

Art Nr	D1 - d2	Type	D2	L	z	KG	VE1	VE2
Art No	[mm]	R1 R2	[mm]	[mm]	[mm]		PU1	PU2
5321 0706 18	25-20	•	29	36	22	0,012	10	100
5321 0806 18	32-20	•	29	37	23	0,015	10	80
5321 0807 18	32-25	•	34	39	23	0,017	10	70
5321 0906 18	40-20	•	34	43	28	0,023	10	50
5321 0907 18	40-25	•	34	43	27	0,023	10	50
5321 0908 18	40-32	•	43	45	27	0,029	10	80
5321 1006 18	50-20	•	43	51	36	0,043	10	50
5321 1007 18	50-25	•	43	51	35	0,043	10	50
5321 1008 18	50-32	•	43	51	33	0,045	10	50
5321 1009 18	50-40	•	52	53	33	0,055	10	70
5321 1106 18	63-20	•	34	56	42	0,079	5	60
5321 1107 18	63-25	•	34	56	40	0,076	5	60
5321 1108 18	63-32	•	43	58	40	0,076	5	60
5321 1109 18	63-40	•	52	60	40	0,084	5	45
5321 1110 18	63-50	•	65	63	40	0,091	5	40
5321 1210 18	75-50	•	65	67	44	0,12	2	16
5321 1211 18	75-63	•	80	71	44	0,15	2	16
5321 1310 18	90-50	•	65	74	51	0,15	2	12
5321 1311 18	90-63	•	80	78	51	0,17	2	12
5321 1312 18	90-75	•	99	81	51	0,23	2	12
5321 1411 18	110-63	•	85	87	60	0,32	2	14
5321 1412 18	110-75	•	100	90	60	0,37	2	14
5321 1413 18	110-90	•	120	93	61	0,45	2	14

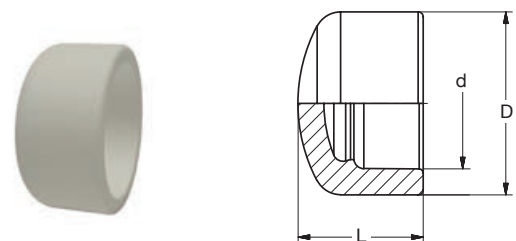
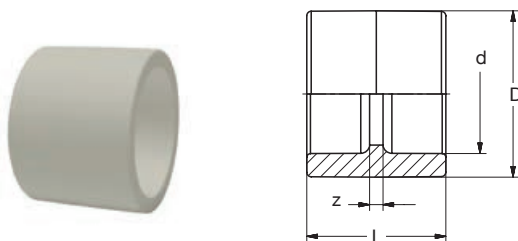

BR PP-INDUSTRIAL Muffe grau
BR PP-INDUSTRIAL Socket grey

Art Nr	d	D	L	z	KG	VE1	VE2
Art No	[mm]	[mm]	[mm]	[mm]		PU1	PU2
5311 0600 18	20	29	34	5	0,010	10	150
5311 0700 18	25	34	37	5	0,015	10	120
5311 0800 18	32	43	41	5	0,026	10	60
5311 0900 18	40	52	46	5	0,047	10	80
5311 1000 18	50	65	52	5	0,070	10	60
5311 1100 18	63	84	60	5	0,13	4	84
5311 1200 18	75	101	65	5	0,20	2	40
5311 1300 18	90	120	76	10	0,35	2	16
5311 1400 18	110	148	80	5	0,57	2	18

BR PP-INDUSTRIAL Kappe grau
BR PP-INDUSTRIAL Cap grey

Art Nr	d	D	l	KG	VE1	VE2
Art No	[mm]	[mm]	[mm]		PU1	PU2
5341 0600 18	20	29	25	0,009	10	200
5341 0700 18	25	34	28	0,013	10	100
5341 0800 18	32	43	32	0,021	10	120
5341 0900 18	40	52	36	0,033	10	60
5341 1000 18	50	65	41	0,057	10	80
5341 1100 18	63	79	48	0,090	5	60
5341 1200 18	75	99	54	0,18	2	20
5341 1300 18	90	120	66	0,35	2	8
5341 1400 18	110	148	79	0,59	1	8

5.02.04 Verschraubungen • Unions

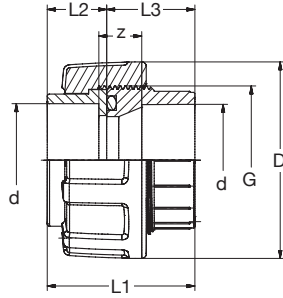

BR PP-INDUSTRIAL Verschraubung Runddichtring-EPDM 20°C/1,0MPa grau

BR PP-INDUSTRIAL Union O-Ring-gasket-EPDMEPDM 20°C/1.0MPa grey

Art Nr	d	D	G	L1	L2	L3	z	KG	VE1	VE2
Art No	[mm]	[mm]	[Inch]	[mm]					PU1	PU2
5351 0600 38	20	46	1	44,0	17,5	26	15	0,039	1	250
5351 0700 38	25	56	1 1/4	47,5	19,0	28	15	0,061	1	125
5351 0800 38	32	66	1 1/2	51,5	21,0	30	15	0,091	1	100
5351 0900 38	40	79	2	58,0	23,5	34	17	0,14	1	60
5351 1000 38	50	87	2 1/4	66,0	26,5	39	19	0,17	1	40
5351 1100 38	63	107	2 3/4	78,5	30,5	47	23	0,28	1	30

Einzelteile

Spare parts

d	Einlegteil
[mm]	Insert-part
20	5351 06E0 18
25	5351 07E0 18
32	5351 08E0 18
40	5351 09E0 18
50	5351 10E0 18
63	5351 11E0 18

d	Schraubteil
[mm]	Screw-part
20	5351 06S0 18
25	5351 07S0 18
32	5351 08S0 18
40	5351 09S0 18
50	5351 10S0 18
63	5351 11S0 18

d	Überwurfmutter
[mm]	Union-nut
20	5351 06U0 38
25	5351 07U0 38
32	5351 08U0 38
40	5351 09U0 38
50	5351 10U0 38
63	5351 11U0 38

d	Runddichtring-EPDM
[mm]	O-Ring-gasket-EPDM
20	9205 46R1 35
25	9201 07R1 35
32	9205 48R1 35
40	9205 50R1 35
50	9205 51R1 35
63	9205 54R1 35

5.02.05 Flanschverbindung • Flange connection

Bundbuchse (B-Buchse) in gerillter Ausführung für den Einsatz von Flachdichtungen.

Weitere Informationen zu Flanschen und Dichtungen finden Sie unter Zubehör.

Flange adaptor socket in grooved design for the use of flat-gaskets.

More information about flanges and gaskets see Accessories.

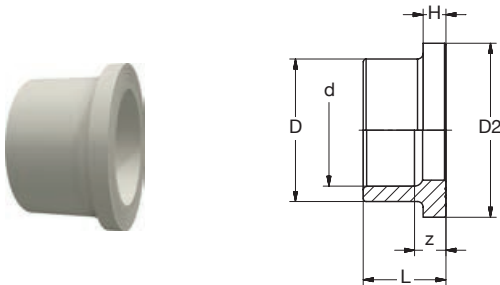

BR PP-INDUSTRIAL Bundbuchse gerillt grau

BR PP-INDUSTRIAL Flange adaptor socket grooved grey

Art Nr	d	D	D2	L	H	z	KG	VE1	VE2
Art No	[mm]	[mm]						PU1	PU2
5331 09F0 18	40	50	61	29	8	9	0,027	10	100
5331 10F0 18	50	61	74	27	8	4	0,043	10	70
5331 11F0 18	63	76	102	40	17	13	0,11	1	24
5331 12F0 18	75	90	122	38	19	8	0,16	1	16
5331 13F0 18	90	108	137	45	21	12	0,25	1	10
5331 14F0 18	110	131	158	50	21	13	0,30	1	15



Zubehör Flanschverbindung B-Buchse PP-INDUSTRIAL Accessories Flange connection socket PP-INDUSTRIAL



Losflansch
Flange loose



Blindflansch
Flange blind



Flachdichtring mit Stahl-Einlage
Flat-gasket with steel-inlay

d [mm]	DN [mm]	PP-St		PP-GGG	PP-St
		DIN/EN PN10/16	ANSI 150 lbs		
40	32	9141 09E1 15	9141 09A2 38		
50	40	9141 10E1 15	9141 10A2 38		
63	50	9141 11E1 15	9151 11A2 25	9141 12A2 38	
75	65	9141 12E1 15	9141 13A2 38		
90	80	9142 13E1 15	9141 13A2 38		
110	100	9142 14E1 15	9152 14A2 25		

PP-St	
DIN/EN	ANSI
PN10/16	150 lbs
9144 09E1 35	9144 09A2 38
9144 10E1 35	9144 10A2 38
9144 11E1 35	9144 11A2 38
9144 12E1 35	9144 12A2 38
9144 13E1 35	9144 13A2 38
9144 14E1 35	9144 14A2 38

EPDM-St	NBR-St
Wasser/Water	Gas/Gas
PN10	
9202 09F1 35	9202 09F2 35
9202 10F1 35	9202 10F2 35
9202 11F1 35	9202 11F2 35
9202 12F1 35	9202 12F2 35
9202 13F1 35	9202 13F2 35
9202 14F1 35	9202 14F2 35



5.02.06 Kugelhähne • Ball Valves

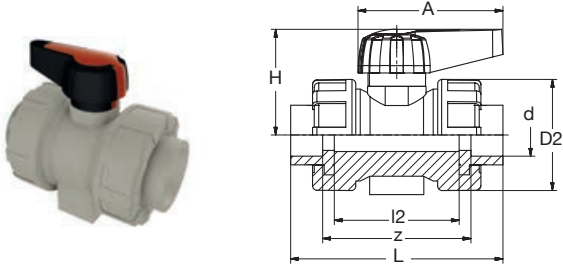

BR PP-INDUSTRIAL Kugelhahn verschraubt 20°C/1,0MPa grau

BR PP-INDUSTRIAL Ball valve with union-nuts 20°C/1.0MPa grey

Art Nr	d	D2	L	l2	H	A	z	KG	VE1	VE2
Art No	[mm]	[mm]							PU1	PU2
591V 06R1 38	20	50,5	96	56,5	48	66,5	67	0,12	1	-
591V 07R1 38	25	59	109	65	57	81,5	77	0,19	1	-
591V 08R1 38	32	70,5	119	71	65	81,5	83	0,28	1	-
591V 09R1 38	40	86	141	85,5	83,5	91,5	100	0,44	1	-
591V 10R1 38	50	99,5	153	89	89,5	91,5	106	0,54	1	-
591V 11R1 38	63	126	172	101	115	143	117	0,93	1	-

mit Runddichtring-EPDM und PTFE-Kugelabdichtung.
with O-Ring-gasket-EPDM and PTFE-Ball-valve-sealing.

5.03 Formteile Stumpf-Schweißen • Fittings butt-welding

PP-INDUSTRIAL Formteile mit Schweißenden SDR11 grau

gespritzt, für die Heizelement-Stumpf-Schweißung

Werkstoff

Polypropylen, RAL 7032 Kieselgrau.

Geometrische Eigenschaften

Abmessungen und Toleranzen entsprechend DIN EN ISO 15494 Anhang E.

Toleranzen bei den Z-Maßangaben sind abhängig von der Dimension.

Bis d/D 160 = +/- 3 mm. Ab d/D 180 = +/- 10 mm.

Ausführung

Geeignet für Heizelement-Stumpfschweißung nach DVS Richtlinie 2207. Schweiß-Geräte und Schweiß-Werkzeuge sollten der DVS Richtlinie 2208 entsprechen.

PP-INDUSTRIAL Fittings with spigots SDR11 grey

injection moulded, for butt-welding

Material

Polypropylene, RAL 7032 pebble grey.

Geometric Properties

Dimensions and tolerances according to DIN EN ISO 15494 appendix E.

Tolerances of z-sizes depends on the dimension.

Up to d/D 160 = +/- 3 mm and from d/D 180 = +/- 10 mm.

Type

Suitable for butt-welding according to DVS technical code 2207. Welding equipment according to DVS technical code 2208.

5.03.01 Bögen, Winkel • Bends, Elbows

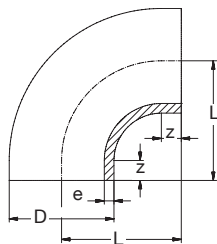

BR PP-INDUSTRIAL Bogen 90° kurz st **SDR11** grau

BR PP-INDUSTRIAL Bend 90° short butt **SDR11** grey

Art Nr	D	e	L	z	KG	VE1	VE2
Art No	[mm]		[mm]			PU1	PU2
5425 0790 28	25	2,3	5	32	0,009	10	140
5425 0890 28	32	3,0	5	40	0,017	10	80
5425 0990 28	40	3,7	7	51	0,036	10	40
5425 1090 28	50	4,6	7	62	0,066	5	40
5425 1190 28	63	5,8	8	77	0,12	5	50
5425 1290 28	75	6,9	10	85	0,21	2	26
5425 1390 28	90	8,2	10	100	0,36	2	16
5425 1490 28	110	10,0	10	120	0,62	2	8
5425 1590 28	125	11,4	15	140	0,95	1	6
5425 1690 28	140	12,7	15	155	1,30	1	4
5425 1790 28	160	14,6	15	175	1,87	1	3
5425 1890 28	180	16,4	15	195	2,77	1	2
5425 1990 28	200	18,2	15	215	3,60	1	-
5425 2090 28	225	20,5	20	245	5,29	1	-
5425 2190 28	250	22,7	25	275	7,21	1	-
5425 2290 28	280	25,4	30	310	10,0	1	-
5425 2390 28	315	28,6	35	350	14,0	1	-

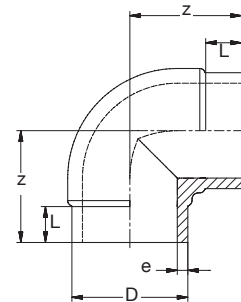

BR PP-INDUSTRIAL Winkel 90° kurz st **SDR11** grau

BR PP-INDUSTRIAL Elbow 90° short butt **SDR11** grey

Art Nr	D	e	L	z	KG	VE1	VE2
Art No	[mm]		[mm]			PU1	PU2
5415 0790 18	25	2,3	12	36	0,014	5	180
5415 0890 18	32	3,0	14	39	0,026	5	130

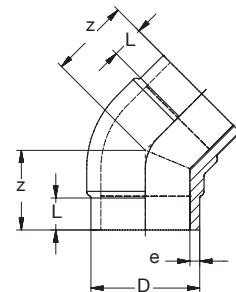

BR PP-INDUSTRIAL Winkel 45° kurz st **SDR11** grau

BR PP-INDUSTRIAL Elbow 45° short butt **SDR11** grey

Art Nr	D	e	L	z	KG	VE1	VE2
Art No	[mm]		[mm]			PU1	PU2
5415 0745 18	25	2,3	12	21	0,01	10	300
5415 0845 18	32	3,0	14	30	0,02	5	300
5415 1345 18	90	8,2	28	66	0,35	1	20
5415 1445 18	110	10,0	34	79	0,54	1	14

5.03.02 T-Stücke • Tee's

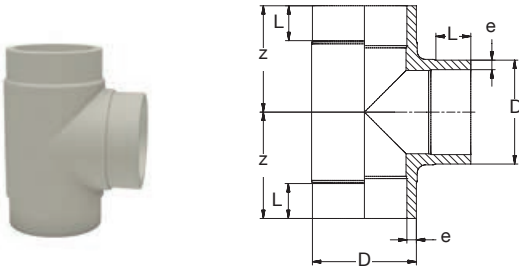

BR PP-INDUSTRIAL T-Stück 90° kurz st **SDR11** grau
BR PP-INDUSTRIAL Tee 90° short butt **SDR11** grey

Art Nr	D	e	L	z	KG	VE1	VE2
Art No	[mm]	[mm]				PU1	PU2
5515 0790 18	25	2,3	12	33	0,025	5	150
5515 0890 18	32	3,0	14	37	0,040	5	80
5515 0990 18	40	3,7	16	42	0,070	1	100
5515 1090 18	50	4,6	18	51	0,14	1	60
5515 1190 18	63	5,8	22	67	0,22	1	50
5515 1290 18	75	6,9	25	75	0,36	1	20
5515 1390 28	90	8,2	23	100	0,65	1	10
5515 1490 28	110	10,0	43	120	1,04	1	6
5515 1590 28	125	11,4	26	125	1,48	1	6
5515 1690 28	140	12,7	32	140	2,06	1	2
5515 1790 28	160	14,6	40	160	2,95	1	2
5515 1890 28	180	16,4	73	195	4,66	1	-
5515 1990 28	200	18,2	64	215	6,47	1	-
5515 2090 28	225	20,5	72	245	9,22	1	-
5515 2190 28	250	22,8	86	275	12,65	1	-
5515 2290 28	280	25,5	105	310	18,20	1	-
5515 2390 28	315	28,6	111	350	27,70	1	-

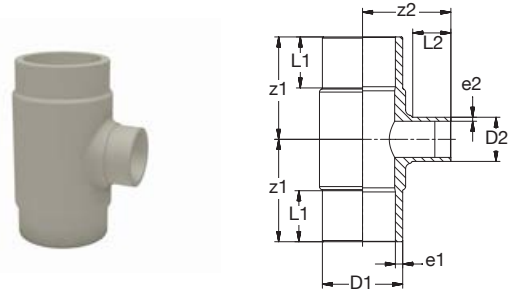

BR PP-INDUSTRIAL T-Stück 90° red kurz st **SDR11** grau
BR PP-INDUSTRIAL Tee 90° red short butt **SDR11** grey

Art Nr	D1-D2	e1	e2	L1	L2	z1	z2	KG	VE1	VE2
Art No	[mm]			[mm]					PU1	PU2
5525 1108 18	63-32	5,8	3,0	22	15	67	69	0,19	1	6
5525 1411 18	110-63	10,0	5,8	48	32	120	105	0,90	1	6
5525 1413 18	110-90	10,0	8,2	48	38	120	115	0,97	1	6
5525 1714 18	160-110	14,6	10,0	56	38	160	145	2,81	1	2
5525 2014 18	225-110	20,5	10,0	89	88	220	264	7,07	1	-
5525 2015 18	225-125	20,5	11,4	79	32	185	205	6,39	1	-
5525 2017 18	225-160	20,5	14,6	89	60	235	200	7,21	1	-



5.03.03 Reduktionen • Reducers

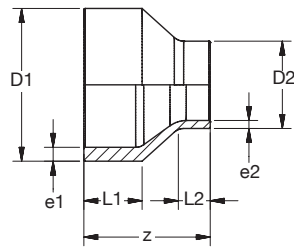

BR PP-INDUSTRIAL Reduktion kurz st **SDR11** grau

BR PP-INDUSTRIAL Reducer short butt **SDR11** grey

Art Nr	D1-D2	e1	e2	L1	L2	z	KG	VE1	VE2
Art No	[mm]	[mm]		[mm]				PU1	PU2
5325 0807 18	32-25	3,0	2,3	16	14	38	0,010	1	370
5325 0907 18	40-25	3,7	2,3	19	14	47	0,016	1	120
5325 0908 18	40-32	3,7	3,0	19	15	39	0,016	1	60
5325 1008 18	50-32	4,6	3,0	18	14	44	0,029	1	200
5325 1009 18	50-40	4,6	3,7	20	19	46	0,029	1	200
5325 1109 28	63-40	5,8	3,7	25	24	60	0,04	1	120
5325 1110 28	63-50	5,8	4,6	25	27	60	0,05	1	120
5325 1210 28	75-50	6,9	4,6	30	28	70	0,07	1	18
5325 1211 28	75-63	6,9	5,8	30	33	70	0,08	1	20
5325 1310 28	90-50	8,2	4,6	35	28	80	0,10	1	16
5325 1311 28	90-63	8,2	5,8	35	32	80	0,10	1	60
5325 1312 28	90-75	8,2	6,9	35	36	80	0,20	1	60
5325 1411 28	110-63	10,0	5,8	35	35	90	0,20	1	30
5325 1412 28	110-75	10,0	6,9	35	38	90	0,20	1	8
5325 1413 28	110-90	10,0	8,2	35	43	90	0,20	1	24
5325 1512 28	125-75	11,4	6,9	40	39	100	0,30	1	36
5325 1513 28	125-90	11,4	8,2	40	43	100	0,30	1	24
5325 1514 28	125-110	11,4	10,0	40	51	100	0,40	1	16
5325 1613 28	140-90	12,7	8,2	50	39	110	0,50	1	8
5325 1614 28	140-110	12,7	10,0	50	45	110	0,50	1	8
5325 1615 28	140-125	12,7	11,4	50	51	110	0,50	1	8
5325 1713 28	160-90	14,6	8,2	55	40	120	0,70	1	8
5325 1714 28	160-110	14,6	10,0	55	44	120	0,70	1	8
5325 1813 28	180-90	16,4	8,2	60	44	130	0,90	1	8
5325 1816 28	180-140	16,4	12,7	60	50	130	0,90	1	8
5325 1817 28	180-160	16,4	14,6	60	58	130	1,00	1	12
5325 1917 28	200-160	18,2	14,6	60	54	140	1,30	1	6
5325 1918 28	200-180	18,2	16,4	60	63	140	1,30	1	10
5325 2017 28	225-160	20,5	14,8	65	58	160	1,80	1	2
5325 2019 28	225-200	20,5	18,2	65	73	160	1,90	1	3
5325 2117 28	250-160	22,8	14,6	75	63	180	2,50	1	2
5325 2119 28	250-200	22,8	18,2	75	72	180	2,50	1	2
5325 2120 28	250-225	22,8	20,5	75	83	180	2,60	1	2
5325 2219 28	280-200	25,4	18,2	85	72	200	3,60	1	3
5325 2220 28	280-225	25,4	20,5	85	80	200	3,70	1	3
5325 2221 28	280-250	25,4	22,7	85	90	200	3,80	1	5
5325 2320 28	315-225	28,6	20,5	95	88	230	5,20	1	2
5325 2321 28	315-250	28,6	22,7	95	95	230	5,30	1	3
5325 2322 28	315-280	28,6	25,5	95	107	230	5,40	1	4

5.03.04 Übergänge • Transitions

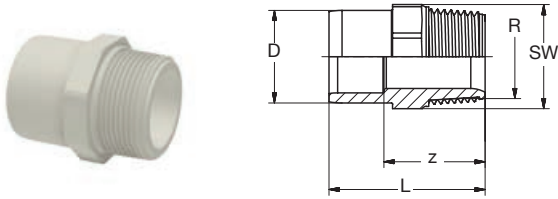

BR PP-INDUSTRIAL Übergang kurz AG-keg st **SDR11** grau

BR PP-INDUSTRIAL Transition short male-thread-con butt **SDR11** grey

Art Nr	D x R	L	z	SW	KG	VE1	VE2
Art No	[mm x Inch]	[mm]				PU1	PU2
5615 0773 18	25 x 1/2	45	29	30	0,017	1	130
5615 0775 18	25 x 3/4	47	31	32	0,019	1	100
5615 0875 18	32 x 3/4	50	31	32	0,026	1	100
5615 0876 18	32 x 1	54	35	36	0,031	1	50
5615 0976 18	40 x 1	58	36	46	0,044	1	60
5615 0977 18	40 x 1 1/4	60	38	46	0,049	1	100
5615 1077 18	50 x 1 1/4	65	39	55	0,069	1	60
5615 1078 18	50 x 1 1/2	66	40	55	0,075	1	60
5615 1178 18	63 x 1 1/2	73	42	65	0,116	1	60
5615 1180 18	63 x 2	78	47	65	0,133	1	60

5.03.05 Verschraubungen • Unions

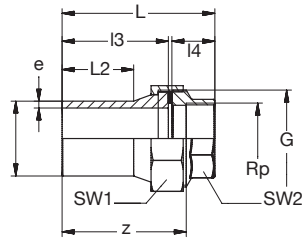

BR PP-INDUSTRIAL-V2A Ü-Verschraubung lang IG-zyl Flachdichtring-EPDM 20°C/1,0MPa st **SDR11** grau

BR PP-INDUSTRIAL-Stainless steel Transition-Union long female-thread-cyl flat-gasket-EPDM 20°C/1.0MPa butt **SDR11** grey

Art Nr	D x Rp	e	G	L	L2	I3	I4	z	SW1	SW2	KG	VE1
Art No	[mm x Inch]	[mm]	[Inch]	[mm]							PU1	
5V53 0745 18	25 x 3/4	2,3	1 1/4	82	36	56	23	67	47	32	0,23	1
5V53 0846 18	32 x 1	3,0	1 1/2	94	42	65	26	77	52	38	0,28	1
5V53 0947 18	40 x 1 1/4	3,7	2	102	45	71	28	83	66	47	0,45	1
5V53 1048 18	50 x 1 1/2	4,6	2 1/4	113	52	81	29	94	72	53	0,61	1
5V53 1150 18	63 x 2	5,8	2 3/4	126	57	89	34	102	87	65	1,07	1
5V53 1253 18	75 x 2 1/2	6,9	3 1/2	179	71	130	46	152	109	82	1,67	1
5V53 1355 18	90 x 3	8,2	4	205	76	150	52	175	123	96	2,29	1
5V53 1357 18	90 x 4	8,2	5	219	76	164	60	180	150	123	3,10	1
5V53 1457 18	110 x 4	10,0	5	233	88	170	60	197	150	123	3,56	1

V2A = 1.4305

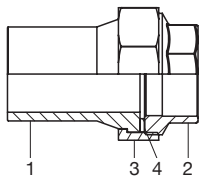

Rohrverschraubung PP-INDUSTRIAL-V2A mit Flachdichtring und Anschluss für Metallgewinde

1. PP Einlegeeteil
2. V2A Einschraubteil
3. V2A Überwurfmutter
4. Flachdichtring-EPDM

Union PP-INDUSTRIAL-Stainless steel with flat gasket and connection for metal thread

1. PP Insert-part
2. Stainless steel Screw-part
3. Stainless steel Union-nut
4. Flat-gasket-EPDM

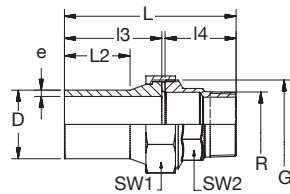

BR PP-INDUSTRIAL-V2A Ü-Verschraubung lang AG-keg Flachdichtring-EPDM 20°C/1,0MPa st **SDR11** grau

BR PP-INDUSTRIAL-Stainless steel Transition-Union long male-thread-con flat-gasket-EPDM 20°C/1.0MPa butt **SDR11** grey

Art Nr	D x R	e	G	L	L2	I3	I4	SW1	SW2	KG	VE1
Art No	[mm x Inch]	[mm]	[Inch]	[mm]							PU1
5V53 0775 18	25 x 3/4	2,3	1 1/4	109	36	56	50	47	27	0,26	1
5V53 0876 18	32 x 1	3,0	1 1/2	122	42	65	54	52	34	0,38	1
5V53 0977 18	40 x 1 1/4	3,7	2	128	45	71	54	66	43	0,59	1
5V53 1078 18	50 x 1 1/2	4,6	2 1/4	146	52	81	62	72	50	0,77	1
5V53 1180 18	63 x 2	5,8	2 3/4	161	57	89	69	87	61	1,19	1
5V53 1283 18	75 x 2 1/2	6,9	3 1/2	152	71	130	78	109	82	2,02	1
5V53 1385 18	90 x 3	8,2	4	240	76	150	87	123	96	2,61	1
5V53 1387 18	90 x 4	8,2	5	257	76	164	100	150	124	3,90	1
5V53 1487 18	110 x 4	10,0	5	273	88	170	100	150	124	4,44	1

V2A = 1.4305

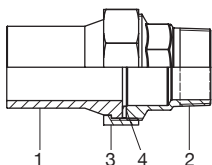

Rohrverschraubung PP-INDUSTRIAL-V2A mit Flachdichtring und Anschluss für Metallgewinde

1. PP Einlegeeteil
2. V2A Einschraubteil
3. V2A Überwurfmutter
4. Flachdichtring-EPDM

Union PP-INDUSTRIAL-Stainless steel with flat gasket and connection for metal thread

1. PP Insert-part
2. Stainless steel Screw-part
3. Stainless steel Union-nut
4. Flat-gasket-EPDM

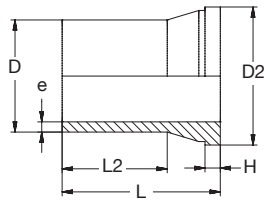

BR PP-INDUSTRIAL Verschraubung Einlegeteil lang st **SDR11** grau
 BR PP-INDUSTRIAL Union Insert-part long butt **SDR11** grey

Art Nr	D	e	D2	L	L2	H	KG	VE1	VE2
Art No	[mm]							PU1	PU2
5353 07E0 18	25	2,3	39	87	66	6	0,023	1	-
5353 08E0 18	32	3,0	45	95	66	7	0,036	1	-
5353 09E0 18	40	3,7	57	97	66	8	0,062	1	-
5353 10E0 18	50	4,6	62	115	80	8	0,10	1	-
5353 11E0 18	63	5,8	78	125	85	9	0,17	1	-
5353 12E0 18	75	6,9	97	130	90	12	0,26	1	-
5353 13E0 18	90	8,2	109	144	103	13	0,38	1	-
5353 14E0 18	110	10,0	135	158	105	13	0,62	1	-

5.03.06 Flanschverbindung • Flange connection

Vorschweißbund (V-Bund) kurz in gerillter Ausführung für den Einsatz von Flachdichtungen.

Weitere Informationen zu Flanschen und Dichtungen finden Sie unter Zubehör.

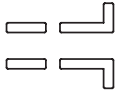

Flange adaptor spigot short in grooved design for the use of flat-gaskets.

More information about flanges and gaskets see Accessories.

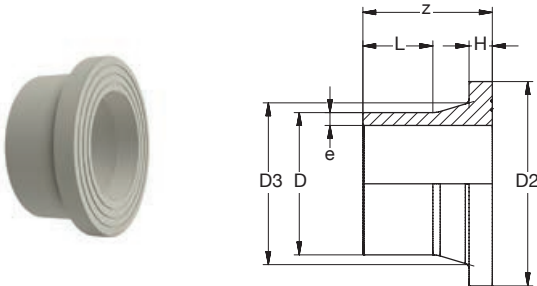

BR PP-INDUSTRIAL V-Bund kurz gerillt st **SDR11** grau

BR PP-INDUSTRIAL Flange adaptor spigot short grooved butt **SRD11** grey

Art Nr	D	e	D2	D3	H	L min	z	KG	VE1	VE2
Art No	[mm]								PU1	PU2
5335 07F0 18	25	2,3	58	33	9	18	35	0,031	10	170
5335 08F0 18	32	3,0	68	40	10	18	35	0,043	10	140
5335 09F0 18	40	3,7	78	50	11	18	40	0,064	10	150
5335 10F0 18	50	4,6	88	61	12	18	60	0,095	10	90
5335 11F0 18	63	5,8	102	75	14	18	78	0,16	2	12
5335 12F0 18	75	6,9	122	89	16	28	78	0,25	2	36
5335 13F0 18	90	8,2	138	105	17	29	88	0,35	2	24
5335 14F0 18	110	10,0	158	125	18	41	100	0,54	2	12
5335 15F0 18	125	11,4	158	132	25	48	110	0,66	2	10
5335 16F0 18	140	12,7	188	155	25	54	116	0,97	2	8
5335 17F0 18	160	14,6	212	175	25	55	127	1,25	2	6
5335 18F0 18	180	16,4	212	180	30	60	138	1,46	2	4
5335 19F0 18	200	18,2	268	232	32	67	145	2,48	1	-
5335 20F0 18	225	20,5	268	235	32	72	148	2,52	1	-
5335 21F0 18	250	22,7	320	285	35	77	158	3,86	1	-
5335 22F0 18	280	25,4	320	291	35	81	180	4,29	1	-
5335 23F0 18	315	28,6	370	335	35	95	188	6,00	1	-

Zubehör Flanschverbindung V-Bund PP-INDUSTRIAL
Accessories Flange Connection spigot PP-INDUSTRIAL



Losflansch
Flange loose



Blindflansch
Flange blind

D [mm]	DN [mm]	PP-St			PP-GGG	PP-St
		DIN/EN			ANSI	
		PN10/16	PN10	PN16	150 lbs	
25	20	9141 07E1 15			9141 07A2 38	
32	25	9141 08E1 15			9141 08A2 38	
40	32	9141 09E1 15			9141 09A2 38	
50	40	9141 10E1 15			9141 10A2 38	
63	50	9141 11E1 15		9151 11A2 25		
75	65	9141 12E1 15			9141 12A2 38	
90	80	9143 13E1 15		9153 13A2 25		
110	100	9143 14E1 15		9153 14A2 25		
125	100	9143 15E1 15			9143 14A2 38	
140	125	9143 16E1 15				
160	150	9143 17E1 15		9153 17A2 25		
180	150	9143 18E1 15		9153 18A2 35		
200	200		9143 19E2 15	9143 19E3 35	9153 19A2 25	
225	200		9143 20E2 15	9143 20E3 35	9153 19A2 25	
250	250		9143 21E2 15	9143 21E3 35	9153 21A2 25	
280	250		9143 22E2 15	9143 22E3 35		
315	300		9143 23E2 15	9143 23E3 35	9153 23A2 25	

D [mm]	DN [mm]	PP-St		
		DIN/EN		ANSI
		PN10/16	PN10	150 lbs
25	20	9144 07E1 35		9144 07A2 38
32	25	9144 08E1 35		9144 08A2 38
40	32	9144 09E1 35		9144 09A2 38
50	40	9144 10E1 35		9144 10A2 38
63	50	9144 11E1 35		9144 11A2 38
75	65	9144 12E1 35		9144 12A2 38
90	80	9144 13E1 35		9144 13A2 38
110	100	9144 14E1 35		9144 14A2 38
125	100	9144 14E1 35		
140	125	9144 16E1 35		
160	150	9144 17E1 35		9144 17A2 38
180	150	9144 17E1 35		
200	200		9144 19E2 35	9144 19A2 38
225	200		9144 19E2 35	
250	250		9144 21E2 35	9144 21A2 38
280	250		9144 21E2 35	
315	300		9144 23E2 35	9144 23A2 38



Flachdichtring mit Stahl-Einlage
Flat gasket with steel-inlay

D [mm]	DN [mm]	EPDM-St	NBR-St
		Wasser/Water	Gas/Gas
		SDR11	SDR11
25	20	9203 07F1 35	9203 07F2 35
32	25	9203 08F1 35	9203 08F2 35
40	32	9203 09F1 35	9203 09F2 35
50	40	9203 10F1 35	9203 10F2 35
63	50	9203 11F1 35	9203 11F2 35
75	65	9203 12F1 35	9203 12F2 35
90	80	9203 13F1 35	9203 13F2 35
110	100	9203 14F1 35	9203 14F2 35
125	100	9203 15F1 35	9203 15F2 35
140	125	9203 16F1 35	9203 16F2 35
160	150	9203 17F1 35	9203 17F2 35
180	150	9203 18F1 35	9203 18F2 35
200	200	9203 19F1 35	9203 19F2 35
225	200	9203 20F1 35	9203 20F2 35
250	250	9203 21F1 35	9203 21F2 35
280	250	9203 22F1 35	9203 22F2 35
315	300	9203 23F1 35	9203 23F2 35



PP-INDUSTRIAL Ventil Schrägsitz mit Handrad Dichtung-EPDM/FKM grau

DN 15 - 50

Schrägsitzventile aus PP sind besonders geeignet als Absperr- und Sicherheitsorgane an Behältern, Rohrleitungen und Pumpenanlagen, insbesondere wo aggressive Medien abzusperrern und zu fördern sind. Die Entstehung von Druckschlägen wird durch das langsame Öffnen der Armatur (Spindelführung) verhindert. Eingesetzt werden diese beispielsweise in der Chemischen Industrie, der Wasser/Abwassertechnik, in Beizanlagen und Abluftreinigungsanlagen.



Flanschanschluß nach DIN 2501 - PN10
Flange connection acc. DIN 2501 - PN10

D [mm]	DN [mm]	DN [Inch]	PN [bar]	KG	Art Nr	
					Art Nr	Art No
EPDM						
20	15	1/2	10	0,40	593F 061H 38	
25	20	3/4	10	0,46	593F 071H 38	
32	25	1	10	0,62	593F 081H 38	
40	32	1 1/4	10	1,03	593F 091H 38	
50	40	1 1/2	10	1,38	593F 101H 38	
63	50	2	10	2,00	593F 111H 38	
FKM						
20	15	1/2	10	0,40	593F 063H 38	
25	20	3/4	10	0,46	593F 073H 38	
32	25	1	10	0,62	593F 083H 38	
40	32	1 1/4	10	1,03	593F 093H 38	
50	40	1 1/2	10	1,38	593F 103H 38	
63	50	2	10	2,00	593F 113H 38	

PP-INDUSTRIAL Valve angle with hand wheel sealing-EPDM/FKM grey

DN 15 - 50

Inclined-seat valves are made of PP. They are safety devices on containers, pipelines, and pumping plants, particularly when aggressive media have to be controlled. Inclined-seat valves cause almost no water hammer when they are opened. Applications include the chemical industry, pickling plants, exhaust air decontamination plants, and water/waste water processing plants.



Verschraubung mit Schweißstumpf
Union with butt-welding spigot

KG	Art Nr	
	Art Nr	Art No
EPDM		
0,23	5933 061H 38	
0,27	5933 071H 38	
0,36	5933 081H 38	
0,60	5933 091H 38	
0,85	5933 101H 38	
1,37	5933 111H 38	
FKM		
0,23	5933 063H 38	
0,27	5933 073H 38	
0,36	5933 083H 38	
0,60	5933 093H 38	
0,85	5933 103H 38	
1,37	5933 113H 38	



Verschraubung mit Schweißmuffen
Union with welding-socket

KG	Art Nr	
	Art Nr	Art No
EPDM		
0,22	5931 061H 38	
0,26	5931 071H 38	
0,34	5931 081H 38	
0,56	5931 091H 38	
0,77	5931 101H 38	
1,26	5931 111H 38	
FKM		
0,22	5931 063H 38	
0,26	5931 073H 38	
0,34	5931 083H 38	
0,56	5931 093H 38	
0,77	5931 103H 38	
1,26	5931 113H 38	

PP-INDUSTRIAL Ventil Schrägsitz Rückschlag Dichtung-EPDM/FKM grau

DN 15 - 50

Die Schrägsitz Rückschlagventile aus PP zeichnen sich durch ihre Zuverlässigkeit und ihre lagenunabhängige Funktionsweise aus. Diese Funktion und gleichzeitig einfache Wartungsmöglichkeit garantiert ein hohes Maß an Prozesssicherheit.



Flanschanschluß nach DIN 2501 - PN10
Flange connection acc. DIN 2501 - PN10

D [mm]	DN [mm]	DN [Inch]	PN [bar]	KG	Art Nr	
					Art Nr	Art No
EPDM						
20	15	1/2	10	0,32	593F 061R 38	
25	20	3/4	10	0,40	593F 071R 38	
32	25	1	10	0,62	593F 081R 38	
40	32	1 1/4	10	1,03	593F 091R 38	
50	40	1 1/2	10	1,38	593F 101R 38	
63	50	2	10	2,00	593F 111R 38	
FKM						
20	15	1/2	10	0,32	593F 063R 38	
25	20	3/4	10	0,40	593F 073R 38	
32	25	1	10	0,62	593F 083R 38	
40	32	1 1/4	10	1,03	593F 093R 38	
50	40	1 1/2	10	1,38	593F 103R 38	
63	50	2	10	2,00	593F 113R 38	

PP-INDUSTRIAL Valve angle Non-return sealing-EPDM/FKM grey

DN 15 - 50

The Non-return Valves made of PP show their strength with remarkable reliability. The valves work in either vertical or horizontal position. Because of its position-independent function and the simple maintenance process, the valve grants a high degree of process reliability.



Verschraubung mit Schweißstumpf
Union with butt-welding spigot

KG	Art Nr	
	Art Nr	Art No
EPDM		
0,23	5933 061R 38	
0,27	5933 071R 38	
0,36	5933 081R 38	
0,60	5933 091R 38	
0,85	5933 101R 38	
1,37	5933 111R 38	
FKM		
0,23	5933 063R 38	
0,27	5933 073R 38	
0,36	5933 083R 38	
0,60	5933 093R 38	
0,85	5933 103R 38	
1,37	5933 113R 38	



Verschraubung mit Schweißmuffen
Union with welding-socket

KG	Art Nr	
	Art Nr	Art No
EPDM		
0,22	5931 061R 38	
0,26	5931 071R 38	
0,34	5931 081R 38	
0,56	5931 091R 38	
0,77	5931 101R 38	
1,26	5931 111R 38	
FKM		
0,22	5931 063R 38	
0,26	5931 073R 38	
0,34	5931 083R 38	
0,56	5931 093R 38	
0,77	5931 103R 38	
1,26	5931 113R 38	

PP-INDUSTRIAL Schmutzfänger Dichtung-EPDM/FKM grau

DN 15 - 50

Um Armaturen, Sensoren und Pumpen gegen Verschmutzung zu schützen wird der Einsatz von Schmutzfängern aus PP empfohlen. Dies stellt eine lange Lebensdauer und Betriebssicherheit der Komponenten sicher.



Flanschanschluß nach DIN 2501 - PN10
Flange connection acc. DIN 2501 - PN10

D [mm]	DN [mm]	DN [Inch]	PN [bar]	KG	Art Nr	Art No
EPDM						
20	15	1/2	10	0,30	593F 061S 38	
25	20	1	10	0,37	593F 071S 38	
32	25	1	10	0,50	593F 081S 38	
40	32	1 1/4	10	0,83	593F 091S 38	
50	40	1 1/2	10	1,10	593F 101S 38	
63	50	2	10	1,50	593F 111S 38	
FKM						
20	15	1/2	10	0,30	593F 062S 38	
25	20	1	10	0,37	593F 072S 38	
32	25	1	10	0,50	593F 082S 38	
40	32	1 1/4	10	0,83	593F 092S 38	
50	40	1 1/2	10	1,10	593F 102S 38	
63	50	2	10	1,50	593F 112S 38	

PP-INDUSTRIAL Line strainer sealing-EPDM/FKM grey

DN 15 - 50

To protect valves, sensors and pumps from pollutants, we recommended the use of Strainers made of PP. This ensures reliable operation and extended service life for your components.



Verschraubung mit Schweißstumpf
Union with butt-welding spigots

KG	Art Nr	Art No
EPDM		
0,13	5933 061S 38	
0,17	5933 071S 38	
0,24	5933 081S 38	
0,40	5933 091S 38	
0,60	5933 101S 38	
0,95	5933 111S 38	
FKM		
0,13	5933 062S 38	
0,17	5933 072S 38	
0,24	5933 082S 38	
0,40	5933 092S 38	
0,60	5933 102S 38	
0,95	5933 112S 38	



Verschraubung mit Schweißmuffen
Union with welding-sockets

KG	Art Nr	Art No
EPDM		
0,12	5931 061S 38	
0,16	5931 071S 38	
0,22	5931 081S 38	
0,36	5931 091S 38	
0,51	5931 101S 38	
0,85	5931 111S 38	
FKM		
0,12	5931 062S 38	
0,16	5931 072S 38	
0,22	5931 082S 38	
0,36	5931 092S 38	
0,51	5931 102S 38	
0,85	5931 112S 38	

PP-INDUSTRIAL Absperrklappen Dichtung-EPDM/FKM grau

DN 65 - 300

Absperrklappen aus PP sind dichtschießende Armaturen. Sie werden überall dort eingesetzt, wo große Mengen flüssiger Medien sicher transportiert werden, wie z.B. in der Wasseraufbereitung oder in der chemischen Industrie. Unsere Klappen sind modular aufgebaut und ermöglichen Ihnen jederzeit einen Austausch einzelner Systemteile, das alles schnell, einfach und ohne großen Aufwand. Maximal zulässige Betriebstemperatur PP: 80°C.

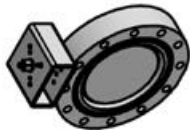

mit freiem Wellenende
with free shaft end

D [mm]	DN [mm]	DN [Inch]	PN [bar]	KG	Art Nr	Art No
EPDM						
75	65	2 1/2	10	0,90	595F 121W 38	
90	80	3	10	1,00	595F 131W 38	
110	100	4	10	1,50	595F 141W 38	
160	150	6	8	2,80	595F 171W 38	
225	200	8	6	3,90	595F 201W 38	
280	250	10	6	6,50	595F 221W 38	
315	300	12	5	11,50	595F 231W 38	
FKM						
75	65	2 1/2	10	0,90	595F 123W 38	
90	80	3	10	1,00	595F 133W 38	
110	100	4	10	1,50	595F 143W 38	
160	150	6	8	2,80	595F 173W 38	
225	200	8	6	3,90	595F 203W 38	
280	250	10	6	6,50	595F 223W 38	
315	300	12	5	11,50	595F 233W 38	



mit Handrad + Schneckengetriebe
with hand-wheel + wormgear

KG	Art Nr	Art No
EPDM		
3,10	595F 121S 38	
3,30	595F 131S 38	
3,80	595F 141S 38	
5,00	595F 171S 38	
6,20	595F 201S 38	
13,50	595F 221S 38	
18,50	595F 231S 38	
FKM		
3,10	595F 123S 38	
3,30	595F 133S 38	
3,80	595F 143S 38	
5,00	595F 173S 38	
6,20	595F 203S 38	
13,50	595F 223S 38	
18,50	595F 233S 38	



mit Handhebel + Feststellvorrichtung
with manual lever + fixing device

KG	Art Nr	Art No
EPDM		
1,10	595F 121H 38	
1,20	595F 131H 38	
1,80	595F 141H 38	
3,00	595F 171H 38	
4,80	595F 201H 38	
FKM		
1,10	595F 123H 38	
1,20	595F 133H 38	
1,80	595F 143H 38	
3,00	595F 173H 38	
4,80	595F 203H 38	

PP-INDUSTRIAL Butterfly shut-off valves sealing-EPDM/FKM grey

DN 65 - 300

The plastic shut-off valves made of PP are leakage free. They can be used wherever large volumes of liquids need to be conveyed safely and reliably, e.g. water treatment or in chemical process industries. Our valves modular design principle allows you to exchange individual system components, fast, easily and at very little expense and effort. Max. operating temperature PP: 80°C.





6 CFR FIRETEC

Kunststoffrohre und Formteile der Produktlinie CFR FIRETEC bestehen aus dem Werkstoff PP-RCT (alpha-nukleiert) mit einem Flammschutz-Additiv und können somit zur Erstellung von Feuerlöschleitungssystemen für den Anschluss von Sprinkler und Hydranten verwendet werden. Die Verwendung ist entsprechend den nationalen Regelungen und Verordnungen zu prüfen.

Alle FIRETEC-Rohre haben dank Ihrer Faser-Mittelschicht eine deutlich reduzierte Längenausdehnung gegenüber Vollwandrohren und können ohne vorherige Arbeitsschritte direkt verschweißt werden.

Das System ist zertifiziert durch AENOR.

Eigenschaften

- Korrosionsbeständigkeit
- Hervorragende Verarbeitbarkeit
- Sehr gute Druck- und Temperaturbeständigkeit
- Geeignet für Feuerlöschleitungssysteme

Werkstoff

PP-RCT FR (CFR) mit erhöhter Temperaturbeständigkeit und Flammschutz-Additiv, alpha-nukleiert, RAL 3000 Feuerrot, Feuerwiderstandsklasse B-s1,d0 (EN 13501), halogenfrei.

Verbindungstechnik

- Heizelement-Muffen-Schweißung
- Heizwendel-Muffen-Schweißung
- Flanschverbindung

Plastic pipes and fittings of the product line CFR FIRETEC consist of the material PP-RCT (alpha-nucleated) with a flame retardant additive and can therefore be used to create fire-fighting pipe systems for the connection of sprinklers and hydrants. The application must be checked in accordance with the national regulations and directives.

Due to the fiber middle-layer, all FIRETEC pipes have a significantly reduced linear expansion compared to solid wall pipes and can be welded directly without a prior processing step.

The system is certified by AENOR.

Properties

- Corrosion resistance
- Excellent processing capability
- Excellent pressure and temperature resistance
- Applicable for fire-fighting pipe systems

Material

PP-RCT FR (CFR) with increased temperature resistance and flame retardant additive, alpha-nucleated, RAL 3000 fire red, fire reaction classification B-s1,d0 (EN 13501), halogen free.

Joining technology

- Socket-welding
- Electrofusion socket-welding
- Flange connection



6.01 Rohre mehrlagig · Pipes multi-layer **CFR 3**



6.02 Formteile Muffenschweißen
Fittings socket-welding **CFR 4**

6.02.01 Winkel
Elbows **CFR 4**

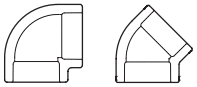

6.02.07 Flanschverbindung
Flange connection **CFR 9**



6.02.02 T-Stücke, Abzweige
Tee's, Branches **CFR 5**

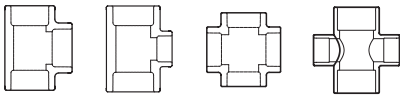

6.02.08 Einschweißsättel
Weld-in-saddles **CFR 10**



6.02.03 Reduktionen, Muffen, Kappen
Reducers, Sockets, Caps **CFR 6**

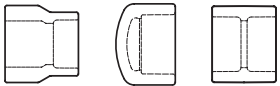

6.02.09 Kugelhähne
Ball valves **CFR 10**

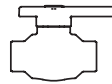

6.02.04 Übergänge
Transitions **CFR 7**

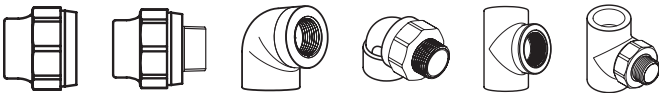

6.02.05 Übergänge Wand
Transitions wall **CFR 8**



6.02.06 Verschraubungen
Unions **CFR 9**

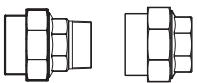

6.01 Rohre mehrlagig • Pipes multi-layer

Beschreibung

CFR Druckrohr FIRETEC, mehrlagig, mit Faser-Mittelschicht zur Reduzierung der axialen Ausdehnung, SDR7,4 und 11.

Für hohe Drücke und hohe Temperaturen, bei gleichzeitigem hohem Durchfluss und reduzierter Längenausdehnung.

Faser-Rohre können, analog zu Vollwandrohren, ohne vorherigen Bearbeitungsschritt direkt verschweißt werden.

Werkstoff

PP-RCT FR (CFR) mit erhöhter Temperaturbeständigkeit und Flammschutz-Additiv, alpha-nukleiert, RAL 3000 Feuerrot, Feuerwiderstandsklasse B-s1,d0 (EN 13501), halogenfrei.

Geometrische Eigenschaften

Abmessungen und Toleranzen entsprechend DIN 8077 und DIN EN 15874-2.

Betriebsdruck (50 Jahre, SF 1,25)

SDR7,4 = 20°C/3,17 MPa

SDR11 = 20°C/2,03 MPa.

Ausführung

Geeignet für Heizelement-Muffen-Schweißung, Heizelement-Stumpf-Schweißung und Heizwendel-Muffen-Schweißung nach DVS Richtlinie 2207. Schweiß-Geräte und Schweiß-Werkzeuge sollten der DVS Richtlinie 2208 entsprechen.

Zertifizierung

Rohrsysteme aus Polypropylen mit Glasfaser für Feuerlösch-Leitungssysteme mit Hydranten und Sprinklern; entsprechend AENOR RP 001.84.

Lieferung

In 4 m Stangen; abgepackt in Bündeln. Alle Bündel sind in einer Schlauchfolie verpackt. Abgabe erfolgt nur in kompletten Verpackungseinheiten (VE's).

Description

CFR Pressure pipe FIRETEC, multi-layer, with Fiber-middle-layer for reduced axial expansion, SDR7.4 and 11.

For high pressures and high temperatures with simultaneous high flow and reduced expansion.

Fiber-pipes can be, analogue to solid wall pipes, directly welded without a prior processing step.

Material

PP-RCT FR (CFR) with increased temperature resistance and flame retardant additive, alpha-nucleated, RAL 3000 fire red, fire reaction classification B-s1,d0 (EN 13501), halogen free.

Geometric Properties

Dimensions and tolerances according to DIN 8077 and DIN EN ISO 15874-2.

Operating Pressure (50 years, SF 1,25)

SDR7.4 = 20°C / 3.17 MPa

SDR11 = 20°C / 2.03 MPa.

Type

Useable for socket-welding, butt-welding and electrofusion-socket-welding according to DVS technical code 2207. Welding equipment according to DVS technical code 2208.

Certification

Piping systems Polypropylene and fiberglass for fire protection installations by hydrants and sprinkler; according to AENOR RP 001.84.

Delivery

In 4 m rods; packed in bundles. All bundles are packed in protection-foil. Supply only in complete packing units (PU's).

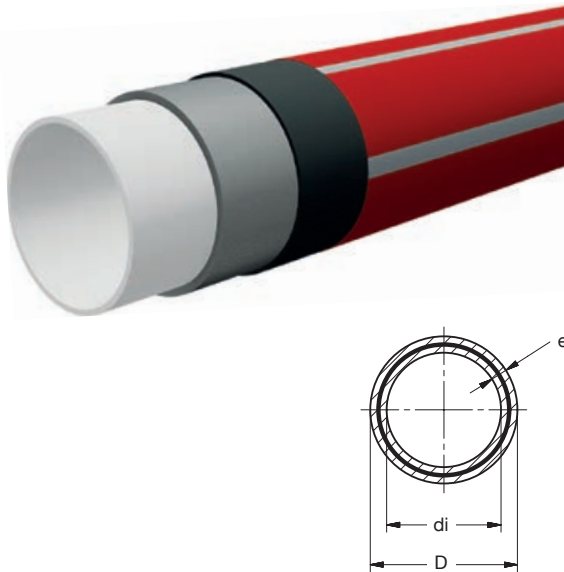

BR CFR Druckrohr FIRETEC 1,6MPa rot

BR CFR Pressure pipe FIRETEC 1.6MPa red

Art Nr	D	e	DN	di	SDR	L	KG	VE1	VE2
Art No	[mm]		[mm]			[m]		PU1	PU2
6F12 0640 2F	20	2,8	15	14,4	7,4	4	0,150	160	
6F12 0740 2F	25	3,5	20	18,0	7,4	4	0,233	100	
6F12 0840 2F	32	4,4	25	23,2	7,4	4	0,375	60	
6F14 0940 2F	40	3,7	32	32,6	11	4	0,445	40	
6F14 1040 2F	50	4,6	40	40,8	11	4	0,682	20	
6F14 1140 2F	63	5,8	50	51,4	11	4	1,03	12	
6F14 1240 2F	75	6,8	-	61,4	11	4	1,44	8	
6F14 1340 2F	90	8,2	65	73,6	11	4	2,08	8	
6F14 1440 2F	110	10,0	80	90,0	11	4	3,10	4	
6F14 1540 2F	125	11,4	100	102,2	11	4	4,01	4	
6F14 1740 2F	160*	14,6	125	130,8	11	4	6,56	4	

* Kein Lagerartikel • Not a stock item

6.02 Formteile Muffen-Schweißen • Fittings socket-welding

Beschreibung

Gespritzte Formteile (ohne Verschwächungsbeiwerte), für die Heizelement-Muffen-Schweißung.

Werkstoff

PP-RCT FR (CFR) mit erhöhter Temperaturbeständigkeit und Flammschutz-Additiv, alpha-nukleiert, RAL 3000 Feuerrot, Feuerwiderstandsklasse B-s1,d0 (EN 13501), halogenfrei. Metallteile aus Messing CW617N (CuZn40Pb2).

Geometrische Eigenschaften

Abmessungen und Toleranzen der Muffen entsprechend DIN EN ISO 15874-3.

Betriebsdruck

Der Betriebsdruck richtet sich üblicherweise nach dem eingesetzten Rohr. Grundsätzlich sind alle Standard-Formteile für die angebotenen Rohre geeignet.

Ausführung

Geeignet für Heizelement-Muffen-Schweißung nach DVS Richtlinie 2207. Schweißgeräte und Schweiß-Werkzeuge sollten der DVS Richtlinie 2208 entsprechen.

Zertifizierung

Rohrsysteme aus Polypropylen mit Glasfaser für Feuerlösch-Leitungssysteme mit Hydranten und Sprinklern; entsprechend AENOR RP 001.84.

Lieferung

Abgabe erfolgt nur in kompletten Verpackungseinheiten (VE's).

Formteile d160 auf Anfrage.

Description

Injection moulded fittings (without pressure reduction factors), for socket-welding.

Material

PP-RCT FR (CFR) with increased temperature resistance and flame retardant additive, alpha-nucleated, RAL 3000 fire red, fire reaction classification B-s1,d0 (EN13501), halogen free. Metal inserts made of brass CW617N (CuZn40Pb2).

Geometric Properties

Dimensions and tolerances of the sockets according to DIN EN ISO 15874-3.

Operating pressure

The operating pressure usually depends on the used pipe. Basically, all standard fittings are suitable for the offered pipes.

Type

Suitable for socket-welding according to DVS technical code 2207. Welding equipment according to DVS technical code 2208.

Certification

Piping systems Polypropylene and fiberglass for fire protection installations by hydrants and sprinkler; according to AENOR RP 001.84.

Delivery

Supply only in complete packing units (PU's).

Fittings d160 on request.

6.02.01 Winkel • Elbows

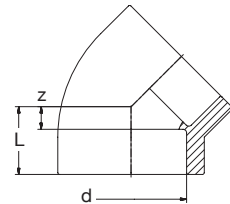
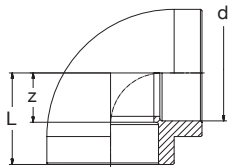

BR CFR Winkel 90° rot

BR CFR Elbow 90° red

Art Nr	d	L	z	KG	VE1	VE2
Art No	[mm]	[mm]	[mm]		PU1	PU2
6411 0690 2F	20	26,5	11,0	0,014	40	400
6411 0790 2F	25	29,7	12,5	0,023	20	200
6411 0890 2F	32	34,1	16,1	0,034	10	100
6411 0990 2F	40	40,5	22,4	0,055	5	75
6411 1090 2F	50	47,5	26,0	0,104	4	40
6411 1190 2F	63	60,1	32,4	0,232	-	20
6411 1290 2F	75	70,9	39,5	0,421	-	40
6411 1390 2F	90	86,0	50,0	0,717	-	24
6411 1490 2F	110	103,5	61,4	1,12	-	14
6411 1590 2F	125	114,5	69,8	1,76	-	12

BR CFR Winkel 45° rot

BR CFR Elbow 45° red

Art Nr	d	L	z	KG	VE1	VE2
Art No	[mm]	[mm]	[mm]		PU1	PU2
6411 0645 2F	20	20,7	5,5	0,012	50	400
6411 0745 2F	25	24,0	6,4	0,020	25	250
6411 0845 2F	32	28,4	7,7	0,029	10	150
6411 0945 2F	40	32,0	10,6	0,065	5	80
6411 1045 2F	50	37,4	13,9	0,109	4	40
6411 1145 2F	63	40,4	12,7	0,166	-	30
6411 1245 2F	75	52,8	21,0	0,316	-	50
6411 1345 2F	90	58,6	23,6	0,524	-	35
6411 1445 2F	110	68,8	26,6	0,847	-	20
6411 1545 2F	125	81,7	37,0	1,376	-	12

6.02.02 T-Stücke, Abzweige • Tee's, Branches

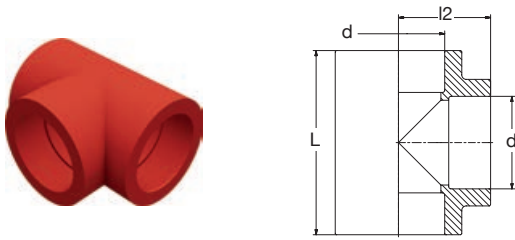

BR CFR T-Stück 90° rot
BR CFR Tee 90° red

Art Nr Art No	d [mm]	L [mm]	l2 [mm]	KG	VE1 PU1	VE2 PU2
6511 0600 2F	20	52,6	26,3	0,020	25	250
6511 0700 2F	25	62,2	31,1	0,030	15	150
6511 0800 2F	32	73,8	36,9	0,056	5	60
6511 0900 2F	40	84,0	42,0	0,084	5	50
6511 1000 2F	50	99,8	49,9	0,153	2	30
6511 1100 2F	63	125,4	62,7	0,335	2	14
6511 1200 2F	75	141,2	70,6	0,522	1	10
6511 1300 2F	90	172,4	86,2	0,851	-	24
6511 1400 2F	110	203,4	101,7	1,54	-	12
6511 1500 2F	125	226,0	113,0	1,25	-	9

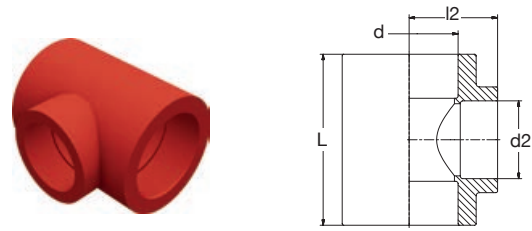

BR CFR T-Stück 90° red. rot
BR CFR Tee 90° red. red

Art Nr Art No	d-d2 [mm]	L [mm]	l2 [mm]	KG	VE1 PU1	VE2 PU2
6521 0706 2F	25-20	59,2	29,3	0,026	20	160
6521 0806 2F	32-20	57,8	33,7	0,036	10	100
6521 0807 2F	32-25	62,2	34,4	0,039	10	100
6521 0906 2F	40-20	85,2	43,5	0,081	5	50
6521 0907 2F	40-25	86,6	41,4	0,087	5	50
6521 0908 2F	40-32	86,6	41,4	0,085	5	50
6521 1007 2F	50-25	78,2	43,2	0,111	3	30
6521 1008 2F	50-32	92,6	45,2	0,136	3	30
6521 1009 2F	50-40	92,4	48,5	0,139	3	30
6521 1107 2F	63-25	91,8	49,6	0,212	2	20
6521 1108 2F	63-32	91,6	50,9	0,213	2	20
6521 1109 2F	63-40	109,2	53,5	0,260	2	20
6521 1110 2F	63-50	110,0	56,9	0,265	2	20
6521 1208 2F	75-32	140,0	60,0	0,520	-	-
6521 1209 2F	75-40	106,0	60,0	0,520	-	-
6521 1210 2F	75-50	120,0	61,8	0,391	-	45
6521 1211 2F	75-63	132,4	68,3	0,471	-	30
6521 1310 2F	90-50	163,0	80,0	0,920	-	-
6521 1311 2F	90-63	158,0	110,0	0,920	-	18
6521 1312 2F	90-75	158,0	79,3	0,751	-	24
6521 1411 2F	110-63	183,0	130,0	1,60	-	10
6521 1412 2F	110-75	183,0	96,0	1,60	-	10
6521 1413 2F	110-90	183,0	90,0	1,20	-	14

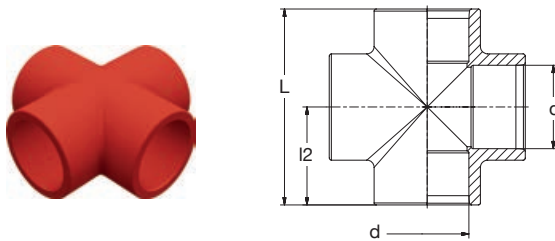

BR CFR Kreuz rot
BR CFR Cross red

Art Nr Art No	d [mm]	L [mm]	l2 [mm]	KG	VE1 PU1	VE2 PU2
6551 0800 2F	32	72	20,5	0,054	60	-
6551 0900 2F	40	84	26,5	0,098	40	-

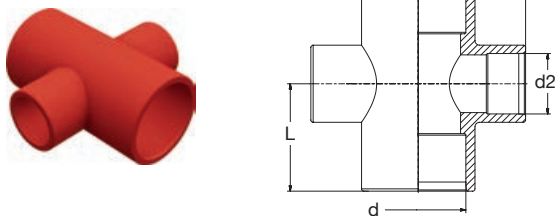

BR CFR Kreuz red. rot
BR CFR Cross red. red

Art Nr Art No	d1-d2 [mm]	L [mm]	KG	VE1 PU1	VE2 PU2
6551 1008 2F	50-32	46,3	0,19	30	-
6551 1108 2F	63-32	45,8	0,26	20	-
6551 1109 2F	63-40	54,6	0,32	20	-
6551 1208 2F	75-32	70,0	0,53	45	-
6551 1209 2F	75-40	53,0	0,41	45	-
6551 1210 2F	75-50	60,0	1,01	45	-
6551 1310 2F	90-50	81,5	0,99	5	-

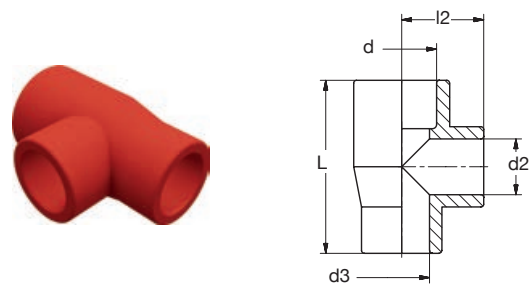

BR CFR T-Stück 90° multi-red. rot
BR CFR Tee 90° multi-red. red

Art Nr Art No	d1-d2-d3 [mm]	L [mm]	l2 [mm]	KG	VE1 PU1	VE2 PU2
6521 07BB 2F	25-20-20	62,0	29,4	0,025	20	160
6521 08CC 2F	32-25-25	57,8	38,2	0,050	10	100

6.02.03 Reduktionen, Muffen, Kappen • Reducers, Sockets, Caps

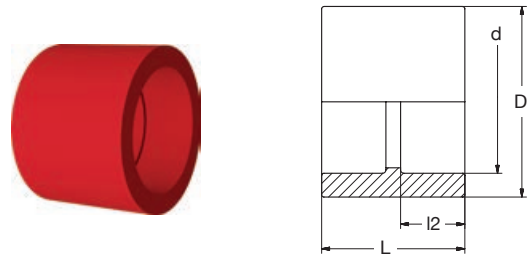
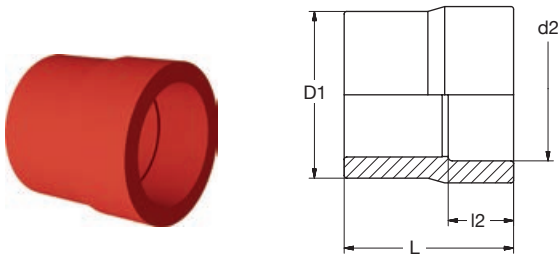

BR CFR Reduktion rot
BR CFR Reducer red

BR CFR Muffe rot
BR CFR Socket red

Art Nr	D1-d2	L	l2	KG	VE1	VE2
Art No	[mm]	[mm]	[mm]		PU1	PU2
6321 0706 2F	25-20	34,4	17,4	0,010	50	500
6321 0806 2F	32-20	37,0	14,4	0,015	30	300
6321 0807 2F	32-25	36,6	18,0	0,014	30	300
6321 0907 2F	40-25	39,4	17,0	0,022	20	200
6321 0908 2F	40-32	51,2	19,0	0,032	20	160
6321 1008 2F	50-32	40,3	18,4	0,035	10	100
6321 1009 2F	50-40	48,0	21,5	0,044	10	100
6321 1107 2F	63-25	63,5	18,4	0,065	5	60
6321 1108 2F	63-32	62,0	23,7	0,070	5	60
6321 1109 2F	63-40	62,0	23,1	0,087	5	60
6321 1110 2F	63-50	64,0	24,7	0,081	5	40
6321 1208 2F	75-32	66,7	23,3	0,142	4	40
6321 1209 2F	75-40	66,7	23,3	0,133	4	40
6321 1210 2F	75-50	66,7	23,3	0,120	4	40
6321 1211 2F	75-63	71,2	30,5	0,154	4	32
6321 1311 2F	90-63	70,0	29,0	0,202	2	20
6321 1312 2F	90-75	77,0	32,0	0,258	2	20
6321 1411 2F	110-63	73,0	26,6	0,267	-	75
6321 1412 2F	110-75	77,2	31,2	0,277	-	75
6321 1413 2F	110-90	94,5	35,5	0,401	-	45
6321 1514 2F	125-110	115,0	38,5	0,702	-	24

Art Nr	d	D	L	l2	KG	VE1	VE2
Art No	[mm]	[mm]	[mm]	[mm]		PU1	PU2
6311 0600 2F	20	28,8	32,8	15,0	0,010	50	500
6311 0700 2F	25	35,6	36,6	16,7	0,020	40	320
6311 0800 2F	32	44,8	42,0	20,0	0,027	15	150
6311 0900 2F	40	54,4	45,8	21,3	0,041	10	100
6311 1000 2F	50	67,4	53,0	23,0	0,074	5	60
6311 1100 2F	63	84,0	63,1	28,3	0,131	4	32
6311 1200 2F	75	101,0	67,5	28,6	0,209	2	24
6311 1300 2F	90	116,2	71,8	33,0	0,281	-	45
6311 1400 2F	110	124,7	98,8	43,4	0,607	-	33
6311 1500 2F	125	162,0	89,4	42,0	0,679	-	24

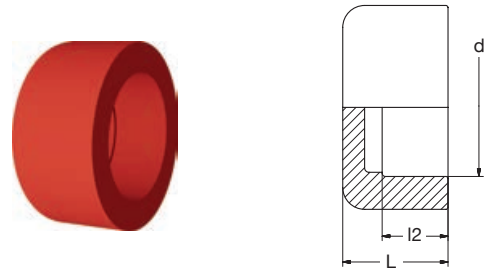

BR CFR Kappe rot
BR CFR Cap red

Art Nr	d	L	l2	KG	VE1	VE2
Art No	[mm]	[mm]	[mm]		PU1	PU2
6341 0600 2F	20	25,0	19,4	0,008	50	500
6341 0700 2F	25	24,5	19,5	0,010	50	500
6341 0800 2F	32	29,0	23,5	0,016	30	300
6341 0900 2F	40	33,6	20,0	0,030	20	160
6341 1000 2F	50	42,0	25,0	0,038	10	100
6341 1100 2F	63	48,0	30,0	0,113	5	50
6341 1200 2F	75	51,2	38,7	0,191	4	32
6341 1300 2F	90	61,4	46,5	0,289	2	24
6341 1400 2F	110	69,0	51,2	0,607	-	15
6341 1500 2F	125	75,6	54,4	0,710	-	32

6.02.04 Übergänge • Transitions

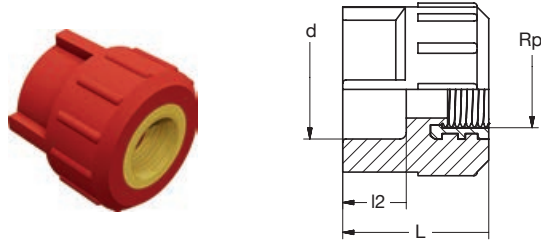

BR CFR-Ms Übergang IG-zyl rot

BR CFR-Brass Transition female-thread-cyl red

Art Nr Art No	d x Rp [mm x Inch]	L	l2	KG	VE1 PU1	VE2 PU2
6M11 0643 2F	20 x 1/2	38,3	15,2	0,045	20	200
6M11 0743 2F	25 x 1/2	41,5	18,0	0,047	10	150
6M11 0745 2F	25 x 3/4	40,0	17,4	0,059	10	150
6M11 0845 2F	32 x 3/4	46,0	20,0	0,086	10	100

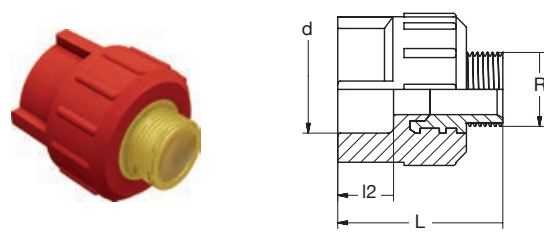

BR CFR-Ms Übergang AG-keg rot

BR CFR-Brass Transition male-thread-con red

Art Nr Art No	d x R [mm x Inch]	L	l2	KG	VE1 PU1	VE2 PU2
6M11 0673 2F	20 x 1/2	50,3	15,2	0,052	20	200
6M11 0675 2F	20 x 3/4	56,5	17,4	0,086	10	100
6M11 0773 2F	25 x 1/2	53,5	18,0	0,054	10	100
6M11 0775 2F	25 x 3/4	53,0	17,4	0,082	10	150
6M11 0875 2F	32 x 3/4	59,0	20,0	0,107	10	100

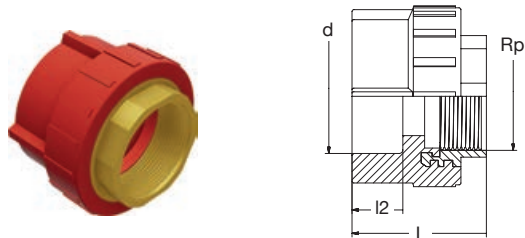

BR CFR-Ms Übergang IG-zyl SW rot

BR CFR-Brass Transition female-thread-cyl SW red

Art Nr Art No	d x Rp [mm x Inch]	L	l2	KG	VE1 PU1	VE2 PU2
6M11 0846 2F	32 x 1	52,3	17,0	0,144	5	80
6M11 0947 2F	40 x 1 1/4	64,3	23,3	0,280	4	40
6M11 1048 2F	50 x 1 1/2	67,6	24,0	0,396	4	40
6M11 1150 2F	63 x 2	76,2	28,0	0,569	2	20
6M11 1253 2F	75 x 2 1/2	83,0	29,8	0,764	1	12
6M11 1355 2F	90 x 3	98,0	35,0	1,018	1	8
6M11 1457 2F	110 x 4	101,0	42,0	1,379	1	5

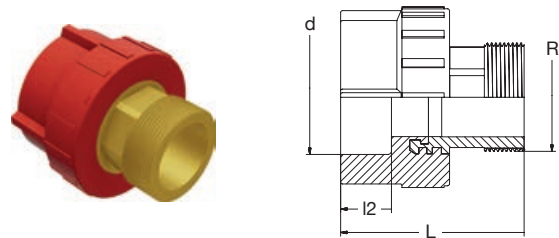

BR CFR-Ms Übergang AG-keg SW rot

BR CFR-Brass Transition male-thread-con SW red

Art Nr Art No	d x R [mm x Inch]	L	l2	KG	VE1 PU1	VE2 PU2
6M11 0876 2F	32 x 1			0,180	5	80
6M11 0977 2F	40 x 1 1/4	81,6	23,3	0,367	4	40
6M11 1078 2F	50 x 1 1/2	86,4	24,0	0,500	4	32
6M11 1180 2F	63 x 2	101,2	28,0	0,650	2	16
6M11 1283 2F	75 x 2 1/2	100,5	29,8	0,871	1	12
6M11 1385 2F	90 x 3	125,0	35,0	1,30	1	8
6M11 1487 2F	110 x 4	133,0	42,0	1,92	1	5

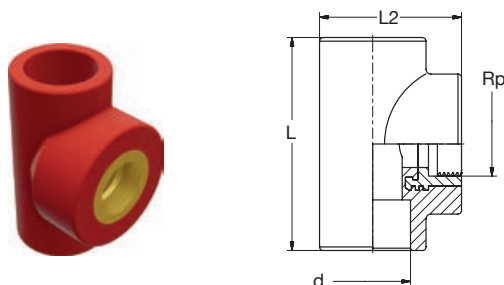

BR CFR-Ms Ü-T-Stück 90° IG-zyl rot

BR CFR-Brass Trans-Tee 90° female-thread-cyl red

Art Nr Art No	d x Rp [mm x Inch]	L	L2	KG	VE1 PU1	VE2 PU2
6M41 0643 2F	20 x 1/2	59	45	0,052	20	160
6M41 0743 2F	25 x 1/2	65	51	0,062	10	100
6M41 0745 2F	25 x 3/4	65	51	0,077	10	100
6M41 0845 2F	32 x 3/4	88	59	0,131	5	50

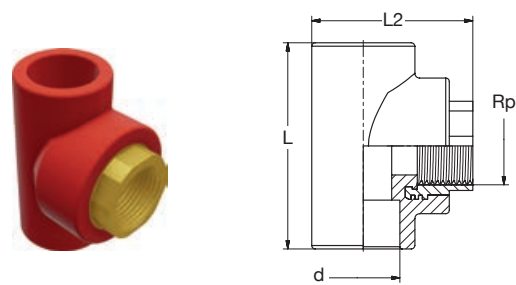

BR CFR-Ms Ü-T-Stück 90° IG-zyl SW rot

BR CFR-Brass Trans-Tee 90° female-thread-cyl SW red

Art Nr Art No	d x Rp [mm x Inch]	L	L2	KG	VE1 PU1	VE2 PU2
6M41 0846 2F	32 x 1	88	69	0,195	5	50

6.02.04 Übergänge • Transitions

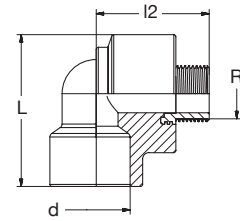
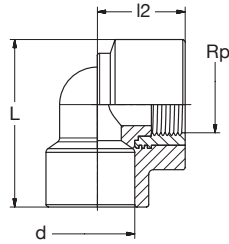

BR CFR-Ms Ü-Winkel 90° IG-zyl rot

BR CFR-Brass Trans-Elbow 90° female-thread-cyl red

Art Nr	d x Rp	L	l2	KG	VE1	VE2
Art No	[mm x Inch]	[mm]	[mm]		PU1	PU2
6M21 0643 2F	20 x 1/2	53	34	0,057	20	200
6M21 0743 2F	25 x 1/2	59	36	0,062	10	150
6M21 0745 2F	25 x 3/4	59	36	0,077	10	150
6M21 0845 2F	32 x 3/4	72	38	0,112	5	50

BR CFR-Ms Ü-Winkel 90° AG-keg rot

BR CFR-Brass Trans-Elbow 90° male-thread-con red

Art Nr	d x R	L	l2	KG	VE1	VE2
Art No	[mm x Inch]	[mm]	[mm]		PU1	PU2
6M21 0673 2F	20 x 1/2	53	46	0,064	20	160
6M21 0675 2F	20 x 3/4	59	51	0,104	10	100
6M21 0775 2F	25 x 3/4	59	51	0,101	10	100
6M21 0875 2F	32 x 3/4	72	53	0,135	5	50

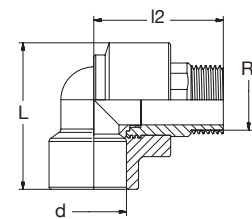
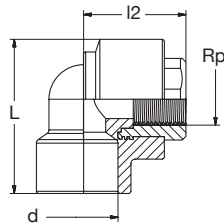

BR CFR-Ms Ü-Winkel 90° IG-zyl SW rot

BR CFR-Brass Trans-Elbow 90° female-thread-cyl SW red

Art Nr	d x Rp	L	l2	KG	VE1	VE2
Art No	[mm x Inch]	[mm]	[mm]		PU1	PU2
6M21 0846 2F	32 x 1	72	48	0,171	5	50

BR CFR-Ms Ü-Winkel 90° AG-keg SW rot

BR CFR-Brass Trans-Elbow 90° male-thread-con SW red

Art Nr	d x R	L	l2	KG	VE1	VE2
Art No	[mm x Inch]	[mm]	[mm]		PU1	PU2
6M21 0876 2F	32 x 1	72	63	0,195	10	50

6.02.05 Übergänge Wand • Transitions wall

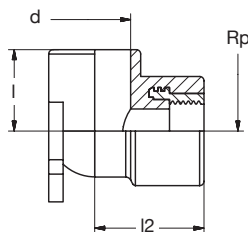

BR CFR-Ms Ü-Winkel 90° Wand IG-zyl rot

BR CFR-Brass Trans-Elbow 90° wall female-thread-cyl red

Art Nr	d x Rp	l	l2	KG	VE1	VE2
Art No	[mm x Inch]	[mm]	[mm]		PU1	PU2
6M31 0643 2F	20 x 1/2	28	37	0,060	15	120
6M31 0743 2F	25 x 1/2	28	41	0,065	15	120

6.02.06 Verschraubungen • Unions



BR CFR-Ms Ü-Verschraubung IG-zyl rot

BR CFR-Brass Trans-Union female-thread-cyl red

Art Nr	d x Rp	L	l2	KG	VE1	VE2
Art No	[mm x Inch]	[mm]			PU1	PU2
6M51 0643 2F	20 x 1/2	38,0	16,0	0,068	20	200
6M51 0745 2F	25 x 3/4	44,4	17,3	0,112	10	100
6M51 0846 2F	32 x 1	45,1	18,6	0,124	10	100
6M51 0947 2F	40 x 1 1/4	47,7	22,0	0,209	5	50
6M51 1048 2F	50 x 1 1/2	48,1	24,0	0,339	4	32
6M51 1150 2F	63 x 2	64,0	29,5	0,730	1	20
6M51 1253 2F	75 x 2 1/2	79,0	32,0	1,340	1	15
6M51 1355 2F	90 x 3	75,1	36,3	1,686	1	8
6M51 1457 2F	110 x 4	94,0	39,0	3,640	1	-

BR CFR-Ms Ü-Verschraubung AG-keg rot

BR CFR-Brass Trans-Union male-thread-con red

Art Nr	d x R	L	l2	KG	VE1	VE2
Art No	[mm x inch]	[mm]			PU1	PU2
6M51 0673 2F	20 x 1/2	50,3	16,0	0,077	20	200
6M51 0775 2F	25 x 3/4	57,0	17,3	0,119	10	100
6M51 0876 2F	32 x 1	57,1	18,6	0,143	10	100
6M51 0977 2F	40 x 1 1/4	63,3	22,0	0,227	4	40
6M51 1078 2F	50 x 1 1/2	66,1	24,0	0,358	4	32
6M51 1180 2F	63 x 2	76,7	28,6	0,611	2	16
6M51 1283 2F	75 x 2 1/2	100,5	32,0	1,500	1	12
6M51 1385 2F	90 x 3	95,5	36,6	1,863	1	8
6M51 1487 2F	110 x 4	118,0	39,0	3,640	1	-

6.02.07 Flanschverbindung • Flange connection

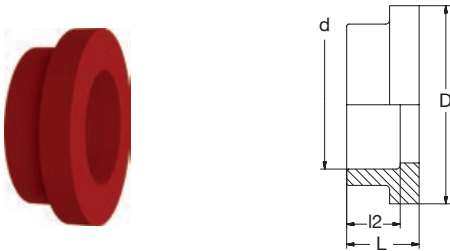

BR CFR Bundbuchse rot

BR CFR Flange adaptor socket red

Art Nr	d	D	L	l2	KG	VE1	VE2
Art No	[mm]		[mm]			PU1	PU2
6331 09F0 2F	40	62,4	25,2	20,3	0,025	-	200
6331 10F0 2F	50	88,0	31,7	22,4	0,063	-	80
6331 11F0 2F	63	97,0	35,5	26,2	0,086	-	50
6331 12F0 2F	75	116,2	38,4	30,0	0,121	-	40
6331 13F0 2F	90	134,8	43,9	34,2	0,200	-	90
6331 14F0 2F	110	159,6	49,5	40,0	0,304	-	52
6331 15F0 2F	125	184,4	52,0	44,0	0,493	-	36

6.02.08 Einschweißsättel • Weld-in-saddles

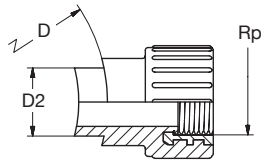

BR CFR-Ms Ü-Einschweißsattel IG-zyl rot

BR CFR-Brass Trans-weld-in-saddle female-thread-cyl red

Art Nr	D x Rp	D2	KG	VE1	VE2
Art No	[mm x inch]	[mm]		PU1	PU2
6M71 0943 2F	40 x 1/2	25	0,053	1	150
6M71 0945 2F	40 x 3/4	25	0,069	1	150
6M71 1043 2F	50 x 1/2	25	0,053	1	150
6M71 1045 2F	50 x 3/4	25	0,069	1	150
6M71 1143 2F	63 x 1/2	25	0,053	1	150
6M71 1145 2F	63 x 3/4	25	0,069	1	150
6M71 1243 2F	75 x 1/2	25	0,053	1	150
6M71 1245 2F	75 x 3/4	25	0,069	1	150
6M71 1246 2F	75 x 1	32	0,053	1	150
6M71 1343 2F	90 x 1/2	25	0,069	1	150
6M71 1345 2F	90 x 3/4	25	0,053	1	150
6M71 1346 2F	90 x 1	32	0,069	1	150
6M71 1443 2F	110 x 1/2	25	0,053	1	150
6M71 1445 2F	110 x 3/4	25	0,069	1	150
6M71 1446 2F	110 x 1	32	0,176	1	150
6M71 1543 2F	125 x 1/2	25	0,176	1	150
6M71 1545 2F	125 x 3/4	25	0,176	1	150
6M71 1546 2F	125 x 1	32	0,176	1	150

6.02.09 Kugelhähne • Ball valves

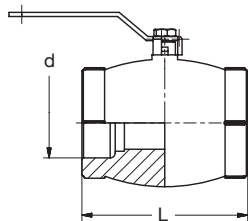

BR CFR Kugelhahn rot

BR CFR Ball valve red

Art Nr	d	L	KG	VE1	VE2
Art No	[mm]	[mm]		PU1	PU2
6911 0600 2F	20	71,2	0,100	10	100
6911 0700 2F	25	83,0	0,130	10	50
6911 0800 2F	32	88,0	0,213	5	40
6911 0900 2F	40	111,0	0,442	2	20
6911 1000 2F	50	119,0	0,483	2	20
6911 1100 2F	63	139,0	0,780	1	10
6911 1200 2F	75	160,0	1,10	1	5

Vorfertigung von Sonderbauteilen

Wir bieten für die Werkstoffe Polyethylen und Polypropylen die Fertigung individueller Formteile und Verteiler / Sammler nach Ihren Wünschen an. Zeit ist Geld und enge Zeitvorgaben spielen heute in der Baubranche eine immer bedeutendere Rolle. Vorgefertigte Bauteile sind deswegen sowohl für Architekten und Planer, sowie für den Installateur von großem Nutzen.

Ausgebildete Schweißfachkräfte erstellen in unserem Werk fachgerecht Teile nach Ihren Vorgaben.

Um Missverständnisse zu vermeiden ist es ratsam Planungsdaten, eine 3D Zeichnung bzw. eine bemaßte Skizze zur Angebotserstellung einzureichen. Unser kompetentes Team erstellt Ihnen daraufhin ein Angebot inkl. Zeichnung und Materialauszug.

Vorteile:

- Schnelle Montagezeiten
- Gewichtsersparnis durch Einsatz moderner Kunststoffe
- Qualität durch industrielle Vorfertigung „Made in Germany“

Wir haben darüber hinaus bereits einige Sonderformteile im Programm die Sie bei uns ohne weitere Vorgaben direkt bestellen können.

Prefabrication of special items

We offer the manufacturing of individual items and manifolds / collectors for the materials Polyethylene and Polypropylene according to your requirements. Time is money and tight deadlines play an increasingly important role in the construction industry today.

Prefabricated components are therefore a great benefit for architects and planners, as well as for the installer.

Trained welding specialists professionally create items according to your specifications in our factory.

In order to avoid misunderstandings, it is advisable to submit planning data, a 3D drawing or a dimensioned sketch for the preparation of the offer. Our capable team will prepare you an offer including a drawing and material extract.

Benefits:

- Fast assembly times
- Weight saving through the use of state-of-the-art-materials
- Quality through industrial prefabrication „Made in Germany“

In addition, we already have some special items in our program that you can order directly from us without any further requirements.

Vorschweißbunde in Sonderlänge

Auf Basis unserer kurzen Vorschweißbunde SDR11 und 17 bieten wir Ihnen dieses Formteil in Sonderlängen durch Anschweißen von Rohren nach Ihren Maßvorgaben an. Die Schweißwülste sind auf der Innen- und Außenseite entfernt. Die gewünschte Gesamtlänge des Bauteils wird in mm-Angaben als 4 stellige Zahl der Bauteil-Artikelnummer angehängt.

Auch für Sonderflanschverbindungen bieten wir dies nach dem gleichen Schema an.

Flange adaptors spigot in special lengths

On the basis of our short flange adaptors spigot SDR11 and 17, we offer you this item in special lengths by welding pipes according to your dimensional specifications. The welding beads are removed on the inside and outside. The desired overall length of the component is appended in mm as a 4-digit number to the component article number.

We also offer this for special flange connections according to the same scheme.



VB SDR11 = 2335 __ F0 15 xxxx
VB SDR17 = 2336 __ F0 15 xxxx

xxxx = L [mm]



SFV SDR11 = 9115 __ E_ 15 xxxx
SFV SDR17 = 9116 __ E_ 15 xxxx

xxxx = L [mm]

Flanschverbindungsteile

Vorgefertigte Formteile für Flanschverbindungen bieten wir z.B. in Form von T-Stücken in verschiedenen Varianten mit angeschweißten Vorschweißbunden inkl. Losflansch an.

Die nachfolgenden Bilder zeigen einige Beispiele die wir bereits für Kunden umgesetzt haben.

Flange connection items

We offer prefabricated items for flange connections e.g. in the form of tee's in different versions with welded flange adaptors including loose flange.

The following pictures show some examples that we have already built for customers.



Verteiler / Sammler

Zur Erstellung von Verteilern und Sammlern benötigen wir im Vorfeld so viele Informationen wie möglich. Wünschenswert ist eine CAD-Zeichnung, bzw. wenn nicht möglich, eine bemaßte Skizze.

Wir prüfen dann zunächst die Machbarkeit sowie die Vollständigkeit und Plausibilität der Vorgaben. Hydraulische Schemen ersetzen keine Detailplanung und sind nur zur Prüfung der Machbarkeit geeignet. Sofern die Detailplanung der Verteiler / Sammler auf anderen Werkstoffen oder fremden Produktportfolios beruht, passen wir die Vorgaben entsprechend den Möglichkeiten des Materials und den verfügbaren Formteilen an.

Erst nach abgeschlossener Prüfung erstellen wir ein Angebot auf Basis Ihrer Vorgaben. Sie bekommen im Anschluss eine detaillierte CAD-Zeichnung mit Massenauszug zur Prüfung und Freigabe.

Auf Wunsch erhalten Sie zu jedem Sonderbauteil unsere CAD-Daten zur Übernahme in Ihre Planungsdaten.

Bei allen Fragen und Problemen stehen wir Ihnen gerne unterstützend und beratend zur Verfügung.

Manifolds / collectors

For the manufacturing of manifolds and collectors we need as much information as possible in advance. A CAD drawing or, if not possible, a dimensioned sketch is desirable.

First and foremost we check the feasibility as well as the completeness and plausibility of the specifications. Hydraulic schemes do not replace detailed planning and are only suitable for verifying a feasibility. If the detailed planning of the manifolds / collectors is based on other materials or third-party product portfolios, we adapt the specifications according to the possibilities of the material and the available items.

After the check has been completed, we prepare an offer based on your specifications.

You will then receive a detailed CAD drawing with a mass extract for checking and approval.

Upon request, you can receive our CAD data for each special item to be included in your planning data.

We will be happy to support and advise you on all questions and problems.

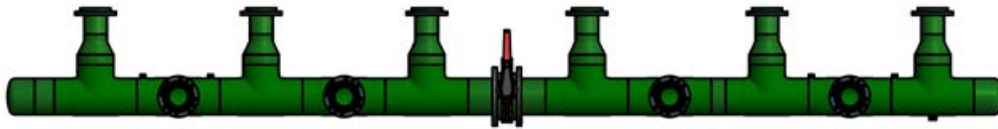

Fertigung

Unser hochqualifiziertes Team fertigt die Bauteile in sauberer Umgebung an. Baustellen mit schmutzigen und staubigen Umgebungen oder kalte Einbaubedingungen nehmen hier keinen Einfluss auf die Produktqualität.

Vorfertigung bedeutet Zeitersparnis.

Manufacturing

Our highly qualified team produces the items in a clean environment. Construction sites with dirty and dusty environments or cold installation conditions have no influence on the product quality here.

Prefabrication means saving time.



Hinweis

Bitte berücksichtigen Sie bei allen Sonderbauteilen systembedingte Toleranzen die bei der Erstellung von Kunststoff-Schweißverbindungen entstehen können. Siehe auch Hinweise im jeweiligen Produktkapitel des Kataloges.

Note



For all special components, please take into account system-related tolerances that may appear when creating plastic welded connections. See also notes in the respective product chapter of the catalogue.

Z.01 Flansche • Flanges	ZUB 2	Z.04 Montagematerial • Mounting material	ZUB 14
<hr/>			
Z.01.01 Losflansche DIN-EN Flanges DIN-EN	ZUB 2	Z.05 Werkzeuge • Installations tools	ZUB 15
<hr/>			
 		Z.05.01 Schneiden Cutting	ZUB 15
<hr/>			
Z.01.02 Losflansche ANSI Flanges ANSI	ZUB 5	Z.05.02 Reinigen Cleaning	ZUB 19
<hr/>			
 		Z.05.03 Kleben Bonding	ZUB 19
<hr/>			
Z.01.03 Sonder-Flanschverbindung Special Flange connection	ZUB 7	Z.05.04 Heizelement-Muffen-Schweißen Socket welding	ZUB 20
<hr/>			
		Z.05.05 Heizelement-Stumpf-Schweißen Butt welding	ZUB 23
<hr/>			
Z.02 Dichtungen • Gaskets	ZUB 9	Z.05.06 Heizwendel-Muffen-Schweißen Electrofusion-socket welding	ZUB 30
<hr/>			
Z.02.01 Runddichtringe O-Ring-Gaskets	ZUB 9	Z.05.07 Einschweißsättel Weld-in-saddles	ZUB 35
<hr/>			
		Z.05.08 Schälwerkzeuge Stabitec Peeling tools Stabitec	ZUB 37
<hr/>			
Z.02.02 Flachdichtringe Flat-Gaskets	ZUB 10	Z.05.09 Reparatursets Repair sets	ZUB 37
<hr/>			
		Z.05.10 Verschiedenes Miscellaneous	ZUB 38
<hr/>			
Z.02.03 Flachdichtringe mit Stahleinlage Flat-Gaskets with Steel-inlay	ZUB 11	Z.06 Armaturen • Valves	ZUB 39
<hr/>			
			
<hr/>			
Z.03 Clipse und Schellen • Clips and clamps	ZUB 13		
<hr/>			
  			





Z.01 Flansche • Flanges

Bei den Flanschverbindungen finden sich Symbole, die erkennen lassen, welche Rohr-Verbindungs-Formteile mit den Flanschringen benutzt werden können.

-  Bundbuchse
-  Vorschweißbund
-  Bundbuchse + Vorschweißbund

„PN gebohrt“ bedeutet, dass das Lochbild für die Schrauben der angegebenen Druckstufe entspricht.

For the flange connections, there are symbols which indicate which pipe connection fitting with the flange rings can be used.

-  Flange adaptor socket
-  Flange adaptor spigot
-  Flange adaptor socket + spigot

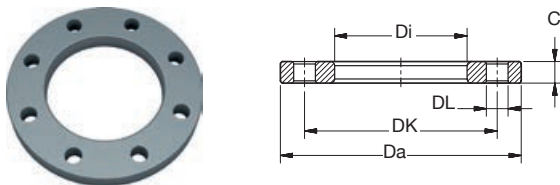

„PN drilled“ means that the hole pattern for the screws corresponds to the indicated pressure step.

Z.01.01 Losflansche entsprechend Flanges according to DIN-EN 1092-1



BR PVC-U Losflansch DIN-EN grau

BR PVC-U Flange loose DIN-EN grey

Art Nr Art No	d [mm]	BB 	VB 	PN [bar] gebohrt drilled	DN	Da	Di	C	nL	DL	DK	 kg	VE1 PU1
9131 05E1 32	16	•	•	10/16	10	90	23	12	4	14	60	0,06	5
9131 06E1 32	20	•	•	10/16	15	95	28	12	4	14	65	0,07	5
9131 07E1 32	25	•	•	10/16	20	105	34	14	4	14	75	0,09	5
9131 08E1 12	32	•	•	10/16	25	115	42	15	4	14	85	0,14	5
9131 09E1 12	40	•	•	10/16	32	140	51	15	4	18	100	0,20	5
9131 10E1 12	50	•	•	10/16	40	150	62	16	4	18	110	0,24	5
9131 11E1 12	63	•	•	10/16	50	165	78	18	4	18	125	0,32	5
9131 12E1 12	75	•	•	10/16	65	185	92	19	4	18	145	0,40	5
9132 13E1 12	90	•	•	10/16	80	200	110	20	8	18	160	0,48	5
9132 14E1 12	110	•	•	10/16	100	220	133	22	8	18	180	0,60	5
9132 16E1 12	140	•	•	10/16	125	250	167	26	8	18	210	0,74	5
9132 17E1 12	160	•	•	10/16	150	285	190	28	8	22	240	1,05	5
9132 20E2 32	225	•	•	10	200	340	250	30	8	22	295	1,56	5
9132 21E2 32	250	•	•	10	250	370	277	36	8	22	325	1,80	1
9132 22E2 32	280	•	•	10	250	399	307	32	12	22	350	1,84	1
9132 23E2 32	315	•	•	10	300	450	345	34	12	22	400	2,45	1

 BB = Bundbuchse • Flange adaptor socket

 VB = Vorschweißbund • Flange adaptor spigot

Z.01.01 Losflansche entsprechend Flanges according to DIN-EN 1092-1

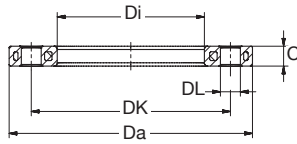

BR PP-St Losflansch DIN-EN schwarz

BR PP-St Flange loose DIN-EN black

Art Nr Art No	d [mm]	BB 	VB 	PN [bar] gebohrt drilled	DN	Da	Di	C	nL	DL	DK	KG 	VE1 PU1
9141 06E1 35	20	•	•	10/16	15	95	28	14	4	12	65	0,24	1
9141 07E1 15	25	•	•	10/16	20	105	34	14	4	14	75	0,33	1
9141 08E1 15	32	•	•	10/16	25	115	42	14	4	14	85	0,46	1
9141 09E1 15	40	•	•	10/16	32	140	51	16	4	18	100	0,67	1
9141 10E1 15	50	•	•	10/16	40	150	62	18	4	18	110	0,78	1
9141 11E1 15	63	•	•	10/16	50	165	78	18	4	18	125	0,88	1
9141 12E1 15	75	•	•	10/16	65	185	92	18	4	18	145	1,14	1
9142 13E1 15	90	•	•	10/16	80	200	110	18	8	18	160	1,10	1
9142 14E1 15	110	•	•	10/16	100	220	133	18	8	18	180	1,17	1
9142 15E1 15	125	•	•	10/16	100	220	149	18	8	18	180	1,05	1
9142 16E1 15	140	•	•	10/16	125	250	167	18	8	24	210	1,80	1
9142 17E1 15	160	•	•	10/16	150	285	190	22	8	24	240	2,67	1
9142 20E2 15	225	•	•	10	200	340	250	24	8	24	295	2,98	1
9143 13E1 15	90	•	•	10/16	80	200	108	18	8	18	160	1,12	1
9143 14E1 15	110	•	•	10/16	100	220	128	18	8	18	180	1,19	1
9143 15E1 15	125	•	•	10/16	100	220	135	18	8	18	180	1,21	1
9143 16E1 15	140	•	•	10/16	125	250	158	24	8	18	210	1,86	1
9143 17E1 15	160	•	•	10/16	150	285	178	24	8	22	240	2,77	1
9143 18E1 15	180	•	•	10/16	150	285	188	24	8	22	240	2,70	1
9143 19E2 15	200	•	•	10	200	340	235	24	8	22	295	3,77	1
9143 20E2 15	225	•	•	10	200	340	238	24	8	22	295	3,74	1
9143 21E2 15	250	•	•	10	250	406	288	31	12	22	350	6,00	1
9143 22E2 15	280	•	•	10	250	406	294	34	12	22	350	5,50	1
9143 23E2 15	315	•	•	10	300	460	338	34	12	22	400	9,20	1
9143 24E2 15	355	•	•	10	350	520	376	39	16	22	460	14,8	1
9143 25E2 15	400	•	•	10	400	580	430	43	16	26	515	16,6	1
9143 26E2 35	450	•	•	10	500	675	517	54	20	26	620	24,5	1
9143 27E2 35	500	•	•	10	500	675	533	54	20	26	620	24,4	1
9143 28E2 35	560	•	•	10	600	796	618	64	20	30	725	33,5	1
9143 29E2 35	630	•	•	10	600	800	645	58	20	30	725	32,4	1
9143 19E3 35	200	•	•	16	200	340	235	26	12	22	295	3,20	1
9143 20E3 35	225	•	•	16	200	340	238	26	12	22	295	2,80	1
9143 21E3 35	250	•	•	16	250	404	280	32	12	22	355	6,90	1
9143 22E3 35	280	•	•	16	250	404	290	32	12	22	355	4,80	1
9143 23E3 35	315	•	•	16	300	474	340	34	12	22	410	8,10	1
9143 24E3 35	355	•	•	16	315	530	377	50	16	26	474	17,8	1
9143 25E3 35	400	•	•	16	355	590	430	54	16	30	533	21,8	1

BB = Bundbuchse • Flange adaptor socket

VB = Vorschweißbund • Flange adaptor spigot



Z.01.01 Losflansche entsprechend Flanges according to DIN-EN 1092-1

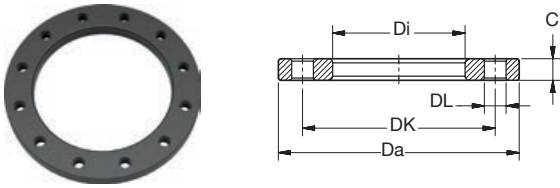

BR St Losflansch beschichtet VB DIN-EN schwarz
BR St Flange loose coated for flange adaptor spigot DIN-EN black

Art Nr Art No	d [mm]	PN [bar] gebohrt drilled	DN	Da	Di	C	nL	DL	DK	KG	VE1 PU1
			[mm]								
9113 30E2 05	710	10	700	895	740	40	24	30	840	42,0	1
9113 31E2 05	800	10	800	1015	843	44	24	33	950	48,0	1
9113 32E2 05	900	10	900	1115	947	44	28	33	1050	59,0	1
9113 33E2 05	1000	10	1000	1230	1050	44	28	36	1160	70,0	1

VB = Vorschweißbund • Flange adaptor spigot

Beschichtung • Coating: Plascoat PPA571
Gebohrt nach • Drilled to: EN1092-1

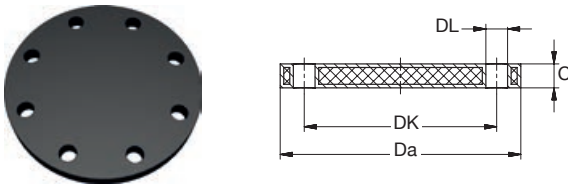

BR PP-St Blindflansch DIN-EN schwarz
BR PP-St Flange blind DIN-EN black

Art Nr Art No	d [mm]	PN [bar] gebohrt drilled	DN	Da	C	nL	DL	DK	KG	VE1 PU1
			[mm]							
9144 07E1 35	25	10/16	20	105	12	4	14	75	0,38	1
9144 08E1 35	32	10/16	25	115	16	4	14	85	0,52	1
9144 09E1 35	40	10/16	32	140	16	4	18	100	0,80	1
9144 10E1 35	50	10/16	40	150	16	4	18	110	0,92	1
9144 11E1 35	63	10/16	50	165	16	4	18	125	1,16	1
9144 12E1 35	75	10/16	65	185	18	4	18	145	1,60	1
9144 13E1 35	90	10/16	80	200	20	8	18	160	2,26	1
9144 14E1 35	110/125	10/16	100	220	20	8	18	180	2,33	1
9144 16E1 35	140	10/16	125	250	24	8	18	210	3,88	1
9144 17E1 35	160/180	10/16	150	285	24	8	22	240	5,02	1
9144 19E2 35	200/225	10	200	340	24	8	22	295	7,60	1
9144 21E2 35	250/280	10	250	409	30	12	22	350	15,3	1
9144 23E2 35	315	10	300	463	34	12	22	400	25,7	1
9144 24E2 35	355	10	350	515	42	16	22	460	40,0	1
9144 25E2 35	400	10	400	574	46	16	27	515	50,4	1

Z.01.02 Losflansche ANSI entsprechend Flanges ANSI according B16.5

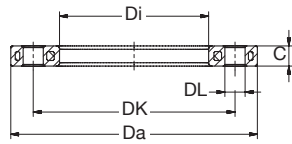

BR PP-St Losflansch ANSI kieselgrau
BR PP-St Flange loose ANSI pebble grey

Art Nr Art No	d [mm]	BB 	VB 	PN [lbs]	DN [Inch]	Da	Di	C	nL	DL	DK		VE1 PU1	VE2 PU2
[mm]														
9141 06A2 38	20	•	•	150	1/2	95	28	12	4	16	60	0,21	1	60
9141 07A2 38	25	•	•	150	3/4	102	34	12	4	16	70	0,24	1	50
9141 08A2 38	32	•	•	150	1	114	42	16	4	16	79	0,37	1	30
9141 09A2 38	40	•	•	150	1 1/4	130	51	16	4	16	89	0,56	1	22
9141 10A2 38	50	•	•	150	1 1/2	133	62	16	4	16	98	0,54	1	21
9141 12A2 38	75	•	•	150	2 1/2	184	92	18	4	20	140	1,07	1	15
9141 13A2 38	90	•	•	150	3	194	111	18	4	20	152	1,03	1	15
9143 14A2 38	110/125	• *	•	150	4	229	133	18	8	20	190	1,55	1	12
9143 17A2 38	160	•	•	150	6	283	178	24	8	22	241	2,32	1	7
9143 19A2 38	200/225	•	•	150	8	345	236	24	8	22	298	3,43	1	5
9143 21A2 38	250	•	•	150	10	412	288	27	12	25	362	6,10	1	28
9143 23A2 38	315	•	•	150	12	487	338	32	12	25	432	13,0	1	20
9143 24A2 38	355	•	•	150	14	540	375	38	12	28,6	476	17,9	1	-
9143 25A2 38	400	•	•	150	16								1	-
9143 27A2 38	500	•	•	150	20								1	-

* nur d110 • only d110

BB = Bundbuchse • Flange adaptor socket
 VB = Vorschweißbund • Flange adaptor spigot

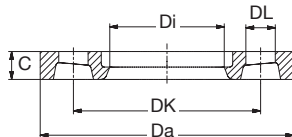

BR PP-GGG Losflansch ANSI Deltaflex schwarz
BR PP-GGG Flange loose ANSI Deltaflex black

Art Nr Art No	d [mm]	BB 	VB 	PN [lbs]	DN [Inch]	Da	Di	C	nL	DL	DK		VE1 PU1
[mm]													
9151 11A2 25	63	•	•	150	2	164	78	18	4	19	121	0,80	1
9152 14A2 25	110	•	•	150	4							1,80	1
9153 13A2 25	90	•	•	150	3	196	108	19	4	19	153	1,00	1
9153 14A2 25	110	•	•	150	4	237	128	25	8	19	191	1,80	1
9153 17A2 25	160	•	•	150	6	297	178	30	8	22	242	3,30	1
9153 18A2 25	180	•	•	150	6	297	188	30	8	22	241,5	3,20	1
9153 19A2 25	200/225	•	•	150	8	354	238	34	8	22	299	5,10	1
9153 21A2 25	250	•	•	150	10	425	288	38	12	26	362	6,90	1
9153 23A2 25	315	•	•	150	12	497	338	51	12	26	432	12,8	1

BB = Bundbuchse • Flange adaptor socket
 VB = Vorschweißbund • Flange adaptor spigot



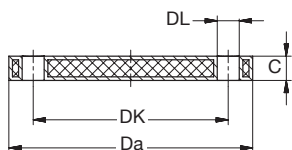

BR PP-St Blindflansch ANSI kieselgrau

BR PP-St Flange blind ANSI pebble grey

Art Nr	d	PN	DN	Da	C	nL	DL	DK	KG	VE1	VE2
Art No	[mm]	[lbs]	[Inch]							PU1	PU2
9144 06A2 38	20	150	1/2	95	12	4	16	60	0,26	1	60
9144 07A2 38	25	150	3/4	102	12	4	16	70	0,34	1	40
9144 08A2 38	32	150	1	114	16	4	16	79	0,51	1	30
9144 09A2 38	40	150	1 1/4	130	16	4	16	89	0,74	1	20
9144 10A2 38	50	150	1 1/2	133	16	4	16	98	0,86	1	15
9144 11A2 38	63	150	2	162	18	4	20	121	1,22	1	14
9144 12A2 38	75	150	2 1/2	181	18	4	20	140	1,54	1	15
9144 13A2 38	90	150	3	194	18	4	20	152	1,84	1	10
9144 14A2 38	110/125	150	4	229	18	8	20	190	2,88	1	10
9144 17A2 38	160	150	6	283	24	8	22	241	5,10	1	5
9144 19A2 38	200/225	150	8	345	24	8	22	298	7,92	1	5
9144 21A2 38	250/280	150	10	412	27	12	25	362	15,2	1	-
9144 23A2 38	315	150	12	487	34	12	25	432	28,8	1	-

PE100 Sonder-Flanschverbindung lang

PE100 Special flange connection long

Ausführung

Langes Schweißende; für Heizelement-Stumpf-Schweißen und E-Muffen-Schweißen geeignet. Gebohrt nach DIN EN 1092-1. Standardmäßig mit EPDM-Runddichtring, SDR11/17 und PN10/16.

Mit kunststoffbeschichtetem Sphäroguss- oder Stahlflansch. Ausführung abhängig von der SDR-Klasse und DN/D-Kombination.

Optional

Flansche aus Edelstahl; Flansche aus verzinktem Stahl; flachdichtend ohne Nut und ohne O-Ring; PN25 gebohrt; mit Langloch.

Für Gasleitungen mit glatter Dichtfläche oder NBR-Dichtung lieferbar.

Anwendung

Direkter Anschluss an Armaturen ohne Reduzierung der Nennweite (DN).

Besonderheiten

- Besonders stabil
- Strömungsgünstig
- Reduzierter Totraum
- Integrierte O-Ring-Dichtung
- Klappe der Armatur ist frei beweglich

Type

Long welding end; for the use of butt-welding electrofusion socket-welding. Drilled according to DIN EN 1092-1. By default inclusive EPDM-O-Ring, SDR11/17 and PN10/16.

With ductile cast iron or steel backing rings, plastic coated. Type depending on the SDR-Class and on the combination of DN/D.

Optional

Stainless steel backing rings; hot dipped galvanized backing rings; flat sealing surface without flute or O-Ring; PN25 drilled; with slotted holes.

Available for gas pipes with flat surface or NBR-Gaskets.

Application

For direct connection to valves according to nominal diameter (DN).

Special features

- Extra stable
- Streamlined
- Reduced dead space
- Integrated O-ring seal
- Disc of the valve is free to move

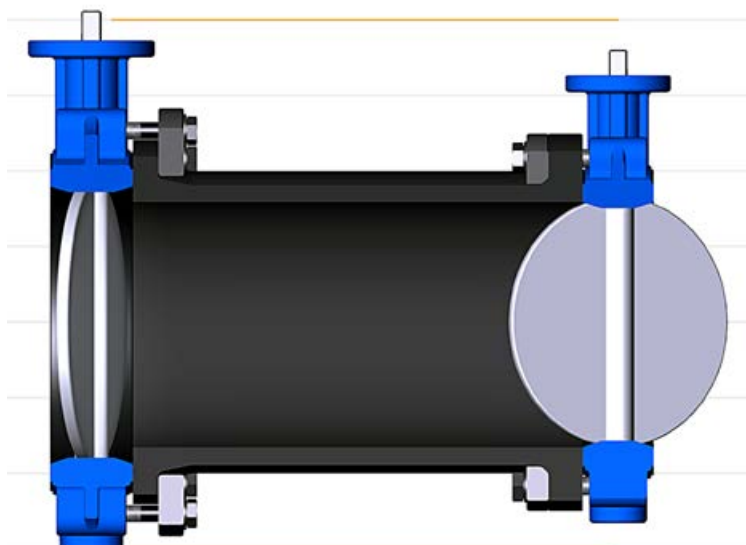
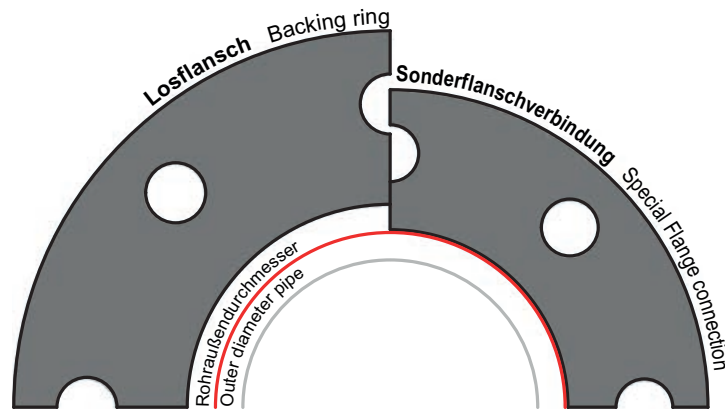

Z.01.03 Sonder-Flanschverbindung lang • Special flange connection long

BR PE100 Sonder-Flansch-Verbindung lang **SDR11** schwarz

BR PE100 Special flange connection long **SDR11** black

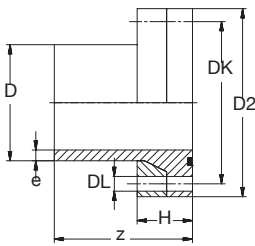

Art Nr	D	PN	DN	e	D2	Z	H	nL	DL	DK			VE1	
Art No	[mm]	gebohrt drilled	[mm]											PU1
9115 13E1 39	90	10/16	65	8,2	185	150	40	4	18	145	M16	3,50	1	
9115 14E1 39	110	10/16	80	10,0	200	155	40	8	18	160	M16	4,50	1	
9115 16E1 39	140	10/16	100	12,7	220	180	45	8	18	180	M16	5,00	1	
9115 17E1 39	160	10/16	125	14,6	250	190	45	8	18	210	M16	6,50	1	
9115 18E1 39	180	10/16	125	16,4	250	195	45	8	18	210	M16	6,50	1	
9115 19E1 39	200	10/16	150	18,2	285	205	50	8	22	240	M20	8,00	1	
9115 21E3 39	250	16	200	22,8	340	245	65	12	22	295	M20	13,0	1	
9115 23E3 39	315	16	250	28,7	405	275	65	12	26	355	M24	20,0	1	
9115 24E3 39	355	16	300	32,3	460	275	65	12	26	410	M24	26,0	1	
9115 25E3 39	400	16	350	36,4	520	330	95	16	26	470	M24	39,0	1	
9115 26E3 39	450	16	400	41,1	580	340	105	16	30	525	M27	52,5	1	
9115 27E3 39	500	16	500	45,4	565	600	92	16	30	525	M27	63,5	1	
9115 28E3 39	560	16	500	51,0	715	395	105	20	33	650	M30	83,0	1	
9115 29E3 39	630	16	500	57,2	715	255	105	20	33	650	M30	95,5	1	
9115 21E2 39	250	10	200	22,8	340	240	60	8	22	295	M20	12,0	1	
9115 23E2 39	315	10	250	28,7	395	270	60	12	22	350	M20	17,0	1	
9115 24E2 39	355	10	300	32,3	445	270	60	12	22	400	M20	22,0	1	
9115 25E2 39	400	10	350	36,4	505	325	90	16	22	460	M20	30,0	1	
9115 26E2 39	450	10	400	41,1	565	335	100	16	26	515	M24	39,0	1	
9115 27E2 39	500	10	400	45,4	565	590	81	16	26	515	M24	50,0	1	
9115 28E2 39	560	10	500	51,0	670	370	100	20	26	620	M24	58,0	1	
9115 29E2 39	630	10	500	57,2	670	255	100	20	26	620	M24	117,0	1	

BR PE100 Sonder-Flansch-Verbindung lang **SDR17** schwarz

BR PE100 Special flange connection long **SDR17** black

Art Nr	D	PN	DN	e	D2	Z	H	nL	DL	DK			VE1	
Art No	[mm]	gebohrt drilled	[mm]											PU1
9116 13E1 39	90	10/16	65	8,2	185	150	40	4	18	145	M16	3,50	1	
9116 14E1 39	110	10/16	80	10,0	200	155	40	8	18	160	M16	4,50	1	
9116 16E1 39	140	10/16	100	12,7	220	180	45	8	18	180	M16	5,00	1	
9116 17E1 39	160	10/16	125	14,6	250	190	45	8	18	210	M16	6,50	1	
9116 18E1 39	180	10/16	125	16,4	250	195	45	8	18	210	M16	6,50	1	
9116 19E1 39	200	10/16	150	18,2	285	205	50	8	22	240	M20	8,00	1	
9116 21E3 39	250	16	200	22,8	268	350	64	12	22	295	M20	13,0	1	
9116 23E3 39	315	16	250	28,7	315	380	72	12	26	355	M24	20,0	1	
9116 24E3 39	355	16	300	32,3	275	360	74	12	26	410	M24	26,0	1	
9116 25E3 39	400	16	350	36,4	380	430	89	16	26	470	M24	39,0	1	
9116 26E3 39	450	16	400	41,1	560	430	92	16	30	525	M27	52,5	1	
9116 27E3 39	500	16	500	45,4	565	600	92	16	30	525	M27	63,5	1	
9116 28E3 39	560	16	500	51,0	400	440	98	20	33	650	M30	83,0	1	
9116 29E3 39	630	16	500	57,2	610	620	98	20	33	650	M30	95,5	1	
9116 21E2 39	250	10	200	22,8	340	240	60	8	22	295	M20	12,0	1	
9116 23E2 39	315	10	250	28,7	395	270	60	12	22	350	M20	17,0	1	
9116 24E2 39	355	10	300	32,3	445	270	60	12	22	400	M20	22,0	1	
9116 25E2 39	400	10	350	36,4	505	325	90	16	22	460	M20	30,0	1	
9116 26E2 39	450	10	400	41,1	565	335	100	16	26	515	M24	39,0	1	
9116 27E2 39	500	10	400	45,4	565	570	81	16	26	515	M24	50,0	1	
9116 28E2 39	560	10	500	51,0	670	370	100	20	26	620	M24	58,0	1	
9116 29E2 39	630	10	500	57,2	670	255	100	20	26	620	M24	117,0	1	

Z.02.01 Runddichtringe • O-Ring-gaskets

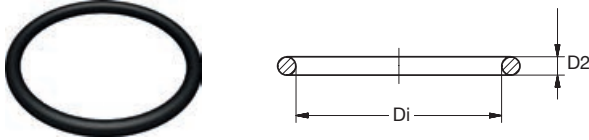

Runddichtring-EPDM für Bundbuchsen mit O-Ring-Kammer schwarz
 O-Ring gasket-EPDM for flange adaptor socket with O-Ring chamber black

Art Nr	d	Di	D2	KG	VE1
Art No	[mm]	[mm]			PU1
9201 05R1 35	16	18,6	3,53	0,001	1
9201 06R1 35	20	23,3	3,53	0,001	1
9201 07R1 35	25	28,1	3,53	0,002	1
9201 08R1 35	32	36,0	3,53	0,003	1
9201 09R1 35	40	43,9	3,53	0,004	1
9201 10R1 35	50	53,4	5,33	0,01	1
9201 11R1 35	63	69,3	5,33	0,01	1
9201 12R1 35	75	81,9	5,33	0,01	1
9201 13R1 35	90	101,0	5,33	0,01	1
9201 14R1 35	110	120,0	6,99	0,03	1
9201 16R1 35	140	151,7	6,99	0,06	1
9201 17R1 35	160	177,1	6,99	0,07	1
9201 20R1 35	225	240,7	6,99	0,08	1

Für Wasser, Shorehärte 70 ±5
 For water, shore hardness 70 ±5

Runddichtring-FKM für Bundbuchsen mit O-Ring-Kammer schwarz
 O-Ring gasket-FKM for flange adaptor socket with O-Ring chamber black

Art Nr	d	Di	D2	KG	VE1
Art No	[mm]	[mm]			PU1
9201 05R3 35	16	18,6	3,53	0,001	1
9201 06R3 35	20	23,3	3,53	0,001	1
9201 07R3 35	25	28,1	3,53	0,002	1
9201 08R3 35	32	36,0	3,53	0,003	1
9201 09R3 35	40	43,9	3,53	0,004	1
9201 10R3 35	50	53,4	5,33	0,01	1
9201 11R3 35	63	69,3	5,33	0,01	1
9201 12R3 35	75	81,9	5,33	0,01	1
9201 13R3 35	90	101,0	5,33	0,01	1
9201 14R3 35	110	120,0	6,99	0,03	1
9201 16R3 35	140	151,7	6,99	0,06	1
9201 17R3 35	160	177,1	6,99	0,07	1
9201 20R3 35	225	240,7	6,99	0,08	1

Für Wasser, Shorehärte 70 ±5
 For water, shore hardness 70 ±5

Runddichtring-EPDM für Verschraubungen schwarz
 O-Ring gasket-EPDM for unions black

Art Nr	G	Di	D2	KG	VE1
Art No	[Inch]	[mm]			PU1
9205 44R1 35	5/8	12,37	2,62	0,001	1
9205 45R1 35	3/4	15,55	2,62	0,001	1
9205 46R1 35	1	20,22	3,53	0,001	1
9201 07R1 35	1 1/4	28,10	3,53	0,002	1
9205 48R1 35	1 1/2	32,92	3,53	0,002	1
9205 50R1 35	2	40,64	5,33	0,003	1
9205 51R1 35	2 1/4	47,00	5,33	0,004	1
9205 54R1 35	2 3/4	59,70	5,33	0,005	1
9205 56R1 35	3 1/2	75,56	5,33	0,01	1
9205 57R1 35	4	91,45	5,33	0,01	1
9205 58R1 35	5	113,66	5,33	0,01	1

Für Wasser, Shorehärte 70 ±5
 For water, shore hardness 70 ±5

Runddichtring-FKM für Verschraubungen schwarz
 O-Ring gasket-FKM for unions black

Art Nr	G	Di	D2	KG	VE1
Art No	[Inch]	[mm]			PU1
9205 44R3 35	5/8	12,37	2,62	0,001	1
9205 45R3 35	3/4	15,55	2,62	0,001	1
9205 46R3 35	1	20,22	3,53	0,001	1
9201 07R3 35	1 1/4	28,10	3,53	0,002	1
9205 48R3 35	1 1/2	32,92	3,53	0,002	1
9205 50R3 35	2	40,64	5,33	0,003	1
9205 51R3 35	2 1/4	47,00	5,33	0,004	1
9205 54R3 35	2 3/4	59,70	5,33	0,005	1
9205 56R3 35	3 1/2	75,56	5,33	0,01	1
9205 57R3 35	4	91,45	5,33	0,01	1
9205 58R3 35	5	113,66	5,33	0,01	1

Für Wasser, Shorehärte 70 ±5
 For water, shore hardness 70 ±5

Z.02.02 Flachdichtringe • Flat-gaskets

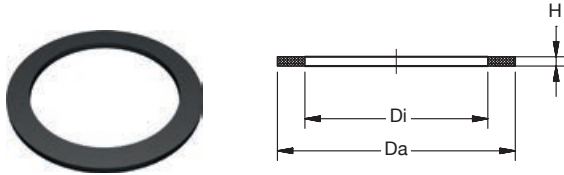

Flachdichtring EPDM für Bundbuchsen schwarz
 Flat gasket ring EPDM for flange adaptor socket black

Art Nr Art No	d [mm]	Da	Di	H	KG	VE1 PU1
9201 05F1 35	16	27	16	2	0,001	1
9201 06F1 35	20	32	20	2	0,001	1
9201 07F1 35	25	39	25	2	0,002	1
9201 08F1 35	32	48	32	2	0,003	1
9201 09F1 35	40	59	40	3	0,004	1
9201 10F1 35	50	71	50	3	0,01	1
9201 11F1 35	63	88	63	3	0,01	1
9201 12F1 35	75	104	75	3	0,01	1
9201 13F1 35	90	123	90	3	0,02	1
9201 14F1 35	110	148	110	4	0,03	1
9201 16F1 35	140	186	140	4	0,05	1
9201 17F1 35	160	211	160	4	0,07	1
9201 20F1 35	225	272	225	4	0,15	1

Für Wasser, Shorehärte 70 ±5
 For water, shore hardness 70 ±5

Flachdichtring-EPDM für Verschraubungen schwarz
 Flat gasket ring EPDM for unions black

Art Nr Art No	G [Inch]	Da	Di	H	KG	VE1 PU1
9205 45F1 35	3/4	24	17	3	0,001	1
9205 46F1 35	1	30	21	3	0,002	1
9205 47F1 35	1 1/4	38	27	3	0,004	1
9205 48F1 35	1 1/2	44	32	3	0,004	1
9205 49F1 35	1 3/4	50	40	3	0,01	1
9205 50F1 35	2	55	42	3	0,01	1
9205 51F1 35	2 1/4	62	46	3	0,01	1
9205 52F1 35	2 3/8	66	52	3	0,01	1
9205 54F1 35	2 3/4 *	78	60	3	0,01	1
9205 84F1 35	2 3/4 **	78	63	3	0,01	1
9205 56F1 35	3 1/2	97	75	3	0,01	1
9205 57F1 35	4	110	88	3	0,02	1
9205 58F1 35	5	135	110	3	0,02	1

* PVC-U/PE100
 ** PP

Für Wasser, Shorehärte 70 ±5
 For water, shore hardness 70 ±5

Z.02.03 Flachdichtringe mit Stahleinlage • Flat-Gaskets with steel-inlay

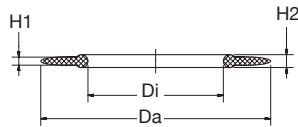

Flachdichtring-EPDM mit Stahleinlage für Bundbuchsen gerillt schwarz

Gasket ring flat EPDM with steel-inlay for flange adaptor socket grooved black

Art Nr	d	Da	Di	H1/H2	KG	VE1
Art No	[mm]		[mm]			PU1
9202 05F1 35	16	46	16	3/4	0,01	1
9202 06F1 35	20	51	20	3/4	0,01	1
9202 07F1 35	25	61	25	3/4	0,01	1
9202 08F1 35	32	71	32	3/4	0,02	1
9202 09F1 35	40	82	40	3/4	0,02	1
9202 10F1 35	50	92	50	3/4	0,02	1
9202 11F1 35	63	107	63	4/5	0,04	1
9202 12F1 35	75	127	75	4/5	0,05	1
9202 13F1 35	90	142	90	4/5	0,06	1
9202 14F1 35	110	162	110	5/6	0,09	1
9202 15F1 35	125	162	105	5/6	0,12	1
9202 16F1 35	140	192	140	5/6	0,11	1
9202 17F1 35	160	218	160	6/8	0,15	1
9202 19F1 35	200	273	200	6/8	0,26	1
9202 20F1 35	225	273	225	6/8	0,18	1
9202 21F1 35	250	328	250	6/8	0,42	1
9202 22F1 35	280	328	280	6/8	0,21	1
9202 23F1 35	315	378	315	6/8	0,34	1

Flachdichtring-NBR mit Stahleinlage für Bundbuchsen gerillt schwarz

Gasket ring flat NBR with steel-inlay for flange adaptor socket grooved black

Art Nr	d	Da	Di	H1/H2	KG	VE1
Art No	[mm]		[mm]			PU1
9202 05F2 35	16	46	16	3/4	0,01	1
9202 06F2 35	20	51	20	3/4	0,01	1
9202 07F2 35	25	61	25	3/4	0,01	1
9202 08F2 35	32	71	32	3/4	0,02	1
9202 09F2 35	40	82	40	3/4	0,02	1
9202 10F2 35	50	92	50	3/4	0,02	1
9202 11F2 35	63	107	63	4/5	0,04	1
9202 12F2 35	75	127	75	4/5	0,05	1
9202 13F2 35	90	142	90	4/5	0,06	1
9202 14F2 35	110	162	110	5/6	0,09	1
9202 15F2 35	125	162	105	5/6	0,12	1
9202 16F2 35	140	192	140	5/6	0,11	1
9202 17F2 35	160	218	160	6/8	0,15	1
9202 19F2 35	200	273	200	6/8	0,26	1
9202 20F2 35	225	273	225	6/8	0,18	1
9202 21F2 35	250	328	250	6/8	0,42	1
9202 22F2 35	280	328	280	6/8	0,21	1
9202 23F2 35	315	378	315	6/8	0,34	1

Z.02.03 Flachdichtringe mit Stahleinlage • Flat-Gaskets with steel-inlay

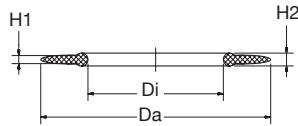

Flachdichtring-EPDM mit Stahleinlage für V-Bunde SDR11 gerillt + flach schwarz
Flat gasket ring-EPDM with steel-inlay for flange adaptor spigot SDR11 grooved + flat black

Flachdichtring-EPDM mit Stahleinlage für V-Bunde SDR17 gerillt + flach schwarz
Flat gasket ring-EPDM with steel-inlay for flange adaptor spigot SDR17 grooved + flat black

Art Nr	D	Da	Di	H1/H2	KG	VE1
Art No	[mm]		[mm]			PU1
9203 07F1 35	25	61	22	3/4	0,01	1
9203 08F1 35	32	71	28	3/4	0,02	1
9203 09F1 35	40	82	34	3/4	0,03	1
9203 10F1 35	50	92	42	3/4	0,03	1
9203 11F1 35	63	107	53	4/5	0,05	1
9203 12F1 35	75	127	63	4/5	0,06	1
9203 13F1 35	90	142	76	4/5	0,07	1
9203 14F1 35	110	162	93	5/6	0,12	1
9203 15F1 35	125	162	105	5/6	0,11	1
9203 16F1 35	140	192	117	5/6	0,15	1
9203 17F1 35	160	218	135	6/8	0,21	1
9203 18F1 35	180	218	151	6/8	0,23	1
9203 19F1 35	200	273	168	6/8	0,41	1
9203 20F1 35	225	273	188	6/8	0,39	1
9203 21F1 35	250	328	208	6/8	0,54	1
9203 22F1 35	280	328	233	6/8	0,50	1
9203 23F1 35	315	378	262	6/8	0,06	1
9203 24F1 35	355	435	294	6/8	0,77	1
9203 25F1 35	400	489	331	6/8	1,0	1
9203 26F1 35	450	594	372	7/10	1,0	1
9203 27F1 35	500	594	413	7/10	1,0	1
9203 28F1 35	560	695	451	7/10	1,0	1
9203 29F1 35	630	695	507	7/10	1,0	1

Art Nr	D	Da	Di	H1/H2	KG	VE1
Art No	[mm]		[mm]			PU1
9204 12F1 35	75	127	69	4/5	0,06	1
9204 13F1 35	90	142	84	4/5	0,07	1
9204 14F1 35	110	162	100	5/6	0,11	1
9204 15F1 35	125	162	114	5/6	0,09	1
9204 16F1 35	140	192	127	5/6	0,12	1
9204 17F1 35	160	218	146	6/8	0,24	1
9204 18F1 35	180	218	164	6/8	0,15	1
9204 19F1 35	200	273	181	6/8	0,39	1
9204 20F1 35	225	273	203	6/8	0,26	1
9204 21F1 35	250	328	226	6/8	0,53	1
9204 22F1 35	280	328	252	6/8	0,41	1
9204 23F1 35	315	378	283	6/8	0,77	1
9204 24F1 35	355	435	319	6/8	0,77	1
9204 25F1 35	400	489	359	6/8	1,00	1
9204 26F1 35	450	594	403	7/10	1,00	1
9204 27F1 35	500	594	447	7/10	1,00	1
9204 28F1 35	560	695	494	7/10	1,00	1
9204 29F1 35	630	695	555	7/10	1,00	1

Flachdichtring-NBR mit Stahleinlage für V-Bunde SDR11 gerillt + flach schwarz
Flat gasket ring-NBR with steel-inlay for flange adaptor spigot SDR11 grooved + flat black

Flachdichtring-NBR mit Stahleinlage für V-Bunde SDR17 gerillt + flach schwarz
Flat gasket ring-NBR with steel-inlay for flange adaptor spigot SDR17 grooved + flat black

Art Nr	D	Da	Di	H1/H2	KG	VE1
Art No	[mm]		[mm]			PU1
9203 07F2 35	25	61	22	3/4	0,01	1
9203 08F2 35	32	71	28	3/4	0,02	1
9203 09F2 35	40	82	34	3/4	0,03	1
9203 10F2 35	50	92	42	3/4	0,03	1
9203 11F2 35	63	107	53	4/5	0,05	1
9203 12F2 35	75	127	63	4/5	0,06	1
9203 13F2 35	90	142	76	4/5	0,07	1
9203 14F2 35	110	162	93	5/6	0,12	1
9203 15F2 35	125	162	105	5/6	0,11	1
9203 16F2 35	140	192	117	5/6	0,15	1
9203 17F2 35	160	218	135	6/8	0,21	1
9203 18F2 35	180	218	151	6/8	0,23	1
9203 19F2 35	200	273	168	6/8	0,41	1
9203 20F2 35	225	273	188	6/8	0,39	1
9203 21F2 35	250	328	208	6/8	0,54	1
9203 22F2 35	280	328	233	6/8	0,50	1
9203 23F2 35	315	378	262	6/8	0,06	1
9203 24F2 35	355	435	294	6/8	0,77	1
9203 25F2 35	400	489	331	6/8	1,0	1
9203 26F2 35	450	594	372	7/10	1,0	1
9203 27F2 35	500	594	413	7/10	1,0	1
9203 28F2 35	560	695	451	7/10	1,0	1
9203 29F2 35	630	695	507	7/10	1,0	1

Art Nr	D	Da	Di	H1/H2	KG	VE1
Art No	[mm]		[mm]			PU1
9204 12F2 35	75	127	69	4/5	0,06	1
9204 13F2 35	90	142	84	4/5	0,07	1
9204 14F2 35	110	162	100	5/6	0,11	1
9204 15F2 35	125	162	114	5/6	0,09	1
9204 16F2 35	140	192	127	5/6	0,12	1
9204 17F2 35	160	218	146	6/8	0,24	1
9204 18F2 35	180	218	164	6/8	0,15	1
9204 19F2 35	200	273	181	6/8	0,39	1
9204 20F2 35	225	273	203	6/8	0,26	1
9204 21F2 35	250	328	226	6/8	0,53	1
9204 22F2 35	280	328	252	6/8	0,41	1
9204 23F2 35	315	378	283	6/8	0,77	1
9204 24F2 35	355	435	319	6/8	0,77	1
9204 25F2 35	400	489	359	6/8	1,00	1
9204 26F2 35	450	594	403	7/10	1,00	1
9204 27F2 35	500	594	447	7/10	1,00	1
9204 28F2 35	560	695	494	7/10	1,00	1
9204 29F2 35	630	695	555	7/10	1,00	1

Z.03 Clipse + Schellen • Clips + Clamps

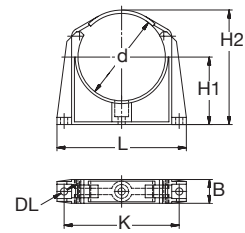
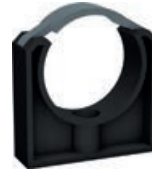
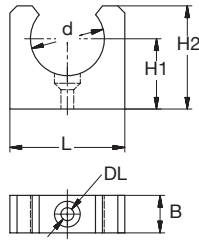

BR PE-Rohrclip schwarz

BR PE-Pipe clip black

Art Nr	d	L	B	H1	H2	DL	nL	KG	VE1	VE2
Art No	[mm]	[mm]							PU1	PU2
9301 0500 35	16	32	16	24	32	5	1	0,006	10	-
9301 0600 15	20	32	16	25	34	5	1	0,008	10	800
9301 0700 15	25	41	17	26	35	6	1	0,011	10	600
9301 0800 15	32	49	16	30	44	6	1	0,016	10	400

BR PE-Rohrclip mit PVC-Bügel schwarz

BR PE-Pipe clip with PVC-bracket black

Art Nr	d	L	B	H1	H2	K	DL	nL	KG	VE1
Art No	[mm]	[mm]								PU1
9301 090B 35	40	58	25	43	68	-	7	1	0,03	10
9301 100B 35	50	69	25	47	77	-	7	1	0,03	10
9301 110B 35	63	84	25	57	93	-	9	1	0,04	10
9301 120B 35	75	125	30	64	107	109	9	3	0,09	10
9301 130B 35	90	143	30	73	124	125	9	3	0,11	6
9301 140B 35	110	163	30	85	146	145	9	3	0,14	6
9301 150B 35	125	183	39	117	187	165	9	3	0,23	6
9301 160B 35	140	199	40	132	207	181	9	3	0,28	4
9301 170B 35	160	220	40	150	235	202	9	3	0,33	4

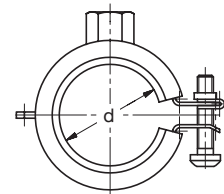
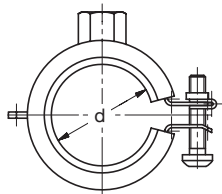

Rohrschelle STANDARD mit Gummieinlage grün

Pipe clamp STANDARD with rubber insert green

Art Nr	d	Größe/	Schrauben	Anschluß	KG	VE1	VE2
Art No	[mm]	Size [mm]	Screws	Connection		PU1	PU2
9302 0500 31	16	15 - 19	1	M8	0,046	10	100
9302 0600 31	20	21 - 23	1	M8	0,052	10	100
9302 0700 31	25	26 - 28	1	M8	0,060	10	100
9302 0800 31	32	32 - 35	1	M8	0,064	10	75
9302 0900 31	40	40 - 43	1	M8	0,08	10	50
9302 1000 31	50	48 - 53	2	M8	0,11	10	50
9302 1100 31	63	63 - 67	1	M8/10	0,12	10	50
9302 1200 31	75	75 - 80	2	M8/10	0,14	10	25
9302 1300 31	90	89 - 91	2	M8/10	0,19	10	25
9302 1400 31	110	108 - 116	2	M8/10	0,30	10	-
9302 1500 31	125	121 - 127	2	M8/10	0,33	10	-
9302 1700 31	160	159 - 162	2	M8/10	0,35	10	-

Rohrschelle STANDARD mit Gummieinlage schwarz

Pipe clamp STANDARD with rubber insert black

Art Nr	d	Größe/	Schrauben	Anschluß	KG	VE1	VE2
Art No	[mm]	Size [mm]	Screws	Connection		PU1	PU2
9302 1500 35	125	121-127	2	M8/10	0,33	10	A
9302 1700 35	160	160	2	M8/10	0,35	10	A
9302 1900 35	200	200	2	M8/10	0,37	1	-
9302 2100 35	250	250	2	M8/10	0,52	1	-

Für Kaltwasseranwendungen • For cold-water applications.
Nicht für Polypropylen • Not for Polypropylene.

Weitere Dimensionen und Ausführungen auf Anfrage.
Other dimensions and types on request.

Z.04 Montagematerial • Mounting material

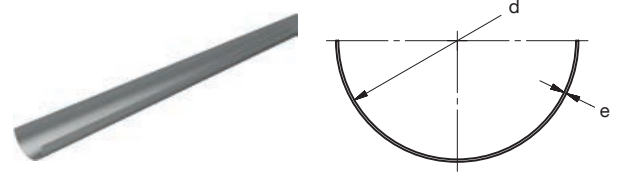
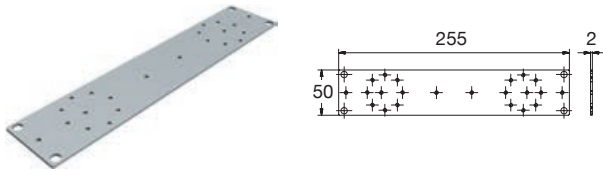

BR Montageplatte Armaturen St-verzinkt
BR Mounting plate armatures galvanized steel

BR Tragschale für Rohre
BR Support semi-tube for pipes

Art Nr	L	B	H	KG	VE1
Art No	[mm]			KG	PU1
9401 0001 09	255	50	2	0,18	1

Art Nr	d	e	L	KG	VE1
Art No	[mm]	[mm]	[m]	KG	PU1

Für Armaturen-Stichmaße 76, 100, 153 und 200 mm.
For valve tap measurements 76, 100, 153 and 200 mm.

Stahl-verzinkt • galvanized steel

9403 0730 09	25 *	0,6	3	0,60	1
9403 0830 09	32	0,6	3	0,77	1
9403 0930 09	40	0,6	3	0,95	1
9403 1030 09	50	0,6	3	1,14	1
9403 1130 09	63	0,6	3	1,50	1
9403 1230 09	75	0,6	3	1,80	1
9403 1330 09	90	0,6	3	2,05	1
9403 1430 09	110	0,6	3	2,35	1

V2A • stainless steel

9403 0730 V9	25 *	0,5	3	0,16	1
9403 0830 V9	32	0,5	3	0,21	1
9403 0930 V9	40	0,5	3	0,26	1
9403 1030 V9	50	0,5	3	0,32	1
9403 1130 V9	63	0,5	3	0,41	1
9403 1230 V9	75	0,5	3	0,48	1
9403 1330 V9	90	0,5	3	0,58	1
9403 1430 V9	110	0,5	3	0,70	1

* Für Rohre D16-25 • for pipes D16-25.

Optische Mängel sind durch die Lagerung nicht zu vermeiden.
Visual defects can not be avoided through the storage.

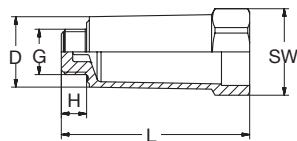

BR Abpresszapfen AG mit NBR-Runddichtring
BR Wall inlet plug male-thread with NBR-O-Ring gasket

Art Nr	G	grau	blau	rot	D	L	H	SW	KG	VE1	VE2
Art No	[Inch]	grey	blue	red	[mm]				KG	PU1	PU2
9402 0001 12	3/8	•			29	87	10	32	0,038	10	-
9402 0002 12	1/2	•			33	87	10	36	0,037	10	350
9402 0003 12	3/4	•			40	91	14	41	0,060	10	150
9402 0004 12	1/2		•		33	87	10	36	0,036	10	350
9402 0005 12	3/4		•		40	91	14	41	0,050	10	150
9402 0006 12	1/2			•	33	87	10	36	0,035	10	350
9402 0007 12	3/4			•	40	91	14	41	0,050	10	150

Ersatzdichtung • Replacement gasket

9402 0008 05	3/8	NBR O-Ring D15 x 3,0							0,001	10	-
9402 0009 05	1/2	NBR O-Ring D19,2 x 3,0							0,001	10	-
9402 0010 05	3/4	NBR O-Ring D25 x 3,0							0,002	10	-

Z.05.01 Schneiden • Cutting



HST Rohrabscneider

HST Pipe cutter

Beschreibung

Alle Rohrabscneider bestehen durch höchste Stabilität und Servicefreundlichkeit. Sie verfügen über einen im Gehäuse integrierten, herausnehmbaren Entgrater und ihr ergonomisch optimierter Handgriff sorgt für einfache Bedienbarkeit.

Merkmale

- Gehärtete PTFE beschichtetes Schneidrad
- „Made in Solingen/Germany“
- Hochfestes Gehäuse aus Aluminium Druckguss
- Im Gehäuse integrierter Entgrater

Description

All pipe cutters are characterized by the highest stability and serviceability. They have a removable deburrer integrated in the housing and their ergonomically optimized handle ensures easy operation.

Features

- Cured PTFE coated cutting wheel
- „Made in Solingen / Germany“
- High-strength aluminum die-cast body
- Integrated deburrer in the housing

Technische Änderungen vorbehalten • Specifications subject to change without notice.

Art Nr Art No	Beschreibung	Description	KG	VE1 PU1
9501 0009 30	HST Rohrabscneider weiß Größe 1, 6-76 mm für Wandstärken bis 8,6 mm, mit integriertem Entgrater	HST Pipe cutter white size 1, 6-76 mm for wall thicknesses up to 8,6 mm, with integrated deburring tool	0,90	1
9501 0010 30	HST Rohrabscneider weiß Größe 2, 50-127 mm für Wandstärken bis 19,8 mm, mit integriertem Entgrater	HST Pipe cutter white size 2, 50-127 mm for wall thicknesses up to 19,8 mm, with integrated deburring tool	2,70	1
9501 0011 30	HST Rohrabscneider weiß Größe 3, 100-170 mm für Wandstärken bis 19,8 mm, mit integriertem Entgrater	HST Pipe cutter white size 3, 100-170 mm for wall thicknesses up to 19,8 mm, with integrated deburring tool		1

Art Nr Art No	Ersatzteile	Spare parts	KG	VE1 PU1
9501 0012 30	HST Schneidrad 30 x 6,2 für Rohrabscneider Gr.1	HST Cutting wheel 30 x 6.2 for pipe cutter size 1	0,01	1
9501 0013 30	HST Schneidrad 35 x 11 für Rohrabscneider Gr.2+3	HST Cutting wheel 35 x 11 for pipe cutter size 2+3	0,01	1
9501 0014 30	HST Schneidrad 45 x 11 für Rohrabscneider Gr.2+3	HST Cutting wheel 45 x 11 for pipe cutter size 2+3	0,01	1
9501 0015 30	HST Schneidrad 51 x 11 für Rohrabscneider Gr.2+3	HST Cutting wheel 51 x 11 for pipe cutter size 2+3	0,01	1
9501 0016 30	HST Schneidrad 67 x 11 für Rohrabscneider Gr.2+3	HST Cutting wheel 67 x 11 for pipe cutter size 2+3	0,01	1
9501 0017 30	HST Schneidrad-Ersatzbolzen für Rohrabscneider Gr.1	HST Cutting wheel replacement bolt for pipe cutter size 1	0,08	1
9501 0018 30	HST Schneidrad-Ersatzbolzen für Rohrabscneider Gr.2+3	HST Cutting wheel replacement bolt for pipe cutter size 2+3	0,08	1
9501 0019 30	HST Ersatzentgrater für Rohrabscneider Gr.1-3	HST Replacement deburring tool for pipe cutter size 1-3	0,17	1



HST Rohrscheren

HST Pipe scissors

Art Nr Art No	Beschreibung	Description	KG	VE1 PU1
9501 0001 30	HSTCUT 35 Kunststoffrohr-Schere weiß 0-35 mm	HSTCUT 35 Plastic pipe scissor white 0-35 mm	0,32	1
9501 0002 30	HSTCUT 35 Ersatzklinge	HSTCUT 35 Replacement blade	0,15	1
9501 0003 30	HSTCUT 42 Kunststoffrohr-Schere weiß 0-42 mm	HSTCUT 42 Plastic pipe scissor white 0-42 mm	0,40	1
9501 0004 30	HSTCUT 42 Ersatzklinge	HSTCUT 42 Replacement blade	0,15	1
9501 0005 30	HSTCUT 50 Kunststoffrohr-Schere weiß 0-50 mm	HSTCUT 50 Plastic pipe scissor white 0-50 mm	0,51	1
9501 0006 30	HSTCUT 50 Ersatzklinge	HSTCUT 50 Replacement blade	0,15	1
9501 0007 30	HSTCUT 63 Kunststoffrohr-Schere weiß 0-63 mm	HSTCUT 63 Plastic pipe scissor white 0-63 mm	0,64	1
9501 0008 30	HSTCUT 63 Ersatzklinge	HSTCUT 63 Replacement blade	0,15	1





ROLLER SmartCut

ROLLER Akku-SmartCut

Beschreibung

Handlicher, superleichter robuster Elektro-/Akku-Rohrabschneider für Kunststoff- und Verbundrohre von D10 bis 40mm.

Merkmale

- Zum rechtwinkligen und schnellen Trennen von Rohren
- Superhandlich, mobil, superleicht, Gewicht nur 1,9 bzw 2,1 kg in der Akkuversion.
- Einfach zu bedienen, keine Einstellarbeiten erforderlich
- Stabile, verwindungsfreie Aluminiumkonstruktion für rechtwinkligen Schnitt.
- Optimal eingestellte Trenngeschwindigkeit (130 min-1) für schnelles und ruhiges Trennen.
- Robustes wartungsfreies Getriebe, präzis kugel- und nadelgelagert, für lange Lebensdauer.
- Elektroversion: Bewährter, durchzugsstarker Gleichstrommotor 230 V, 130 W, mit Sicherheits-Tippschalter.
- Akkuversion: mit 10,8 V Li-Ion Akku und 1,3 Ah Kapazität für extrem lange Laufzeit. Überhitzungs- und Überladeschutz. Schnell-Ladegerät für kurze Ladezeiten. Kein Memory-Effekt für maximale Akkuleistung.

Description

Handy, ultra light, robust (cordless) pipe cutter for plastic and composite pipes from D10 to 40mm.

Features

- For right-angled and fast cutting of pipes.
- Ultra handy, mobile, ultra light, drive unit only 1.9 respectively 2.1 kg for the accu-version.
- Easy to operate, no setting work necessary.
- Strong, distortion-free aluminium structure for right angle cutting.
- Optimally set cutting speed (130 rpm) for fast, quiet cutting.
- Robust, maintenance-free gear, precision ball and needle bearing, for long life.
- 230V-version: Proven, powerful 230 V 130 W DC motor, with safety switch.
- Accu-version: with 10.8 V Li-Ion accu and 1.3 Ah capacity for extremely long running. Overheating and overloading protection. Rapid charger for short charging times. No memory effect for maximum battery performance.

Technische Änderungen vorbehalten • Specifications subject to change without notice.



Art Nr Art No	Beschreibung	Description
9501 0020 30	ROLLER SmartCut - 230 V Basic Antriebsmaschine mit Rohrauflagen, Einmaulschlüssel SW8, ohne Schneidrad, in Tragetasche.	Drive unit with pipe rests, single open ended wrench size 8, without cutting wheel, in carrying bag.
9501 0021 30	ROLLER Akku-SmartCut - 10,8 V Basic Antriebsmaschine mit Rohrauflagen, Akku Li-Ion 10,8 V, 1,3 Ah, Schnellladegerät, Einmaulschlüssel SW8, ohne Schneidrad, in Tragetasche.	Drive unit with pipe rests, Li-Ion 10.8 V, 1.3 Ah, rapid charger, single open ended wrench size 8, without cutting wheel, in carrying bag.
9501 0022 30	ROLLER Schneidrad V für Kunststoff- und Verbundrohre.	ROLLER cutting wheel V for plastic and multi-layer-composite-pipes.
	Zubehör	Accessories
9501 0023 30	Akku Li-Ion 10,8 V, 1,3 Ah	Accu Li-Ion 10.8 V, 1.3 Ah
9501 0024 30	Schnellladegerät, 230 V, 65 W	Rapid charger, 230 V, 65 W
9501 0025 30	Tragetasche	Carrying bag





ROLLER Disc 100

Beschreibung

Kompakte, mobile Rohrtrennmaschine zum schnellen rechtwinkligen Trennen von Kunststoff- und Verbundrohren von D40 bis 110 mm.

Merkmale

- Zum rechtwinkligen und schnellen Trennen von Rohren
- Einfach zu bedienen, keine Einstellarbeiten, kein Werkzeug erforderlich
- Stabile, verwindungsfreie Gusskonstruktion für rechtwinkligen Schnitt. Leichtes Trennen der Rohre durch speziell ausgebildetes Schneidrad.
- Mit 4 stabilen kugelgelagerten Laufrollen aus gehärtetem Präzisions-Stahlrohr für reibungsarmes Drehen der zu trennenden Rohre.
- Optimal eingestellte Trenngeschwindigkeit (115 min-1) für schnelles ruhiges Trennen.
- Robustes, wartungsfreies Getriebe mit hohem Wirkungsgrad.
- Bewährter, durchzugsstarker 1200 W Motor mit Sicherheits-Fußschalter.
- Geringes Gewicht, leicht tragbar, nur 16,8 kg.

Description

Compact, lightweight, robust pipe cutting machine for fast and right-angled cutting of plastic and composite pipes from D40 to 110 mm.

Features

- For right-angled and fast cutting of pipes.
- Easy to operate, no setting work, no tools necessary.
- Strong, distortion-free cast structure for right angle cutting. Easy cutting of the pipes by specially designed cutter wheel.
- With 4 strong, hardened precision tubular steel running rollers for low-friction-rotation of the pipes.
- Optimally set cutting speed (115 rpm) for fast, quiet cutting.
- Robust, maintenance-free gear with high efficiency.
- Proven, powerful 1200 W motor with safety foot switch.
- Low weight, easily portable, only 16.8 kg.

Technische Änderungen vorbehalten • Specifications subject to change without notice.

Art Nr Art No	Beschreibung	Description
9501 0026 30	ROLLER Disc 100 Basic Antriebsmaschine mit Laufrollen aus gehärtetem Präzisions-Stahlrohr, Sicherheits-Fußschalter, Ringschlüssel, ohne Schneidrad.	Drive unit with running rollers of hardened precision tubular steel, safety foot switch, ring spanner, without cutting wheel.
9501 0028 30	ROLLER Schneidrad V, s 10 für Kunststoff- und Verbundrohre, Wanddicke s ≤ 10 mm.	ROLLER cutting wheel V, s 10 for plastic and multi-layer-composite-pipes, wall thickness s ≤ 10 mm.





ROLLER Disc 225

Beschreibung

Kompakte, mobile Rohrtrennmaschine zum schnellen rechtwinkligen Trennen von Kunststoff- und Verbundrohren von D40 bis 225 mm.

Merkmale

- Zum rechtwinkligen und schnellen Trennen von Rohren
- Einfach zu bedienen, keine Einstellarbeiten, kein Werkzeug erforderlich
- Stabile, verwindungsfreie Gusskonstruktion für rechtwinkligen Schnitt. Leichtes Trennen der Rohre durch speziell ausgebildetes Schneidrad.
- Mit 4 stabilen kugelgelagerten Laufrollen aus gehärtetem Präzisions-Stahlrohr für reibungsarmes Drehen der zu trennenden Rohre.
- Optimal eingestellte Trenngeschwindigkeit (115 min⁻¹) für schnelles ruhiges Trennen.
- Robustes, wartungsfreies Getriebe mit hohem Wirkungsgrad.
- Bewährter, durchzugsstarker 1200 W Motor mit Sicherheits-Fußschalter.
- Kompakt, gut transportabel, nur 37 kg. Mit praktischem Fahrgestell mit zwei Gummirädern für einfachen Transport.

Description

Compact, lightweight, robust pipe cutting machine for fast and right-angled cutting of plastic and composite pipes from D40 to 225 mm.

Features

- For right-angled and fast cutting of pipes.
- Easy to operate, no setting work, no tools necessary.
- Strong, distortion-free cast structure for right angle cutting. Easy cutting of the pipes by specially designed cutter wheel.
- With 4 strong, hardened precision tubular steel running rollers for low-friction-rotation of the pipes.
- Optimally set cutting speed (115 rpm) for fast, quiet cutting.
- Robust, maintenance-free gear with high efficiency.
- Proven, powerful 1200 W motor with safety foot switch.
- Compact, easily transportable, only 37 kg. With practical chassis with two rubber tired wheels for easy transport.

Technische Änderungen vorbehalten • Specifications subject to change without notice.

Art Nr	Beschreibung	Description
Art No		
9501 0027 30	ROLLER Disc 225 Basic Antriebsmaschine mit Laufrollen aus gehärtetem Präzisions-Stahlrohr, Sicherheits-Fußschalter, Ringschlüssel, ohne Schneidrad, 2 Stück höhenverstellbare Rohrauflagen D100-225 mm.	Drive unit with running rollers of hardened precision tubular steel, safety foot switch, ring spanner, without cutting wheel, 2 height adjustable pipe rests D100-225 mm.
9501 0028 30	ROLLER Schneidrad V, s 10 für Kunststoff- und Verbundrohre, Wanddicke s ≤ 10 mm.	ROLLER cutting wheel V, s 10 for plastic and multi-layer-composite-pipes, wall thickness s ≤ 10 mm.
9501 0029 30	ROLLER Schneidrad P, s 21 für Kunststoff- und Verbundrohre, Wanddicke s ≤ 21 mm.	ROLLER cutting wheel P, s 21 for plastic and multi-layer-composite-pipes, wall thickness s ≤ 21 mm.





Quality for Professionals



Art Nr	Inhalt Content [ml]	Beschreibung	Description	KG	VE1
Art No					PU1
9502 0001 30	125	PVC-U/C ABS Reiniger	PVC-U/C ABS Cleaner	0,15	20
9502 0002 30	1000	für Rohrklebeverbindungen	for pipe bonding connections	0,94	8



Art Nr	Inhalt Content [ml]	Beschreibung	Description	KG	VE1
Art No					PU1
9502 0003 30	1000	PE/PP/PB/PVDF Spezial-Reiniger für Kunststoff-Schweißverbindungen	PE/PP/PB/PVDF Special Cleaner for plastic welding joints	0,860	8



Art Nr	Inhalt Content [St/pc]	Beschreibung	Description	KG	VE1
Art No					PU1
9502 0004 30	100	PE/PP/PB/PVDF Spezial-Reinigungstücher für Kunststoff-Schweißverbindungen	PE/PP/PB/PVDF Special Cleaning tissues for welding of plastic materials	0,330	8

Z.05.03 Kleben • Bonding



Art Nr	Inhalt Content [g]	Beschreibung	Description	KG	VE1
Art No					PU1
9503 0001 30	250	PVC-U Spezial-Klebstoff	PVC-U special Adhesive	0,30	24
9503 0003 30	1000	für zugfeste Rohrverbindungen	for (rigid) fittings and pipes	1,13	8



Art Nr	Beschreibung	Description	Für Formteile For fittings	KG	VE1
Art No					PU1
9503 0004 30	Pinsel rund Gr.4	Brush round size 4	10 - 12 mm	0,01	10
9503 0005 30	Pinsel rund Gr.12	Brush round size 12	16 - 32 mm	0,01	10
9503 0006 30	Pinsel flach Gr.25 x 3 mm	Brush flat size 25 x 3 mm	40 - 63 mm	0,01	12
9503 0007 30	Pinsel flach Gr.50 x 3 mm	Brush flat size 50 x 3 mm	75 - 160 mm	0,02	12

Muffen-Handschweißgeräte

Set = mit Schweißwerkzeugen (Typ A)

Socket hand-polywelder

Set = with welding tools (Typ A)

Art Nr	Beschreibung	Description	VE1
Art No			PU1
9504 0001 30	OM 10050 ECO Set - 230 V, d20-32		1



9504 0002 30	OM 1045 ECO Set - 230 V, d20-32 mit Ständer und Box • with support and box		1
--------------	---	--	---



9504 0003 30	OM 1045 Set - 230 V, d16-63 mit Ständer und Box • with support and box		1
--------------	---	--	---

9004 0004 30	OM 1045 Set - 110 V , d16-63 mit Ständer und Box • with support and box		1
--------------	---	--	---



9504 0005 30	OM 10125 - 230V , 1,5 kW, bis d125 mit Ständer und Box • with support and box		1
--------------	--	--	---

Ersatzteile		Replacement parts	
9504 0010 30	OM Heizelement 1000 W	OM Heating element 1000 W	1
9504 0011 30	OM Kunststoff-Griff	OM Plastic handle	1
9504 0012 30	OM Platine Temp.-Anzeige	OM Circuit Board (temperature)	1
9504 0013 30	OM Thermostat	OM Thermostat	1
9504 0014 30	OM Box rot	OM Box red	1
9504 0015 30	OM Box grün	OM Box green	1



Schweißwerkzeug (Muffe + Dorn) Teflon-beschichtet Typ-A *
Socket-welding tool (socket + plug) Teflon-coated Type-A *

Art Nr	d	KG	VE1
Art No	[mm]		PU1
9504 0500 09	16	0,080	1
9504 0600 09	20	0,10	1
9504 0700 09	25	0,14	1
9504 0800 09	32	0,22	1
9504 0900 09	40	0,33	1
9504 1000 09	50	0,47	1
9504 1100 09	63	0,67	1
9504 1200 09	75	0,89	1
9504 1300 09	90	1,18	1
9504 1400 09	110	1,95	1
9504 1500 09	125	2,25	1

Art Nr	Beschreibung	Description	VE1
Art No			PU1
9504 0020 21	Schablone Muffentiefe d16 – 75 mm	Gauge PP-socket welding depth d16 – 75 mm	1

* nach DVS 2208 • According to DVS 2208.





OM-7125 Set

Muffen-Schweiß-Maschine für Polypropylen-Rohre und Formteile von 32 bis 125 mm
 Socket fusion welding machine for Polypropylene pipes and fittings from 32 – 125 mm

Beschreibung

Hezelement-Muffen-Schweißmaschine mit beweglichen Schlitten, auf denen prismatische Klemmen montiert sind, um eine automatische Selbstzentrierung aller Arten von Rohren und Formteilen zu ermöglichen. Das Hezelement lässt sich leicht per Hand entnehmen.
 Das Schweißen erfolgt halbautomatisch durch einen Federmechanismus in der Maschine. Die Maschine wird im Stahlkasten zum leichten Transport und zur Verwendung als Werkbank geliefert.

Merkmale

- Stahl Transportbox/Werkbank
- Halbautomatischer Federmechanismus
- Automatische Selbstzentrierung
- Teflon beschichtete Schweiß-Einsätze

Spezifikationen

Für Rohrgrößen: D 32 – 125 mm
 Temperatur: 50 – 300°C
 Gesamtgewicht: 80 kg
 Elektr. Anschluss: 230 V / 50/60 Hz
 Leistung: 1,5 kW
 Volumen: 60 x 80 x 85 cm

Lieferumfang

Verpackung beinhaltet Schweißmaschine, austauschbares Hezelement, Stahl-Transportbox/Werkbank, Rohrstütze, Satz Schweiß-Einsätze von 50 bis 125 mm Typ A (DVS 2208).

Description

Socket fusion polywelder equipped with movement slides on which prismatic clamps are placed to allow an automatic self-centering of any kinds of pipes and fittings. The Polywelder can be easily extracted by hand.
 Welding is made in a semi-automatic way due to a spring loading device of the machine. The machine is supplied in steel box for easy movement of the polywelder and for using as a workbench.

Features

- Steel box/workbench
- Semi-automatic spring mechanism
- Automatic self-centering
- Teflon plated bushes

Specifications

Fuses pipe sizes: D 32 – 125 mm
 Temperature: 50 – 300°C
 Weight: 80 kg
 Power supply: 230 V / 50/60 Hz
 Power: 1.5 kW
 Volume: 60 x 80 x 85 cm

Scope of delivery

Packaging includes welding machine, extractable polywelder, steel transport box/work bench, pipe support tripod, set of bushes from 50 to 125 mm type A (DVS 2208).

Technische Änderungen vorbehalten • Specifications subject to change without notice.

Art Nr	Beschreibung	Description	VE1
Art No			PU1
9504 0006 30	OM 7125 Set - 230 V		1

Ersatzteile		Replacement parts	
9504 0005 30	OM 10125/TF Hezelement	OM 10125/TF Heating element	1



SPIDER™ 125 mit universal Einspannvorrichtung

Muffen-Verbindungs-Werkzeug für Polypropylen-Rohre von 63 bis 125 mm

SPIDER™ 125 with universal clamping

Socket fusion tool for 63 to 125 mm Polypropylene pipe

Beschreibung

Der SPIDER™ 125 mit Universal-Spannsystem ist die bevorzugte Ausrüstung für schnelle und genaue Muffen-Schweißungen von 63 bis 125 mm Polypropylen-Rohr. Das leichte, kompakte Gerät verfügt über ein Schneckengetriebe mit Parallelenkersystem, um Rohr und Formteil gleichmäßig und kontrolliert zu bewegen. Es verfügt über ein Universal-Spannsystem, das jede Größe von Rohr oder Verbindung aufnehmen kann, wodurch die Notwendigkeit für Einsätze entfällt. Die Eigenschaften des SPIDERS erlauben es einem einzelnen Techniker, das Rohr richtig auszurichten, zu erwärmen, zu schweißen und abzukühlen. Da der SPIDER ein nicht rückfahrendes Getriebe hat, wird während des gesamten Prozesses ein konstanter Druck beibehalten. Der SPIDER hat sich als außergewöhnliches Werkzeug für die Durchführung von Schweißverbindungen über Kopf, vertikalen und engen Arbeitsräumen erwiesen. Für Rohrgrößen im Bereich von 63 bis 125 mm steht ein komplettes Sortiment an Heizelementen und Schweißbeinsätzen zur Verfügung.

Merkmale

- Handbetrieben
- Keine Einsätze erforderlich
- Universal-Spannbackensystem passt zu allen Rohr- und Formteilmfabrikaten
- Nicht rückfahrendes Getriebe, selbstsichernd
- Zwei-Punkt-Stützgriff
- Leicht und kompakt
- Selbstzentrierend
- Breite Spannbacken sorgen für Stabilität am Rohr

Spezifikationen

Für Rohrgrößen: D 63 - 125 mm
 Maschinengewicht: 6,8 kg (15 lbs.)
 Maximale Hublänge: 193 mm (7,6 Zoll)

Lieferumfang

Verpackung beinhaltet SPIDER-Maschine und Tragetasche. Heizelement und Muffen-Schweißwerkzeuge sind separat erhältlich.

Description

The SPIDER™ 125 with Universal Clamping system is the preferred equipment for quick and accurate socket-welding field installations from 63 to 125 mm Polypropylene pipe. The lightweight, compact device features a worm gear drive with parallel link system to bring pipe and fittings together aligned and moving under control. It features a Universal Clamping system that can accommodate any size of pipe or coupling, eliminating the need for inserts. The features of the SPIDER allow a single technician to properly align, heat, weld and cool the pipe. Because the SPIDER is non back-driveable, constant pressure is maintained throughout the process. The SPIDER has proven to be an exceptional tool for performing socket-weldings in overhead, vertical and tight work spaces. A full assortment of heaters and heater adapters are available for pipe sizes from 63 to 125 mm range.

Features

- Hand-powered
- No inserts necessary
- Universal Clamping jaw system fits all pipe brands and fittings
- Non back-driveable gearing, self-locking
- Two-position support handle
- Lightweight and compact
- Self-centering
- Wide jaws provide stability on pipe

Specifications

Fuses pipe sizes: D 63 – 125 mm
 Machine Weight: 6.8 kg (15 lbs.)
 Maximum Stroke Length: 193 mm (7.6 inch)

Scope of delivery

Packaging includes SPIDER fusion machine and carrying case. Heater and other socket-welding tools sold separately.

Technische Änderungen vorbehalten • Specifications subject to change without notice.

Teil / Item **9504 0021 30**

Art Nr	Beschreibung	Description	VE1
Art No			PU1
9504 0021 30	SPIDER 125 mit Universal-Einspannvorrichtung	SPIDER 125 with universal clamping	1





OM-SP250 Set

Stumpf-Schweiß-Maschine 230 V mit Zubehör für PE/PP-Rohre und Formteile von 75 bis 250 mm
 Butt-welding machine 230 V with accessories for PE/PP-pipes and fittings from 75 to 250 mm

Beschreibung

Stumpf-Schweiß-Maschine für Rohre und Formteile aus PE/PP und anderen thermoplastischen Materialien. Im Set mit allen Reduzierungen.

Merkmale

- Basisgerät mit vier, auf einem fahrbaren Schlitten befestigte, 250 mm Spannbacken.
- Gehärtete verchromte Führungen.
- Dritter justierbarer Spannbacken.
- Leckagefreie Schnellverschlusskupplungen
- Automatische Trennung vom Heizelement
- Heizelement Teflon beschichtet und thermostatisch geregelt.
- Elektrischer Rotations-Schäler als Planhobel

Spezifikationen

Für Rohrgrößen: D 75 – 250 mm
 Temperatur: 50 – 300°C
 Maximaler Druck: 150 bar
 Gesamtgewicht: 167 kg
 Maximalleistung: 3 kW / 230 V / 50/60 Hz
 Volumen: 120 x 80 x 74 cm

Lieferumfang

Verpackung beinhaltet Schweißmaschine, einstellbares Heizelement, elektronische Thermostat-Box, elektrischen Planhobel, Paar flexible Hydraulik-Schläuche, Stahl-Box für Heizelement und Planhobel, Reduktionen (250-225/200/180/160/140/125/110/90/75) und Holz-Transportkiste.

Description

Butt-welding machine for pipes and fittings in PE/PP and other thermoplastic materials. As a set with all reductions.

Features

- Basic machine with four 250 mm main jaws arranged on a sliding frame
- Sliding hardened chromate guides
- Third adjustable jaw
- Quick hydraulic antidrop release couplings
- Automatic breakaway of thermoplate
- Heating element Teflon-coated and thermostatically controlled
- Electric rotating scraper as planing tool

Specifications

Fuses pipe sizes: D 75 – 250 mm
 Temperature: 50 – 300°C
 Maximum pressure: 150 bar
 Total weight: 167 kg
 Maximum power: 3 kW / 230 V / 50/60 Hz
 Volume: 120 x 80 x 74 cm

Scope of delivery

Packaging includes welding machine, adjustable heating element, electronic thermostat box, electric planing tool, pair of flexible hydraulic pipes, steel box for heating element and electric planing tool, reducer brackets (250-225/200/180/160/140/125/110/90/75) and wooden carrying case.

Technische Änderungen vorbehalten • Specifications subject to change without notice.

Teil / Item **9505 0001 30**

Art Nr	Beschreibung • Description	VE1
Art No		PU1
9505 0001 30	OM-SP250 Set - 230 V	1



OM-SP315 Set

Stumpf-Schweiß-Maschine 230 V mit Zubehör für PE/PP-Rohre und Formteile von 90 bis 315 mm
 Butt-welding machine 230 V with accessories for PE/PP-pipes and fittings from 90 to 315 mm

Beschreibung

Stumpf-Schweiß-Maschine für Rohre und Formteile aus PE/PP und anderen thermoplastischen Materialien. Im Set mit allen Reduzierungen.

Merkmale

- Basisgerät mit vier, auf einem fahrbaren Schlitten befestigte, 315 mm Spannbacken.
- Gehärtete verchromte Führungen.
- Dritter justierbarer Spannbacken.
- Leckagefreie Schnellverschlusskupplungen
- Automatische Trennung vom Heizelement
- Heizelement Teflon beschichtet und thermostatisch geregelt.
- Elektrischer Rotations-Schäler als Planhobel

Spezifikationen

Für Rohrgrößen: D 90 – 315 mm
 Temperatur: 50 – 300°C
 Maximaler Druck: 150 bar
 Gesamtgewicht: 209 kg
 Maximalleistung: 3,8 kW / 230 V / 50/60 Hz
 Volumen: 120 x 80 x 84 cm

Lieferumfang

Verpackung beinhaltet Schweißmaschine, einstellbares Heizelement, elektronische Thermostat-Box, elektrischen Planhobel, Paar flexible Hydraulik-Schläuche, Stahl-Box für Heizelement und Planhobel, Reduktionen (315-280/250 und 250-225/200/180/160/140/125/110/90) und Holz-Transportkiste.

Description

Butt-welding machine for pipes and fittings in PE/PP and other thermoplastic materials. As a set with all reductions.

Features

- Basic machine with four 315 mm main jaws arranged on a sliding frame
- Sliding hardened chromate guides
- Third adjustable jaw
- Quick hydraulic antidrop release couplings
- Automatic breakaway of thermoplate
- Heating element Teflon-coated and thermostatically controlled
- Electric rotating scraper as planing tool

Specifications

Fuses pipe sizes: D 90 – 315 mm
 Temperature: 50 – 300°C
 Maximum pressure: 150 bar
 Total weight: 209 kg
 Maximum power: 3.8k W / 230 V / 50/60 Hz
 Volume: 120 x 80 x 84 cm

Scope of delivery

Packaging includes welding machine, adjustable heating element, electronic thermostat box, electric planing tool, pair of flexible hydraulic pipes, steel box for heating element and electric planing tool, reducer brackets (315-280/250 and 250-225/200/180/160/140/125/110/90) and wooden carrying case.

Technische Änderungen vorbehalten • Specifications subject to change without notice.

Teil / Item **9505 0002 30**

Art Nr	Beschreibung • Description	VE1
Art No		PU1
9505 0002 30	OM-SP315 Set - 230 V	1



OM-SP500 Set

Stumpf-Schweiß-Maschine 230 V mit Zubehör für PE/PP-Rohre und Formteile von 250 bis 500 mm
 Butt-welding machine 230 V with accessories for PE/PP-pipes and fittings from 250 to 500 mm

Beschreibung

Stumpf-Schweiß-Maschine für Rohre und Formteile aus PE/PP und anderen thermoplastischen Materialien. Im Set mit allen Reduzierungen.

Merkmale

- Basisgerät mit vier, auf einem fahrbaren Schlitten befestigte, 500 mm Spannbacken.
- Gehärtete verchromte Führungen.
- Dritter justierbarer Spannbacken.
- Leckagefreie Schnellverschlusskupplungen
- Automatische Trennung vom Heizelement
- Heizelement Teflon beschichtet und thermostatisch geregelt.
- Elektrischer Rotations-Schäler als Planhobel

Spezifikationen

Für Rohrgrößen: D 250 – 500 mm
 Temperatur: 50 – 300°C
 Maximaler Druck: 150 bar
 Gesamtgewicht: 475 kg
 Maximalleistung: 5,5 kW / 230 V / 50/60 Hz
 Volumen: 120 x 80 x 94 cm + 120 x 80 x 109 cm

Lieferumfang

Verpackung beinhaltet Schweißmaschine, einstellbares Heizelement, elektronische Thermostat-Box, elektrischen Planhobel, Paar flexible Hydraulik-Schläuche, Stahl-Box für Heizelement und Planhobel, Reduktionen (500-450/400/355/315 und 315-280/250) und zwei Holz-Transportkisten.

Description

Butt-welding machine for pipes and fittings in PE/PP and other thermoplastic materials. As a set with all reductions.

Features

- Basic machine with four 500 mm main jaws arranged on a sliding frame
- Sliding hardened chromate guides
- Third adjustable jaw
- Quick hydraulic antidrop release couplings
- Automatic breakaway of thermoplate
- Heating element Teflon-coated and thermostatically controlled
- Electric rotating scraper as planing tool

Specifications

Fuses pipe sizes: D 250 – 500 mm
 Temperature: 50 – 300°C
 Maximum pressure: 150 bar
 Total weight: 475 kg
 Maximum power: 5.5 kW / 230 V / 50/60 Hz
 Volume: 120 x 80 x 94 cm + 120 x 80 x 109 cm

Scope of delivery

Packaging includes welding machine, adjustable heating element, electronic thermostat box, electric planing tool, pair of flexible hydraulic pipes, steel box for heating element and electric planing tool, reducer brackets (500-450/400/355/315 and 315-280/250) and two wooden carrying cases.

Technische Änderungen vorbehalten • Specifications subject to change without notice.

Teil / Item **9505 0003 30**

Art Nr	Beschreibung • Description	VE1
Art No		PU1
9505 0003 30	OM-SP500 Set - 230 V	1



HST EasyWeld 110

inkl. Horizontalverstellung und manuellem Planhobel
with horizontal Adjustability and manuel planer

Beschreibung

Stumpf-Schweiß-Maschine zum einfachen und mobilen Stumpf-Schweißen von PE/PP-Rohren und Formteilen für alle Druckstufen von D 20 bis 110 mm. Grundmaschine inkl. Grundspannklemmen D 20 - 110 mm, montiert auf einer pulverbeschichteten Grundplatte.

Merkmale

- Grundspannklemmen sind beidseitig, jeweils um 15° zu verstellen.
- Grundspannklemmen verfügen über horizontale Verstellmöglichkeiten (Vorteile beim Segmentschweißen).
- Mechanischer Planhobel inkl. Horizontalverstellung und zweifach Wendemesser.
- Elektronisch geregeltes und PTFE-beschichtetes Hezelement.
- Tischhalterungen für Hezelement und optional für Hobel.
- Hochfester Stahlblech-Transportkoffer.

Spezifikationen

Für Rohrgrößen: D 20 – 110 mm
Stromversorgung: 230 V oder 110 V
Leistung Hezelement/Planhobel: 800/- Watt
Gesamtgewicht: 31,9 kg
Volumen: 500 x 450 x 350 cm
Herstellergarantie: 12 Monate

Lieferumfang

Transportkiste beinhaltet Schweißmaschine, Hezelement, Planhobel, Reduzierungen (jeweils 8 St./Dimension 20/25/32/40/50/63/75/90) und Zubehör (Bedienungsanleitung, 2x Inbusschlüssel).

Description

Butt-welding machine for easy and mobile butt-welding of PE/PP-pipes and fittings, for all pressure ratios, from D 20 to 110 mm. Basic machine chassis featuring clamps for D 20 - 110 mm, set on powder-coated base panel.

Features

- Clamps on machine chassis swiveling by up tp 15° degrees.
- Clamps mechanically adjustable horizontally (for more efficient placement in segmented bend applications).
- Mechanic, horizontally adjustable facing tool with two-edge useable facing blade.
- Electronically controlled, PTFE-coated heating element.
- Tabletop stands for heating element and optional for planer.
- High-spec metal transport casel

Specifications

Fuses pipe sizes: D 20 – 110 mm
Power supply: 230 V or 110 V
Power Heating element/Planer: 800/- Watt
Total weight: 31.9 kg
Volume: 500 x 450 x 350 cm
Manufacturer warranty: 12 months

Scope of delivery

Transport case incl. welding machine, heating element, facing tool, reducers (set of 8 for every size D20/25/32/40/50/63/75/90) and accessories (User's manual, 2x Allen wrenches).

Technische Änderungen vorbehalten • Specifications subject to change without notice.

Art Nr	Beschreibung	Description	VE1
Art No			PU1
9505 0020 30	HST EasyWeld 110 - 230 V		1
9505 0021 30	HST EasyWeld 110 - 110 V		1
	Optionen	Optional	
9505 0026 30	Schmale Grundspannwerkzeuge rechts/links	Narrow-profile clamps RH, LH for machine chassis	1
9505 0027 30	Halter Vorschweißbund	Support tool for Flange adaptor spigot	1
9505 0029 30	Tischhalterung Planhobel	Tabletop stand for facing tool	1



HST EasyWeld 110 E

inkl. Horizontalverstellung und elektrischem Planhobel
with horizontal Adjustability and Power facing tool

Beschreibung

Stumpf-Schweiß-Maschine zum einfachen und mobilen Stumpf-Schweißen von PE/PP-Rohren und Formteilen für alle Druckstufen von D 20 bis 110 mm. Grundmaschine inkl. Grundspannklemmen D 20 - 110 mm, montiert auf einer pulverbeschichteten Grundplatte.

Merkmale

- Grundspannklemmen sind beidseitig, jeweils um 15° zu verstellen.
- Grundspannklemmen verfügen über horizontale Verstellmöglichkeiten (Vorteile beim Segmentschweißen).
- Elektrischer Planhobel inkl. Horizontalverstellung und zweifach Wendemesser.
- Elektronisch geregeltes und PTFE-beschichtetes Hezelement.
- Tischhalterungen für Hezelement und optional für Hobel.
- Hochfester Stahlblech-Transportkoffer.

Spezifikationen

Für Rohrgrößen: D 20 – 110 mm
Stromversorgung: 230 V oder 110 V
Leistung Hezelement/Planhobel: 800/560 Watt
Gesamtgewicht: 40,1 kg
Volumen: 500 x 450 x 350 cm
Herstellergarantie: 12 Monate

Lieferumfang

Transportkiste beinhaltet Schweißmaschine, Hezelement, Planhobel, Reduzierungen (jeweils 8 St./Dimension 20/25/32/40/50/63/75/90) und Zubehör (Bedienungsanleitung, 2x Inbusschlüssel).

Description

Butt-welding machine for easy and mobile butt-welding of PE/PP-pipes and fittings, for all pressure ratios, from D 20 to 110 mm. Basic machine chassis featuring clamps for D 20 - 110 mm, set on powder-coated base panel.

Features

- Clamps on machine chassis swiveling by up to 15° degrees.
- Clamps mechanically adjustable horizontally (for more efficient placement in segmented bend applications).
- Electrical, horizontally adjustable facing tool with two-edge useable facing blade.
- Electronically controlled, PTFE-coated heating element.
- Tabletop stands for heating element and optional for planer.
- High-spec metal transport case

Specifications

Fuses pipe sizes: D 20 – 110 mm
Power supply: 230 V or 110 V
Power Heating element/Planer: 800/560 Watt
Total weight: 40.1 kg
Volume: 500 x 450 x 350 cm
Manufacturer warranty: 12 months

Scope of delivery

Transport case incl. welding machine, heating element, facing tool, reducers (set of 8 for every size D20/25/32/40/50/63/75/90) and accessories (User's manual, 2x Allen wrenches).

Technische Änderungen vorbehalten • Specifications subject to change without notice.

Art Nr	Beschreibung	Description	VE1
Art No			PU1
9505 0022 30	HST EasyWeld 110 E - 230 V		1
9505 0023 30	HST EasyWeld 110 E - 110 V		1
	Optionen	Optional	
9505 0026 30	Schmale Grundspannwerkzeuge rechts/links	Narrow-profile clamps RH, LH for machine chassis	1
9505 0027 30	Halter Vorschweißbund	Support tool for Flange adaptor spigot	1
9505 0028 30	Vertikalverstellung	Vertical adjustability	1
9505 0029 30	Tischhalterung Planhobel	Tabletop stand for facing tool	1



HST EasyWeld 110 T

inkl. Höhen- und Seitenverstellung und elektrischem Planhobel
with horizontal and vertical Adjustability and Power facing tool

Beschreibung

Stumpf-Schweiß-Maschine zum einfachen und mobilen Stumpf-Schweißen von PE/PP-Rohren und Formteilen für alle Druckstufen von D 20 bis 110 mm. Grundmaschine inkl. Grundspannklemmen D 20 - 110 mm, montiert auf einer pulverbeschichteten Grundplatte.

Merkmale

- Grundspannklemmen sind beidseitig, jeweils um 15° zu verstellen.
- Grundspannklemmen verfügen über horizontale und vertikale Verstellmöglichkeiten (Vorteile beim Segmentschweißen).
- Elektrischer Planhobel inkl. Horizontalverstellung und zweifach Wendemesser.
- Elektronisch geregeltes und PTFE-beschichtetes Hezelement.
- Tischhalterungen für Hezelement und optional für Hobel.
- Hochfester Stahlblech-Transportkoffer.

Spezifikationen

Für Rohrgrößen: D 20 – 110 mm
Stromversorgung: 230 V oder 110 V
Leistung Hezelement/Planhobel: 800/560 Watt
Gesamtgewicht: 40,1 kg
Volumen: 560 x 450 x 350 cm
Herstellergarantie: 12 Monate

Lieferumfang

Transportkiste beinhaltet Schweißmaschine, Hezelement, Planhobel, Reduzierungen (jeweils 8 St./Dimension 20/25/32/40/50/63/75/90) und Zubehör (Bedienungsanleitung, 2x Inbusschlüssel).

Description

Butt-welding machine for easy and mobile butt-welding of PE/PP-pipes and fittings, for all pressure ratios, from D 20 to 110 mm. Basic machine chassis featuring clamps for D 20 - 110 mm, set on powder-coated base panel.

Features

- Clamps on machine chassis swiveling by up tp 15° degrees.
- Clamps mechanically adjustable horizontally and vertically (for more efficient placement in segmented bend applications).
- Electrical, horizontally adjustable facing tool with two-edge useable facing blade.
- Electronically controlled, PTFE-coated heating element.
- Tabletop stands for heating element and optional for planer.
- High-spec metal transport case

Specifications

Fuses pipe sizes: D 20 – 110 mm
Power supply: 230 V or 110 V
Power Heating element/Planer: 800/560 Watt
Total weight: 40.1 kg
Volume: 560 x 450 x 350 cm
Manufacturer warranty: 12 months

Scope of delivery

Transport case incl. welding machine, heating element, facing tool, reducers (set of 8 for every size D20/25/32/40/50/63/75/90) and accessories (User's manual, 2x Allen wrenches).

Technische Änderungen vorbehalten • Specifications subject to change without notice.

Art Nr	Beschreibung	Description	VE1
Art No			PU1
9505 0024 30	HST EasyWeld 110 T - 230 V		1
9505 0025 30	HST EasyWeld 110 T - 110 V		1
	Optionen	Optional	
9505 0026 30	Schmale Grundspannwerkzeuge rechts/links	Narrow-profile clamps RH, LH for machine chassis	1
9505 0027 30	Halter Vorschweißbund	Support tool for Flange adaptor spigot	1
9505 0029 30	Tischhalterung Planhobel	Tabletop stand for facing tool	1





HST-WeldControl 2.0 - 250 Set

inkl. Reduzierungen DA75 - 225
with Reducers DA75 - 225

Beschreibung

Stumpf-Schweiß-Maschine zum Verschweißen von Rohren und Formteilen aus PE und PP von DA 63 bis 250 mm, für alle SDR-Klassen.

Merkmale

- Automatische Berechnung aller Schweißzeiten und Druckwerte.
- Automatische Regelung der Spiegeltemperatur.
- Automatische Protokollierung von bis zu 10.000 Schweißungen.
- Dateneingabe: RFID-Transponder, Manuell, Scanner (optional).
- Systemüberwachung.
- Schweißüberwachungssystem.
- Rückverfolgbarkeit nach ISO 12176-1
- Schweißnormen: DVS, WIS, SEDIGAS, UNI, NEN.
- Datenausgabe über Druckmenü
- Sprachen: DE, EN, FR, BG, CS, ZH, NL, FI, GR, IT, NO, RO, SK, TR, RU.

Spezifikationen

Stromversorgung: 230 V oder 110 V
Leistung: 3,65 kW
Arbeitsbereich: 75 – 250 mm
Gesamtgewicht: 109 kg
Herstellergarantie: 12 Monate

Lieferumfang

Transportkiste beinhaltet Schweißmaschine, Heizelement, Planhobel, Reduzierungen (75, 90, 110, 125, 140, 160, 180, 200, 225), Einstellkasten für Planhobel + Heizelement und Zubehör (Bedienungsanleitung, Werkzeug).

Description

Butt-welding machine for welding of pipes and fittings made of PE and PP from DA 63 to 250 mm, for all dimension ratios.

Features

- Automatic computation of all welding pressures and times.
- Automatic heating element temperature control.
- Automatic data logging up to 10.000 weldings.
- Data input RFID-Transponder, Manuell, Scanner (optional).
- System monitoring.
- Welding monitoring system.
- Traceability pursuant to ISO 12176-1
- Welding standards: DVS, WIS, SEDIGAS, UNI, NEN.
- Data output via print menu.
- Languages: DE, EN, FR, BG, CS, ZH, NL, FI, GR, IT, NO, RO, SK, TR, RU.

Specifications

Power supply: 230 V or 110 V
Power: 3.65 kW
Operating range: O.D. 75 – 250 mm
Total weight: 109 kg
Manufacturer warranty: 12 months

Scope of delivery

Transport case incl. welding machine, heating element, facing tool, reducers (75, 90, 110, 125, 140, 160, 180, 200, 225), carrying rack for heating element + facing tool and accessories (User's manual, tools).

Technische Änderungen vorbehalten • Specifications subject to change without notice.

Art Nr	Beschreibung • Description	VE1
Art No		PU1
9505 0030 30	HST WeldControl 2.0 - 250 Set 230 V	1
9505 0031 30	HST WeldControl 2.0 - 250 Set 110 V	1



HST-300 Manual USB 2.0

Heizwendel-Muffen-Schweißmaschine für PE- und PP-Heizwendel-Formteile bis 1200 mm
 Electrofusion socket-welding machine for PE- and PP-Electrofusion fittings up to 1200 mm

Beschreibung

Schweißmaschine für Heizwendel-Formteile aus PE/PP bis 1200 mm mit USB-Schnittstelle.

Merkmale

- Manuelle Dateneingabe von Formteilcodenummer oder Schweißspannung und Schweißzeit. Alle Dateneingaben über neuartige GT-Tastatur möglich.
- Robustes, hochauflösendes und temperaturerweitertes Display mit 5 mm Zeichenhöhe.
- Schweißüberwachungssystem (Schweißspannung, Widerstand, Schweißstrom, Kontakt, Kurzschluss, Umgebungstemperatur, Eingangsfrequenz, Eingangsspannung, Gerätetemperatur und Wartungsanzeige).
- Systemüberwachung (Systemcheck, computergesteuerter Wartungsprozess).
- USB-Schnittstelle zur Protokollierung.
- Einheitenumstellung (Inch/mm, °F/°C), Wartungsfirmen-Anzeige.
- Sprachen: DE, EN, FR, BG, CS, ZH, NL, FI, GR, IT, NO, RO, SK, TR, RU. Weitere auf Anfrage.
- 12 Monate Herstellergarantie.

Technische Daten

Ausgangsspannung: 8 - 48 V
 Ausgangsstrom: max. 110 A
 Eingangsspannung: 180 - 280 V (230 V), optional 110 V
 Eingangsfrequenz: 40 - 70 Hz
 Stromaufnahme: AC 16 A
 Temperaturbereich: -20 bis +60°C
 Netzkabel: 5 m mit Eurostecker
 Schweißkabel: 4 m mit 4,7 mm Anschlusskontakten
 Gewicht: 16 kg
 Abmessungen: B 236 x H 295 x T 330 mm

Lieferumfang

Verpackung beinhaltet Schweißmaschine, Bedienungsanleitung DE EN FR, Adapter 4,0 mm in Adaptertasche, Operator-Barcodekarte und Aluminium-Transportkiste.

Description

Welding machine for electro-fusion fittings of PE/PP up to 1200 mm with USB port.

Features

- Manual input of numeric fitting code or welding voltage and welding time; all inputs with novel GT keypad.
- Robust, high-resolution and temperature-extended screen with character size 5 mm.
- Welding monitoring system (Welding voltage, resistance, welding current, established contact, short circuit, ambient temperature, input frequency, input voltage, unit temperature, maintenance interval).
- System self monitoring (System check, computerized maintenance management).
- USB port for protocol management.
- Measurement unit selection (Inch/mm, °F/°C), Info of servicing company.
- Languages: DE, EN, FR, BG, CS, ZH, NL, FI, GR, IT, NO, RO, SK, TR, RU. Others upon request.
- 12 months manufacturer warranty.

Technical Specifications

Output Voltage: 8 - 48 V
 Output Current: max. 110 A
 Input Voltage: 180 - 280 V (230 V), optional 110 V
 Input Frequency: 40 - 70 Hz
 Rated Power: AC 16 A
 Temperature Range: -20 to +60°C
 Power Supply Cord: 5 m with Euro plug
 Welding Cable: 4 m with 4.7 mm connection terminals
 Weight: 16 kg
 Dimensions: W 236 x H 295 x T 330 mm

Scope of delivery

Packaging includes welding machine, user's manual DE EN FR, adapter 4.0 mm in adapter bag, operator bar code card and Aluminium transport box.

Technische Änderungen vorbehalten • Specifications subject to change without notice.

Art Nr	Beschreibung • Description
Art No	
9506 0001 30	HST-300 Manual USB 2.0 - 230 V
9506 0002 30	HST-300 Manual USB 2.0 - 110 V



HST-300 Junior+ 2.0

Heizwendel-Muffen-Schweißmaschine für PE- und PP-Heizwendel-Formteile bis 1200 mm
 Electrofusion socket-welding machine for PE- and PP-Electrofusion fittings up to 1200 mm

Beschreibung

Schweißmaschine für Heizwendel-Formteile aus PE/PP bis 1200 mm und Barcode-Scanner.

Merkmale

- Dateneingabe über Barcode-Scanner, optional Lesestift. Alle Dateneingaben über neuartige GT-Tastatur möglich.
- Robustes, hochauflösendes und temperaturerweitertes Display mit 5 mm Zeichenhöhe.
- Schweißüberwachungssystem (Schweißspannung, Widerstand, Schweißstrom, Kontakt, Kurzschluss, Umgebungstemperatur, Eingangsfrequenz, Eingangsspannung, Gerätetemperatur und Wartungsanzeige).
- Systemüberwachung (Systemcheck, computergesteuerter Wartungsprozess).
- ViewWeld-Funktion, Einheitenumstellung (Inch/mm, °F/°C), Wartungsfirmen-Anzeige.
- Sprachen: DE, EN, FR, BG, CS, ZH, NL, FI, GR, IT, NO, RO, SK, TR, RU. Weitere auf Anfrage.
- 12 Monate Herstellergarantie

Technische Daten

Ausgangsspannung: 8 - 48 V
 Ausgangsstrom: max. 110 A
 Eingangsspannung: 180 – 280 V (230 V), optional 110 V
 Eingangsfrequenz: 40 – 70 Hz
 Stromaufnahme: AC 16 A
 Temperaturbereich: -20 bis +60°C
 Netzkabel: 5 m mit Eurostecker
 Schweißkabel: 4 m mit 4,7 mm Anschlusskontakten
 Gewicht: 16 kg
 Abmessungen: B 236 x H 295 x T 330 mm

Lieferumfang

Verpackung beinhaltet Schweißmaschine mit Barcode-Scanner, Bedienungsanleitung DE EN FR, Adapter 4,0 mm in Adaptertasche, Operator-Barcodekarte und Aluminium-Transportkiste.

Description

Welding machine for electro-fusion fittings of PE/PP up to 1200 mm and barcode-scanner.

Features

- Data input: Bar code scanner, optionally scanning pen; all inputs with novel GT keypad.
- Robust, high-resolution and temperature-extended screen with character size 5 mm.
- Welding monitoring system (Welding voltage, resistance, welding current, established contact, short circuit, ambient temperature, input frequency, input voltage, unit temperature, maintenance interval).
- System self monitoring (System check, computerized maintenance management).
- ViewWeld feature, Measurement unit selection (Inch/mm, °F/°C), Info of servicing company.
- Languages: DE, EN, FR, BG, CS, ZH, NL, FI, GR, IT, NO, RO, SK, TR, RU. Others upon request.
- 12 months manufacturer warranty.

Technical Specifications

Output Voltage: 8 - 48 V
 Output Current: max. 110 A
 Input Voltage: 180 – 280 V (230 V), optional 110 V
 Input Frequency: 40 – 70 Hz
 Rated Power: AC 16 A
 Temperature Range: -20 to +60°C
 Power Supply Cord: 5 m with Euro plug
 Welding Cable: 4 m with 4.7 mm connection terminals
 Weight: 16 kg
 Dimensions: W 236 x H 295 x T 330 mm

Scope of delivery

Packaging includes welding machine with bar-code scanner, user's manual DE EN FR, adapter 4.0 mm in adapter bag, operator bar code card and Aluminium transport box.

Technische Änderungen vorbehalten • Specifications subject to change without notice.

Art Nr Art No	Beschreibung • Description
9506 0003 30	HST-300 Junior+ 2.0 - 230 V
9506 0004 30	HST-300 Junior+ 2.0 - 110 V

Optionen • Optional	
9506 0011 30	HST-300 Lesestift • Scanning pen



HST-300 Print+ 2.0

Heizwendel-Muffen-Schweißmaschine für PE- und PP-Heizwendel-Formteile bis 1200 mm
 Electrofusion socket-welding machine for PE- and PP-Electrofusion fittings up to 1200 mm

Beschreibung

Schweißmaschine für Heizwendel-Formteile aus PE/PP bis 1200 mm, Barcode-Scanner und automatischer Protokollierung.

Merkmale

- 10.000 Protokolle.
- Manuelle Dateneingabe von Formteilcodenummer oder Schweißspannung und Schweißzeit. Alle Dateneingaben über neuartige GT-Tastatur möglich.
- Robustes, hochauflösendes und temperaturerweitertes Display mit 8 mm Zeichenhöhe.
- Schweißüberwachungssystem (Schweißspannung, Widerstand, Schweißstrom, Kontakt, Kurzschluss, Umgebungstemperatur, Eingangsfrequenz, Eingangsspannung, Gerätetemperatur und Wartungsanzeige).
- Systemüberwachung (Systemcheck, computergesteuerter Wartungsprozess inkl. Protokollierung)
- Rückverfolgbarkeit nach ISO 12176-3/4.
- Datenausgabe über Druckmenü (USB-Schnittstelle) auf Drucker oder Stick im PDF-Format oder im DataWork-Format an den PC.
- Menügeführte Protokollansicht inkl. Suchfunktion, ViewWeld-Funktion, Speicher-Backup-Funktion, AutoWeld-Funktion, Summer-Lautstärkeregelung, Einheitenumsstellung (Inch/mm, °F/°C), Wartungsfirmen-Anzeige.
- Sprachen: DE, EN, FR, BG, CS, ZH, NL, FI, GR, IT, NO, RO, SK, TR, RU. Weitere auf Anfrage.
- 12 Monate Herstellergarantie

Technische Daten

Ausgangsspannung: 8 - 48 V
 Ausgangsstrom: max. 110 A
 Eingangsspannung: 180 – 280 V (230 V), optional 110 V
 Eingangsfrequenz: 40 – 70 Hz
 Stromaufnahme: AC 16 A
 Temperaturbereich: -20 bis +60°C
 Netzkabel: 5 m mit Eurostecker
 Schweißkabel: 4 m mit 4,7 mm Anschlusskontakten
 Gewicht: 16 kg
 Abmessungen: B 236 x H 295 x T 330 mm

Lieferumfang

Verpackung beinhaltet Schweißmaschine mit Barcode-Scanner, Bedienungsanleitung DE EN FR, Adapter 4,0 mm in Adaptertasche, Operator-Barcodekarte und Aluminium-Transportkiste.

Description

Welding machine for electro-fusion fittings of PE/PP up to 1200 mm, barcode-scanner and automatic data logging.

Features

- 10.000 reports.
- Manual input of numeric fitting code or welding voltage and welding time; all inputs with novel GT keypad.
- Robust, high-resolution and temperature-extended screen with character size 8 mm.
- Welding monitoring system (Welding voltage, resistance, welding current, established contact, short circuit, ambient temperature, input frequency, input voltage, unit temperature, maintenance interval).
- System self monitoring (System check, computerized maintenance management incl. recording).
- Traceability pursuant to ISO 12176-3/4.
- Data output via print menu (USB interface) to printer or stick in PDF-format or in DataWork format to computer.
- Intuitive report review menu incl. search, ViewWeld feature, memory backup, AutoWeld feature, buzzer volume set point, measurement unit selection (Inch/mm, °F/°C), Info of servicing company.
- Languages: DE, EN, FR, BG, CS, ZH, NL, FI, GR, IT, NO, RO, SK, TR, RU. Others upon request.
- 12 months manufacturer warranty.

Technical Specifications

Output Voltage: 8 - 48 V
 Output Current: max. 110A
 Input Voltage: 180 – 280 V (230 V), optional 110 V
 Input Frequency: 40 – 70 Hz
 Rated Power: AC 16 A
 Temperature Range: -20 to +60°C
 Power Supply Cord: 5 m with Euro plug
 Welding Cable: 4 m with 4.7 mm connection terminals
 Weight: 16 kg
 Dimensions: W 236 x H 295 x T 330 mm

Scope of delivery

Packaging includes welding machine with barcode scanner, user's manual DE EN FR, adapter 4.0 mm in adapter bag, operator bar code card and Aluminium transport box.

Technische Änderungen vorbehalten • Specifications subject to change without notice.

Art Nr Art No	Beschreibung • Description
9506 0005 30	HST-300 Print+ 2.0 - 230 V
9506 0006 30	HST-300 Print+ 2.0 - 110 V

Optionen • Optional	
9506 0011 30	HST-300 Lesestift • Scanning pen



 Handschaber
 Scraper manual

Art Nr Art No	Größe/Size	Beschreibung • Description	KG	VE1 PU1
9506 0052 30	70 mm	1-fach Klinge • 1 fold blade	0,15	1
9506 0053 30	35 mm	4-fach Klinge • 4 fold blade	0,10	1
9506 0054 30	70 mm	4-fach Klinge mit Druckknopf • 4 fold blade with push button	0,27	1

HST Rotations-Schälwerkzeuge

HST Rotating scrapers

Rotations-Schälgeräte für Rohrenden und Sattelflächen zur fachgerechten und zeit-sparender Vorbereitung des Schweißbereichs an Rohren zur Verwendung von Heizwendel-Schweiß-Formteilen.

Sicheres Entfernen der Oxidschicht auf der Oberfläche von Rohren bei geringem Kraftaufwand. Durch das federgelagerte Messer und den automatischen Vorschub erfolgt eine kontinuierliche Anpassung an Rohr-Ovalitäten und Toleranzen, wodurch ein gleichmäßiger Spanabtrag gewährleistet ist. Das hochwertige Wendemesser aus Hartmetall garantiert eine äußerst lange Standzeit.

Nach DVS 2207 ist die Verwendung von Handschabergeräten nur in Ausnahmefällen zulässig und zu begründen.

Inklusive Stahl-Transportkoffer und Werkzeug.

Rotating scrapers for pipe ends and saddle areas for professional and time efficient preparation of the welding zone of pipes for the use of electrofusion welding fittings.

Reliable removal of the oxide layer on the surface of pipes with little force. The spring-mounted blade and the automatic feed ensure continuous adaptation to pipe ovality and tolerances; whereby a constant chip removal is ensured. The high-quality turnable carbide metal knife guarantees an extremely long operating life.

According to DVS 2207, the use of hand tools is only allowed in exceptional cases and to be justified.

Inclusive steel transport box and tools.



HST Rotations-Schälwerkzeug für Sattelflächen und Rohrenden

HST Rotating scraper for saddle areas and pipe ends

Art Nr Art No	DA/OD [mm]	Beschreibung • Description	KG	VE1 PU1
9506 0066 30	63 - 180	Größe • Size - 2 / 180	10,0	1
9506 0067 30		Ersatzmesser für Größe • Replacement knife for size - 2	0,01	1

HST Rotations-Schälwerkzeug für Rohrenden

HST Rotating scraper for pipe ends



Art Nr Art No	DA/OD [mm]	Beschreibung • Description	KG	VE1 PU1
9506 0060 30	32 - 160	Größe • Size - 1 / 160	4,50	1
9506 0061 30	63 - 250	Größe • Size - 1.5 / 250	9,00	1
9506 0062 30	110 - 500	Größe • Size - 2 / 500	10,0	1
9506 0063 30	560 - 1000	Größe • Size - 3 / 1000		1
9506 0064 30		Ersatzmesser für Größe • Replacement knife for size - 1, 1.5, 2	0,10	1
9506 0065 30		Ersatzmesser für Größe • Replacement knife for size - 3	0,10	1



Art Nr Art No	D [mm]	Beschreibung	Description	KG	VE1 PU1
9506 0080 30	20-75	HST Universal Haltevorrichtung 75, D 20 - 75 mm inkl. Tragetasche, L 610 x B 225 x H 115 mm	HST All-purpose Pipe Aligner 75, D 20 - 75 mm incl. transport bag, L 610 x W 225 x H 115 mm	4,50	1
9506 0081 30	75-180	HST Universal Haltevorrichtung 180, D 75 - 180 mm inkl. Transport-Box, L 980 x B 430 x H 260 mm	HST All-purpose Pipe Aligner 180, D 75 - 180 mm incl. transport box, L 980 x W 430 x H 260 mm	16,40	1
9506 0082 30	125-500	HST Universal Haltevorrichtung 500, D 125 - 500 mm inkl. Transport-Box	HST All-purpose Pipe Aligner 500, D 125 - 500 mm incl. transport box	47,50	1

HST Rundungsschalen + Rundungsschellen

Für das Runden von Rohren beim Verschweißen von Heizwendel-Schweiß-Formteilen. Auch verwendbar für andere Schweißverfahren.

Rounding shell + Rounding clamp

For rounding of pipes during the welding of electrofusion welding fittings. Also useable for other welding technics.



HST Rundungsschelle RSH, Stahl, Oberfläche verzinkt, ohne Hydraulikzylinder
HST Rounding clamp RSH, steel, surface galvanized, without hydraulic cylinder

Art Nr Art No	DA/OD [mm]	KG	VE1 PU1
9506 0101 30	250	15,70	1
9506 0102 30	280	16,80	1
9506 0103 30	315	17,90	1
9506 0104 30	355	19,9	1
9506 0105 30	400	25,4	1
9506 0106 30	450	26,9	1
9506 0107 30	500	28,5	1
9506 0108 30	560	32,9	1
9506 0109 30	630	36,9	1
9506 0110 30	710	38,6	1
9506 0111 30	800	43,4	1

HST Hydraulikzylinder für Rundungsschelle RSH
HST Hydraulic cylinder for rounding clamp RSH

9506 0112 30	250 - 800	15,4	1
--------------	-----------	------	---



HST Rundungsschalen, verzinkt, mit 4 Schrauben + Langmuttern
HST Rounding shell, galvanized, with 4 screws + long nuts

Art Nr Art No	DA/OD [mm]	KG	VE1 PU1
9506 0090 30	63	4,0	1
9506 0091 30	75	4,5	1
9506 0092 30	90	5,0	1
9506 0093 30	110	7,0	1
9506 0094 30	125	8,0	1
9506 0095 30	140	9,0	1
9506 0096 30	160	11,0	1
9506 0097 30	180	12,0	1
9506 0098 30	200	13,0	1
9506 0099 30	225	15,0	1
9506 0100 30	250	18,0	1



Bohrer Einschweißsattel

Driller weld-in-saddle

Art Nr	d	KG	VE1
Art No	[mm]		PU1
9507 07B0 09	25	0,15	1
9507 08B0 09	32	0,22	1
9507 09B0 09	40	0,23	1
9507 10B0 09	50	0,33	1
9507 11B0 09	63	0,45	1



Schweißwerkzeug Einschweißsattel Teflon-beschichtet

Welding tool weld-in-saddle Teflon-coated

Nr	Art Nr	d x d2	KG	VE1
No	Art No	[mm]		PU1
①	9507 0907 09	40-63 x 25	0,24	1
②	9507 0908 09	40-63 x 32	0,25	1
③	9507 1207 09	75-125 x 25	0,28	1
④	9507 1208 09	75-125 x 32	0,41	1
⑤	9507 1209 09	75-125 x 40	0,36	1
⑥	9507 1410 09	75-125 x 50	0,65	1
⑦	9507 1511 09	75-125 x 63	1,05	1
⑧	9507 1707 09	160-250 x 25	0,17	1
⑨	9507 1708 09	160-250 x 32	0,23	1
⑩	9507 1709 09	160-250 x 40	0,36	1
⑪	9507 1710 09	160-250 x 50	0,65	1
⑫	9507 1711 09	160-250 x 63	1,04	1
⑬	9507 2307 09	315-630 x 25	0,15	1
⑭	9507 2308 09	315-630 x 32	0,20	1
⑮	9507 2309 09	315-630 x 40	0,35	1
⑯	9507 2310 09	315-630 x 50	0,65	1
⑰	9507 2311 09	315-630 x 63	1,10	1

HORNET™

Polypropylen Abgangs-Herstellung-Werkzeug für Abgänge von 20 bis 63 mm auf 40 bis 630 mm Leitungsdurchmesser.

HORNET™

Polypropylene outlet fusion tool for branch sizes 20 to 63 mm on to 40 to 630 mm main sizes.

Beschreibung

Der HORNET - ein neues Universal-Werkzeug für die Polypropylen-Einschweißsättel - ist eine Neuheit. Es bringt eine innovative Alternative zu manuellen Methoden von Abgängen, die produktiver, effizienter und zuverlässiger als je zuvor ist. Das patentrechtlich geschützte Design der HORNET ermöglicht es, sich auf der Mitte des Rohres selbst auszurichten, während ein geführter Schlitten das Bohren des Auslasslochs und die Einführung des Sattels erleichtert - alles perfekt ausgerichtet hält, ohne die Maschine neu zu positionieren.

Die einzigartigen Schnellwechselbohrer- und Befestigungsadapter von HORNET im Schlitten sind leicht wechselbar, so dass das Auslassloch und die Ausrichtung des Sattels während des gesamten Prozesses überein stimmt und so eine genauere Verbindung entsteht.

Mit einer kleinen Stellfläche und einem Gewicht von nur 6,9 kg ist der HORNET in der Lage, in jeder Orientierung zu arbeiten - ideal für Über-Kopf und vertikale Verbindungen in engen Räumen. Der HORNET arbeitet mit allen vorhandenen Heizelementen und Einschweißsätteln für Polypropylen-Rohr. Ein integrierter Ratschenriemen ermöglicht es, den HORNET an einer breiten Palette von Rohr-Dimensionen von 40 bis 630 mm zu befestigen, während die Einschweiß-Sättel für 20 mm bis 63 mm Abgänge installiert werden.

Merkmale

- Eloxierte Aluminium-Verschleißflächen für Korrosionsbeständigkeit
- Schnellwechselbohrer und passender Adapter für effiziente Verbindungen
- Zahnstangenantrieb für leichtgängigen Betrieb
- Selbstzentrierende Grundkonstruktion sorgt dafür, dass die Verbindungsvorgänge auf der Rohrmitte ausgerichtet sind
- Integrierter Ratschenriemen ermöglicht den Betrieb über ein breites Spektrum an Rohrgrößen
- Leicht und kompakt
- Arretierung des Schlittens in Position

Spezifikationen

Abgangsgröße: 20 - 63 mm
 Hauptrohrgröße: 40 - 630 mm
 Maschinengewicht: 6,9 kg (15.3 lbs.)
 Maximale Hublänge: 206 mm (8 Zoll)

Lieferumfang

Verpackung beinhaltet Hornet Maschine, Bohrer und Montageadapter, Ratschenriemen, Zubehörkoffer und Tragekoffer.
 Bohrer nicht inbegriffen. Schneider, Heizelement- und Schweiß-Werkzeuge sind separat erhältlich.

Description

The HORNET — a new all-in-one tool for polypropylene outlet fusion — is an industry first. It brings an innovative alternative to manual outlet fusion methods that is more productive, efficient and reliable than ever before. The Hornet's patent-pending design allows it to self-align on the center of the pipe while a guided carriage facilitates the drilling of the outlet hole and fusion of the fitting — keeping everything perfectly aligned without repositioning the machine.

The HORNET's unique quick-change drill and fitting adapters easily swap in and out of the carriage which keeps the outlet hole and fitting aligned throughout the entire process — creating a more accurate fusion.

With a small footprint and weighing just 14 pounds, the HORNET is capable of performing in any orientation — making it ideal for overhead and vertical fusions in tight spaces. The HORNET works with all existing socket heaters and fusion outlet welding heads for polypropylene pipe. An integrated ratchet strap allows it to attach to a wide range of main sizes from 40mm to 630 mm while installing outlets for 20 mm to 63 mm branches.

Features

- Anodized aluminium wear surfaces for corrosion resistance
- Quick-change drill and fitting adapter for efficient fusions
- Rack and pinion drive for smooth operation
- Self-centering base design ensures fusion operations align on center of pipe
- Integrated ratchet strap allows operation across wide range of pipe sizes
- Light weight and compact
- Carriage locks in position

Specifications

Branch Size: 20 – 63 mm
 Main Size: 40 – 630 mm
 Machine Weight: 6.9 kg (15.3 lbs.)
 Maximum Stroke Length: 206 mm (8 inch)

Scope of delivery

Packaging includes HORNET fusion machine, drill and fitting adapters, ratchet strap, accessory case and carrying case.
 Drill not included. Cutters, heater and heater adapters sold separately.

Technische Änderungen vorbehalten • Specifications subject to change without notice.

Teil / Item **9507 0001 30**

Art Nr	Beschreibung	Description	VE1
Art No			PU1
9507 001 30	McELROY HORNET	McELROY HORNET	1

Z.05.08 Schälwerkzeuge Stabitec • Peeling tools Stabitec



Kombi-Schälgerät STABITEC *
Combi peeling tool STABITEC *

Art Nr	d	KG	VE1
Art No	[mm]		PU1
9508 0506 09	16 + 20	0,32	1
9508 0607 09	20 + 25	0,30	1
9508 0809 09	32 + 40	0,44	1
9508 1011 09	50 + 63	1,12	1



Schälgerät STABITEC *
Peeling tool STABITEC *

Art Nr	d	KG	VE1
Art No	[mm]		PU1
9508 1200 09	75	1,27	1
9508 1300 09	90	1,33	1
9508 1400 09	110	1,72	1
9508 1500 09	125	2,50	1



Anfaswerkzeug Einschweißsattel STABITEC
Chamfering tool weld-in-saddle STABITEC

Art Nr	d	KG	VE1
Art No	[mm]		PU1
9508 07A0 09	25	0,31	1

* Achtung: Schälentiefe für Muffen-Schweißen.
Attention: Peeling depth for socket-welding.



Ersatzklinge für Schälgeräte STABITEC
Replacement blade for peeling tools STABITEC

Art Nr	KG	VE1
Art No		PU1
9508 0001 09	0,010	1

Z.05.09 Reparatursets • Repair sets



Art Nr	Beschreibung	Description	KG	VE1
Art No				PU1
9509 0001 09	Reparatur-Set Lochstopfen D7 für Bohrlöcher bis 6 mm	Repair set hole plug D7 for drill holes up to 6 mm	0,15	1
9509 0002 09	Reparatur-Set Lochstopfen D11 für Bohrlöcher bis 10 mm	Repair set hole plug D11 for drill holes up to 10 mm	0,15	1
9509 0003 01	Lochstopfen grün D7 für Bohrlöcher bis 6 mm	Hole plug green D7 for drill holes up to 6 mm	0,01	1
9509 0004 01	Lochstopfen grün D11 für Bohrlöcher bis 10 mm	Hole plug green D11 for drill holes up to 10 mm	0,01	1



TESTO 925 Set

Temperatur-Messgerät (1-Kanal) mit Fühler.

Temperature measuring instrument (1-channel) with sensor.

Beschreibung

Das TESTO 925 ist ein 1-Kanal-Temperatur-Messgerät, welches insbesondere für den Einsatz im HVAC-Bereich geeignet ist. Das Gerät ist optimal für den Anschluss von schnellen und zuverlässigen Thermoelement-Fühlern geeignet. Das Gerät zeigt fortlaufend zuverlässig die Minimal- und Maximalwerte an. Es können Grenzwerte hinterlegt werden und es ertönt ein akustisches Warnsignal, wenn die Werte unter- oder überschritten werden.

Das Gerät eignet sich somit optimal zur Überprüfung der Temperaturen an Heizelementen.

Optional: Funkfühler und Protokolldrucker.

Technische Daten

- Sensortyp: K (NiCr-Ni)
- Messbereich Sensor: -50 - +1000°C
- Auflösung: 0,1 °C (-50 - +199,9°C)
- Betriebstemperatur: -20 - +50°C
- Lagertemperatur: -40 - +70°C
- Batterietyp: 9V-Block, 6F22
- Standzeit: bis zu 200 h
- Abmessung: 182 x 64 x 40 mm
- Gewicht: 171 g
- Herstellergarantie: 2 Jahre

Lieferumfang

Verpackung beinhaltet Messgerät und Sensor.

Description

The TESTO 925 is a 1-channel temperature measuring instrument, which is particularly suitable for use in the HVAC range. The device is perfect for the connection of fast and reliable thermoelement sensors. The device constantly displays the minimum and maximum values reliably. Limits can be stored and an acoustic warning signal sounds when the values are below or exceeded.

The device is therefore ideally suited for checking the temperatures at heating elements.

Optional: wireless sensor and protocol printer.

Features

- Type of sensor: K (NiCr-Ni)
- Measuring range sensor: -50 - +1000°C
- Resolution: 0.1 °C (-50 to +199.9°C)
- Operating temperature: -20 - +50°C
- Storage temperature: -40 - +70°C
- Battery type: 9V block, 6F22
- Working time: up to 200 h
- Dimension: 182 x 64 x 40 mm
- Weight: 171 g
- Manufacturing guarantee: 2 years

Scope of delivery

Packaging includes measuring instrument and sensor.

Technische Änderungen vorbehalten • Specifications subject to change without notice.

Art Nr	Beschreibung	Description	VE1
Art No			PU1
9510 0001 30	TESTO 925 Set	TESTO 925 set	1



Art Nr	G	Beschreibung	Description	KG	VE1
Art No	[Inch]				PU1
9901 0001 39	3/4	MS-Druckminderer PN16 AG Druck einstellbar von 1,5 bis 5,5 bar, für flachdichtende Anschlussver- schraubungen, Anschlussmöglichkeit für Manometer.	Brass-Pressure reducer PN16 male-thread pressure adjustable from 1,5 to 5,5 bar, for flat sealing connection unions, connection for pressure gauge.	0,35	1



Art Nr	G	Beschreibung	Description	KG	VE1
Art No	[Inch]				PU1
9901 0002 30	1/4	Manometer 0 - 10 bar (0 - 145 PSI) AG für Druckminderer	Pressure Gauge 0 - 10 bar (0 - 145 PSI) male-thread for pressure reducer	0,19	1



Art Nr	G	Beschreibung	Description	KG	VE1
Art No	[Inch]				PU1
9901 0003 39	3/4	Ms Rückschlagventil PN16 IG	Brass Non-return valve PN16 female-thread	0,17	1







A Anhang • Appendix

- A1 Zeichenerklärung • Legend
- A2 Rechtliche Hinweise • Legal notice
- A3 Verkaufsbedingungen • Conditions of sale



A1 Zeichenerklärung • Legend

Werkstoffe • Materials

	Deutsch	English
CFR	PP-RCT mit Flammschutzmittel; alpha-nukleiert.	PP-RCT flame resistant; alpha-nucleated.
EPDM	Ethylen-Propylen-Kautschuk	nitrile rubber
FCKW	Fluorchlorkohlenwasserstoffe	Chlorofluorocarbon
FKM (FPM)	Fluor-Kautschuk	fluor rubber
GGG	Grauguß globular	cast iron globular
GJMW (GTW)	Temperguss	malleable iron
LFB	Messing Bleifrei	Leadfree Brass
Ms	Messing	brass
NBR	Nitril-Kautschuk	nitrile rubber
PB	Polybuthylen	Polybutylene
PE	Polyethylen	Polyethylene
PE100	PE-Festigkeitsklasse nach ISO 9080	PE strength class according ISO 9080
PE-HD	PE-Hohe Dichte	PE-High density
PP	Polypropylen	Polypropylene
PP-R	Polypropylen – Random copolymer (alpha-nukleiert).	Polypropylene - Random copolymer (alpha-nucleated).
PP-RCT	PP-R mit modifizierter Kristallstruktur (beta-nukleiert) und erhöhter Temperaturbeständigkeit.	PP-R with modified crystalline structure (beta-nucleated) and increased temperature resistance.
PTFE	Polytetrafluorethylen	Polytetrafluorethylene
PVC	Polyvinylchlorid	Polyvinylchloride
PVC-U	Weichmacherfreies PVC (hart)	unplasticized PVC
RG	Rotguss	bronze
St	Stahl	steel
V2A	Nicht rostender Stahl (Edelstahl)	stainless steel

Normen, Richtlinien • Standards, guidelines

	Deutsch	English
ANSI	Amerikanische Organisation zur Koordinierung der Entwicklung freiwilliger Normen	American National Standard Institute
DIN	Deutsches Institut für Normung	German institute for standards
DIN Certco	Zertifizierungsorganisation des DIN	Certification organization of DIN
DVGW	Deutscher Verein des Gas- und Wasserfaches	German association for gas and water profession
DVS	Deutscher Verband für Schweißen	German welding association
EN	Europäische Norm	European standard
GW	Arbeitsblatt des DVGW	Working sheet of DVGW
ISO	Internationale Organisation für Normung	International Standardisation Organisation
KTW	Kunststoffe in Kontakt mit Trinkwasser	Plastics in drinking water
MRS	Erforderliche Mindestfestigkeit	minimum required strength
NSF	Nationale Wissenschafts Stiftung	National Science Foundation
RAL	Deutsches Institut für Gütesicherung und Kennzeichnung	German institute for quality control and labeling
TÜV	Technischer Überwachungsverein	Association for Technical Inspection
WRAS	Britisches Konformitätszeichen im Wasserbereich	Water Regulations Advisory Scheme
ZP	DIN Certco Richtlinie	DIN Certco guideline

Maße, Dimensionen • Measures, dimensions

	Deutsch	English
B, b	Breite	width
C	Flanschstärke	flange thickness
D, Da	Außendurchmesser	outside diameter
d, Di	Innendurchmesser	inside diameter
DK	Lochkreisdurchmesser	hole circle diameter
DL	Lochdurchmesser	hole diameter
DN	Nenndurchmesser	Diameter Nominal
e	Wandstärke	wall thickness
H, h	Höhe	height
i-a / f-m	Innen-außen	inside-outside / female-male
kg	Kilogramm	kilogram
L, l	Länge	length
lbs	Amerikanische Gewichtseinheit (Pfund)	American weight unit (pound)
m	Meter	meter
mm	Millimeter	millimeter
mPa	Mega Pascal (Druckeinheit)	mega Pascal (pressure unit)
nL	Anzahl Löcher	number of holes
P	Druck	pressure
PN	Nenndruck	Pressure Nominal
r	Radius	radius
S	Rohrserie (S-Klasse)	pipe series (S-class)
SDR	Rohrkennzahl	Standard Dimension Ratio
SF	Sicherheitsfaktor	safety factor
SW	Schlüsselweite	wrench size
T, t	Tiefe	depth
W/mK	Einheit der Wärmeleitfähigkeit	Unit of thermal conductivity
Z, z	z-Maß	z-dimension
°	Grad	degrees
°C	Grad Celsius (Temperatur)	degrees Celsius (temperature)
[]	Einheit	unit

Gewinde • Thread

	Deutsch	English
AG / m	Außengewinde	outside thread / male
G	Gewinde – zylindrisch Nicht im Gewinde dichtend	thread – cylindrical not tightening
IG / fem	Innengewinde	inside thread / female
keg / con	Kegelig (konisch)	conical
NPT	Rohr außen-, -innengewinde - kegelig	pipe outside/inside thread, conical
R	Rohr außen- und innengewinde – kegelig, im Gewinde dichtend	pipe thread male – conical, tightening
Rc	Rohr innengewinde – kegelig, im Gewinde dichtend	pipe thread female – conical, tightening
Rp	Rohr innengewinde – zylindrisch, im Gewinde dichtend	pipe thread female – cylindrical, tightening
zyl, cyl	zylindrisch	cylindrical

Abkürzungen • Abbreviations

	Deutsch	English
BB	Bundbuchse	flange adaptor socket
KL	Klappe	(shut-)valve
red	reduziert	reduced
™	Warenzeichen	Trademark
UP	Unterputz	concealed
UV	Ultraviolett	ultraviolet
Ü-	Übergangs-	transition
VB	Vorschweißbund	flange adaptor spigot
VE/PU	Verpackungseinheit	packaging unit
©	Urheberrecht	Copyright
®	Eingetragenes Warenzeichen	registered Trademark



Rechtliche Hinweise

Mit Erscheinen dieses Drucks verlieren frühere Ausgaben ihre Gültigkeit. Die maßgebliche Version dieser Publikation finden Sie auf unserer Webseite www.baenninger.de.

Alle Angaben in diesem Katalog entsprechen dem heutigen Stand unserer Kenntnisse und sollen über unsere Produkte und mögliche Anwendungen informieren (Irrtümer, Änderungen und Druckfehler vorbehalten). Sie haben somit nicht die Bedeutung, bestimmte Eigenschaften der Produkte oder deren Eignung für einen konkreten Einsatzzweck rechtlich verbindlich zuzusichern.

Für Anwendungen, Verwendungen, Verarbeitungen oder den sonstigen Gebrauch dieser Informationen oder unserer Produkte, sowie die sich daraus ergebenden Folgen, übernehmen wir keine Haftung.

Der Käufer ist verpflichtet, die Qualität sowie die Eigenschaften der Produkte zu kontrollieren; er übernimmt die volle Verantwortung für Auswahl, Anwendung, Verwendung und Verarbeitung der Produkte und den Gebrauch der Informationen sowie die Folgen daraus. Etwa bestehende Schutzrechte Dritter sind zu berücksichtigen.

Eigentums- und Urheberrechte an sämtlichen Zeichnungen und Tabellen bleiben ausdrücklich vorbehalten. Wiedergabe jedweder Art – auch auszugsweise – nur nach vorheriger schriftlicher Genehmigung und mit Quellenangabe.

© Bänninger Kunststoff-Produkte GmbH, Reiskirchen.

Legal notice

Upon publication of this document all previous editions shall become void. The authoritative version of this publication can be found on our website at www.baenninger.de.

All information furnished herein reflects our scope of knowledge at the point of publication and is designed to provide details of our products and potential fields of application (errors, changes and omissions excepted, including typographical mistakes). The furnishing of such information shall not be deemed as constituting the provision of legally binding guarantees as to specific product-related properties of their suitability for specific areas of application.

We shall assume no liability for the application, utilisation, processing or other use of this information or of our products. Furthermore, we shall assume no liability for any consequences related thereto.

The purchaser is obliged to examine the quality and properties of these products; he shall be responsible in full for selecting, applying, utilising and processing said products as well as applying any information relating thereto, which shall also include all consequences associated with such actions. Third-party property rights shall be observed accordingly.

Ownership and copyrights of all drawings and tables are expressly reserved. Reproduction of any kind - also preferably - only with prior written permission and with source indication.

© by Bänninger Kunststoff-Produkte GmbH, Reiskirchen.

§ 1 Geltungsbereich

- (1) Die Leistungen und Angebote der Bänninger Kunststoff-Produkte GmbH (nachfolgend: Lieferer genannt) erfolgen ausschließlich aufgrund dieser Verkaufs- und Lieferbedingungen. Diese gelten auch für alle zukünftigen Geschäfte mit dem Vertragspartner (nachfolgend: Besteller genannt), selbst wenn sie nicht nochmals ausdrücklich vereinbart werden. Entgegenstehende oder von diesen Verkaufs- und Lieferbedingungen abweichende Allgemeine Geschäftsbedingungen des Bestellers erkennt der Lieferer nicht an, es sei denn, der Lieferer hätte ausdrücklich schriftlich ihrer Geltung zugestimmt.
- (2) Sämtliche Vereinbarungen, die zwischen dem Lieferer und dem Besteller zwecks Ausführung des Vertrages getroffen werden, sind in diesem Vertrag schriftlich niederzulegen. Zusätzliche mündliche Vereinbarungen wurden zwischen Lieferer und Besteller nicht getroffen.
- (3) Diese Verkaufs- und Lieferbedingungen gelten spätestens mit der Entgegennahme der Ware oder Leistung durch den Besteller als angenommen.
- (4) Diese Verkaufs- und Lieferbedingungen gelten nur gegenüber Unternehmen im Sinne von § 310 BGB.

§ 2 Angebot, Vertragsabschluss und Garantie

- (1) Die Angebote des Lieferers sind stets freibleibend. Annahmeerklärungen und sämtliche Bestellungen bedürfen zu ihrer Rechtswirksamkeit der schriftlichen Bestätigung des Lieferers. Sofern die Übersendung einer Auftragsbestätigung durch den Lieferer unterbleibt, kommt der Vertrag gleichwohl zustande, wenn der Lieferer aufgrund der Bestellung ausliefert und der Besteller die Ware abnimmt.
- (2) Zeichnungen, Abbildungen, Maße, Gewichte oder sonstige Leistungsdaten in Tabellen, Werbeprospekten, Katalogen oder ähnlichem des Lieferers, sind nur verbindlich, wenn dies ausdrücklich und schriftlich vereinbart wird.
- (3) Eine Garantie gilt nur dann als vom Lieferer übernommen, wenn dieser schriftlich die jeweilige Eigenschaft als „garantiert“ bezeichnet hat.

§ 3 Lieferfristen und Leistungszeit

- (1) Verbindliche Lieferzeiten müssen ausdrücklich und schriftlich als solche vereinbart werden. Bei sämtlichen sonstigen Lieferterminen handelt es sich lediglich um unverbindliche oder ungefähre Liefertermine und Lieferfristen, bei denen sich der Lieferer bemüht, diese einzuhalten.
- (2) Lieferfristen beginnen mit dem Tag der Absendung der Auftragsbestätigung durch den Lieferer, jedoch nicht, bevor alle Einzelheiten der Ausführung der Lieferung geklärt sind und sämtliche vom Besteller zu erfüllenden Voraussetzungen vorliegen. Sofern der Besteller nach Auftragserteilung Änderungen verlangt, beginnt eine neue Lieferzeit erst mit der Bestätigung der Änderung durch den Lieferer.
- (3) Lieferungen vor Ablauf der Lieferzeit sind zulässig. Bei sofortiger Lieferung der Ware kann auf die Absendung einer Auftragsbestätigung verzichtet werden. Die Bestätigung kann in diesem Fall durch einen Lieferschein ersetzt werden.
- (4) Als Liefertag gilt der Tag der Meldung der Versandbereitschaft, andernfalls der Tag der Absendung der Ware. Auf Abruf bestellte Lieferungen sind innerhalb von sechs Monaten nach Auftragsbestätigung abzunehmen.
- (5) Der Lieferer ist zu Teillieferungen berechtigt. Jede Teillieferung gilt als selbständiges Geschäft.
- (6) Sofern der Lieferer in Lieferverzug gerät, muss der Besteller dem Lieferer zunächst eine angemessene Nachfrist zur Leistung setzen. Sofern diese Frist fruchtlos verstreicht, kann der Besteller unter den jeweiligen Voraussetzungen der §§ 280, 281, 284, 286, 323 BGB die dort geregelten Rechte geltend machen.
- (7) Erhält der Lieferer aus von ihm nicht zu vertretenden Gründen Lieferungen oder Leistungen seines Vorlieferanten nicht, nicht richtig oder nicht rechtzeitig oder treten Ereignisse höherer Gewalt ein, so wird der Lieferer den Besteller darüber rechtzeitig schriftlich informieren. In diesem Fall verlängert sich die Frist um die Dauer der Behinderung. Der höheren Gewalt stehen gleich: Arbeitskämpfe, behördliche Eingriffe, Energie- und Rohstoffknappheit, unverschuldete Transportengpässe, unverschuldete Betriebsbehinderungen wie beispielsweise durch Feuer, Wasser und Maschinenschäden und alle sonstigen Behinderungen, die bei objektiver Betrachtungsweise nicht vom Lieferer schuldhaft herbeigeführt worden sind. Ist ein Liefertermin oder eine Lieferfrist verbindlich vereinbart und wird aufgrund von verschiedenen Ereignissen der vereinbarte Liefertermin oder die vereinbarte Lieferzeit um mehr als zwei Monate überschritten, so ist der Besteller berechtigt, wegen des noch nicht erfüllten Teil vom Vertrag zurückzutreten.

§ 4 Versand und Gefahrübergang

- (1) Soweit nichts Abweichendes schriftlich vereinbart ist, erfolgt der Versand unversichert auf Gefahr und zu Lasten des Bestellers. Die Wahl des Transportweges und des Transportmittels bleibt dem Lieferer vorbehalten. Die Gefahr des zufälligen Untergangs oder der zufälligen Verschlechterung der Ware geht mit Übergabe der zu liefernden Ware an den Besteller, den Spediteur, den Frachtführer oder die sonst zur Ausführung der Versendung bestimmten Unternehmungen, spätestens mit Verlassen der Ware des Werkes/des Lagers des Lieferers auf den Besteller über.
- (2) Sofern sich die Sendung der Ware dadurch verzögert, dass der Lieferer in Folge gänzlicher oder teilweiser Zahlungsverzuges des Bestellers von seinem Zurückbehaltungsrecht Gebrauch macht, oder aus einem sonstigen vom Besteller zu vertretenden Grund, geht die Gefahr spätestens ab Datum der Mitteilung der Versandbereitschaft auf den Besteller über.
- (3) Versandfertig gemeldete Ware muss unverzüglich abgerufen werden. Andernfalls ist der Lieferer berechtigt, sie nach seiner Wahl zu versenden oder auf Kosten und Gefahr des Bestellers zu lagern.
- (4) Verleaganleitungen der gelieferten Ware können auf der Homepage des Lieferers unter: www.baenninger.de abgerufen werden. Sofern der Besteller die Aushändigung einer Verleaganleitung wünscht, hat er dies dem Lieferer mitzuteilen. Der Lieferer trägt in diesem Fall dafür Sorge, dass der Besteller eine technische Verleaganleitung erhält.

§ 5 Preise und Zahlungsbedingungen

- (1) Die Rechnungen des Lieferers sind zahlbar innerhalb von 30 Tagen ab Rechnungsdatum ohne Abzug. Bei Zahlungen innerhalb von 10 Tagen werden, soweit der Besteller nicht mit der Begleichung von Warenforderungen in Verzug ist, 3 % Skonto gewährt. Maßgeblich ist der Tag der Gutschrift auf dem Konto des Lieferers. Mit Eintritt des Verzuges des Bestellers werden Fälligkeitszinsen in Höhe von 8 % über dem jeweiligen Basiszinssatz berechnet.
- (2) Vom Besteller angebotene Wechsel werden vom Lieferer nur erfüllungshalber sowie nach ausdrücklicher Vereinbarung und unter Voraussetzung ihrer Diskontierbarkeit akzeptiert. Diskontospesen werden vom Tage der Fälligkeit des Rechnungsbetrages an seitens des Lieferers berechnet. Bei Wechseln und Schecks gilt der Tag ihrer Einlösung als Zahltag.
- (3) Werden Zahlungsbedingungen durch den Besteller nicht eingehalten oder Umstände bekannt, die nach Ausübung des pflichtgemäßen kaufmännischen Ermessens des Lieferers begründete Zweifel an der Kreditwürdigkeit des Bestellers entstehen lassen, und zwar auch solche Tatsachen, die schon bei Vertragsabschluss vorliegen, dem Lieferer jedoch nicht bekannt waren oder bekannt sein müssten, so ist der Lieferer unbeschadet weitergehender gesetzlicher Rechte berechtigt, die Weiterarbeit an laufenden Verträgen oder die Belieferung einzustellen und für noch ausstehende Lieferungen, Vorauszahlungen oder Stellungen von entsprechenden Sicherheiten zu verlangen, und nach erfolglosem Verstreichen einer angemessenen Nachfrist für die Leistung von solchen Sicherheiten – unbeschadet weiterer gesetzlicher Rechte – vom Vertrag zurückzutreten. Der Besteller ist verpflichtet, dem Lieferer sämtliche durch die Nichtausführung des Vertrages entstehende Schäden zu ersetzen.
- (4) Die Möglichkeit der Aufrechnung steht dem Besteller nur dann zu, wenn seine Gegenansprüche rechtskräftig festgestellt, unbestritten oder von dem Lieferer anerkannt sind. Außerdem ist der Besteller zur Ausübung eines Zurückbehaltungsrechts nur dann befugt, wenn sein Gegenanspruch auf dem gleichen Vertragsverhältnis beruht.

- (5) Sofern sich aus der Auftragsbestätigung nichts anderes ergibt, gelten die Preise des Lieferers, die sich grundsätzlich in Euro verstehen, EXW (ab Werk/Lager) zzgl. MwSt. in der jeweiligen gesetzlichen Höhe. Die Preise schließen Verpackungen, Fracht, Porto und Versicherung nicht mit ein. Diese werden gesondert in Rechnung gestellt.
- (6) Bei Eintritt einer wesentlichen Änderung der Kostenfaktoren, wie im Falle der Erhöhung von Materialbeschaffungskosten, Lohn und Lohnnebenkosten sowie Energiekosten ist der Lieferer berechtigt, den Preis einseitig angemessen zu erhöhen, wenn zwischen dem Vertragsabschluss mit dem Besteller und Lieferung der Ware vier Monate liegen.
- (7) Abnahmeprüfzeugnisse nach DIN EN 10204-3.1 B werden mit € 25,- Bearbeitungsgebühr berechnet.

§ 6 Eigentumsvorbehalt

- (1) Der Lieferer behält sich das Eigentum an der gelieferten Ware (nachfolgend „Kaufsache“) vor, bis alle Forderungen des Lieferers aus der Geschäftsverbindung mit dem Besteller beglichen sind.
- (2) Der Besteller hat die Kaufsache auf eigene Kosten ausreichend, insbesondere gegen Feuer und Diebstahl zum Neuwert zu versichern.
- (3) Der Besteller ist berechtigt, die Kaufsache im gewöhnlichem Geschäftsverkehr weiter zu verkaufen. Andere Verfügungen, insbesondere Verpfändungen oder Einräumung von Sicherungseigentum, sind ihm nicht gestattet.
- (4) Wird die Kaufsache bei Weiterveräußerung vom Dritterwerber nicht sofort vollständig bezahlt, ist der Besteller verpflichtet, nur unter Eigentumsvorbehalt an den Dritterwerber weiter zu veräußern.
- (5) Die Berechtigung zur Weiterveräußerung der Kaufsache entfällt, wenn der Besteller seine Zahlung einstellt oder gegenüber dem Lieferer in Zahlungsverzug gerät.
- (6) Der Besteller tritt bereits jetzt an den Lieferer alle Forderungen einschließlich Sicherheiten und Nebenrechte in Höhe des mit dem Lieferer vereinbarten Faktura-Endbetrages einschließlich Mehrwertsteuer ab, die dem Besteller aus der Weiterveräußerung der Kaufsache gegen seinen Abnehmer oder Dritten erwachsen und zwar unabhängig davon, ob die Kaufsache ohne oder nach Verarbeitung weiterverkauft worden ist.
- (7) Bei Pfändungen oder sonstigen Eingriffen Dritter hat der Besteller den Lieferer unverzüglich schriftlich unter Übergabe etwaiger Unterlagen zu benachrichtigen, damit der Lieferer Schutzklagen erheben kann.
- (8) Eine etwaige Verarbeitung oder Umbildung der Kaufsache wird stets für den Lieferer vorgenommen. Wird die Kaufsache mit anderen, nicht dem Lieferer gehörenden Gegenständen verarbeitet, so erwirbt der Lieferer das Miteigentum an der neuen Sache im Verhältnis des Rechnungswertes der Kaufsache zu den anderen verarbeiteten Gegenständen zum Zeitpunkt der Verarbeitung. Für die durch Verarbeitung entstehenden Sachen gilt im Übrigen das Gleiche wie für die unter Vorbehalt gelieferte Kaufsache. Wird die Kaufsache mit anderen, dem Lieferer nicht gehörenden Gegenständen trennbar vermischt, so erwirbt der Lieferer das Miteigentum an der neuen Sache im Verhältnis des Rechnungswertes der Kaufsache zu den anderen vermischten Gegenständen zum Zeitpunkt der Vermischung. Erfolgt die Vermischung in der Weise, dass die Sache des Bestellers als Hauptsache anzusehen ist, so gilt als vereinbart, dass der Besteller dem Lieferer anteilmäßig Miteigentum überträgt. Der Besteller verwahrt das so entstandene Alleineigentum oder Miteigentum für den Lieferer.
- (9) Der Besteller tritt an den Lieferer auch die Forderungen zur Sicherung der Forderungen des Lieferers gegen den Besteller ab, die durch die Verbindung der Kaufsache mit einem Grundstück gegen einen Dritten erwachsen.
- (10) Der Lieferer verpflichtet sich, die ihm zustehenden Sicherheiten auf Verlangen des Bestellers insoweit freizugeben, als der realisierbare Wert der Sicherheit des Lieferers die zu sichernde Forderung um mehr als 20 % übersteigt. Die Auswahl der freizugebenden Sicherheiten obliegt dem Lieferer.

§ 7 Gewährleistung / Haftung

- (1) Der Besteller ist verpflichtet, die gelieferte Ware auf offensichtliche Mängel, die ohne Weiteres auffallen, zu untersuchen. Zu den offensichtlichen Mängeln zählen beispielsweise erhebliche, leicht sichtbare Beschädigungen der Ware. Ferner sind Fälle hierunter zu fassen, in denen eine andere Sache oder eine zu geringe Menge geliefert werden. Solche offensichtlichen Mängel sind bei dem Lieferer innerhalb von zwei Wochen nach Lieferung schriftlich zu rügen. Bei Anlieferung erkennbarer Mängel, müssen zudem bei dem Transportunternehmen gerügt werden und die Aufnahme der Mängel von diesem veranlasst werden.
- (2) Mängel, die erst später offensichtlich werden, müssen beim Lieferer innerhalb von zwei Wochen nach dem Erkennen durch den Anwender gerügt werden. Bei Verletzung der Untersuchungs- und Rügepflicht durch den Besteller gilt die Ware in Ansehung des betreffenden Mangels als genehmigt.
- (3) Mängel der gelieferten Sache werden vom Lieferer innerhalb von einem Jahr ab Lieferung nach entsprechender Mitteilung durch den Besteller behoben. Dies geschieht nach Wahl des Bestellers durch kostenfreie Nachbesserung oder Ersatzlieferung. Im Falle der Ersatzlieferung ist der Besteller verpflichtet, die mangelhafte Sache zurückzugewähren.
- (4) Kann der Mangel nicht innerhalb angemessener Frist behoben werden oder ist die Nachbesserung oder Ersatzlieferung aus sonstigen Gründen als fehlgeschlagen anzusehen, kann der Besteller nach seiner Wahl Herabsetzung der Vergütung (Minderung) verlangen oder vom Vertrag zurücktreten. Von einem Fehlschlagen der Nachbesserung ist erst auszugehen, wenn dem Lieferer hinreichend die Gelegenheit zur Nachbesserung oder Ersatzlieferung eingeräumt wurde, ohne dass der gewünschte Erfolg erzielt wurde, wenn die Nachbesserung oder Ersatzlieferung vom Lieferer verweigert oder unzumutbar verzögert wird, wenn begründete Zweifel hinsichtlich der Erfolgsaussichten bestehen, oder wenn eine Unzumutbarkeit aus sonstigen Gründen vorliegt.
- (5) Die Haftung des Lieferers für leicht fahrlässige Pflichtverletzung wird ausdrücklich ausgeschlossen, sofern es sich nicht um vertragswesentliche Pflichten, Schäden aus der Verletzung des Lebens, des Körpers oder der Gesundheit oder Garantie handelt oder Ansprüche nach dem Produkthaftungsgesetz berührt sind. Gleiches gilt für Pflichtverletzungen der Erfüllungsgehilfen des Lieferers.
- (6) Schadensersatzansprüche, welche auf leicht fahrlässigen Pflichtverletzungen des Lieferers beruhen sowie sonstige vertragliche Ansprüche gegen den Lieferer verjähren ein Jahr nach Ablieferung der Sache. Sind vertragswesentliche Pflichten, Schäden aus der Verletzung des Lebens, des Körpers oder der Gesundheit, weitergehende Garantien oder Ansprüche nach dem Produkthaftungsgesetz betroffen, gelten die gesetzlichen Fristen.
- (7) Nicht vorhersehbare, vertragsuntypische Schäden sind, soweit nicht die Ausschlussstatbestände gemäß § 7 (5) gelten, von der Haftung ausgeschlossen.

§ 8 Anwendbares Recht, Erfüllungsort und Gerichtsstand

- (1) Für diese Verkaufs- und Lieferbedingungen und die gesamten Rechtsbeziehungen zwischen dem Besteller und dem Lieferer gilt das Recht der Bundesrepublik Deutschland unter Ausschluss von UN-Kaufrecht.
- (2) Erfüllungsort ist der Sitz des Lieferers (Reiskirchen).
- (3) Im Geschäftsverkehr mit Kaufleuten, juristischen Personen des öffentlichen Rechts oder bei öffentlich-rechtlichem Sondervermögen ist bei Klagen Gerichtsstand Gießen. Dies gilt auch für Klagen im Wechsel- und Scheckprozess. Gießen gilt auch dann zwischen dem Lieferer und Besteller als vereinbarter Gerichtsstand, falls der Besteller keinen allgemeinen Gerichtsstand in der Bundesrepublik Deutschland hat.

§ 9 Rücknahme

- (1) Stornierungen und Rücknahmen sind grundsätzlich ausgeschlossen, soweit dem Besteller nicht ein Recht zum Rücktritt zusteht. Einer Stornierung eines erteilten Auftrages oder einer Rücknahme stimmen wir nur in Ausnahmefällen und nur im Rahmen einer ausdrücklichen Vereinbarung zu. Im Falle einer ausnahmsweise vereinbarten Rücknahme erfolgt diese zudem nur nach Erteilung einer Rückwaren-Bearbeitungsnummer. Es werden mindestens 20 % Kostenanteil vom Warenwert, bzw. bei einem Warenwert unter € 50,- eine Pauschale von € 10,- an der Gutschrift abgesetzt. Die Ware muss in einem wiederverkaufsfähigen Zustand und originalverpackt (mindestens in Folie verpackt) sein.



Section 1 Scope of Application

(1) The services and offers of Bänninger Kunststoff-Produkte GmbH (hereinafter known as the Supplier) are performed exclusively on the basis of these terms and conditions of sale and delivery. These terms and conditions shall also apply to all future business transactions with the contract partner (hereinafter known as the Buyer), even if they have not been expressly agreed for each transaction. The Supplier does not recognize the application of the Supplier's General Terms and Conditions of Business deviating from these terms and conditions of sale and delivery, unless the Supplier has expressly agreed in writing to their application.

(2) Any and all agreements which have reached between the Supplier and the Buyer for the performance of this contract have been recorded in writing in this contract. Additional oral agreements have not been concluded between the Supplier and the Buyer.

(3) These terms and conditions of sale and delivery shall, at the latest, be deemed accepted upon acceptance of the goods or service by the Buyer.

(4) These terms and conditions of sale and delivery are applicable only with respect to companies in the sense of Section 310 BGB (Civil Code).

Section 2 Offer, Conclusion of Contract and Guarantee

(1) Any and all offers submitted by the Supplier are non-binding. Statements of acceptance and any and all orders shall not be legally effective unless confirmed in writing by the Supplier. If the Supplier does not send an order confirmation, the contract shall be deemed concluded if the Supplier delivers pursuant to the order and the Buyer accepts the goods.

(2) Drawings, pictures, dimensions, weights or other performance data contained in tables, advertising brochures, catalogues or similar documents from the Supplier are binding only if expressly agreed in writing.

(3) The Supplier shall be deemed to have given a guarantee only if and when the Supplier has designated in writing the relevant party as "guaranteed"

Section 3 Delivery Deadlines and Delivery Periods

(1) Delivery periods shall be binding only if expressly agreed in writing. Any and all other delivery deadlines are merely non-binding or approximate delivery dates or periods, which the Supplier will strive to observe.

(2) Delivery periods begin on the day of dispatch of the order confirmation by the Supplier, but not until all details of the performance of the delivery have been clarified and any and all conditions to be met by the Buyer have been fulfilled. If the Buyer requests changes after placing the order, a new delivery period shall commence upon confirmation of the change by the Supplier.

(3) Deliveries may be made before the lapse of the delivery period. The Supplier may forego sending an order confirmation if the goods are delivered immediately. In these cases, the confirmation may be replaced by a delivery note.

(4) The day of notification of readiness for dispatch, in other cases the day of dispatch of the goods, shall be deemed the delivery day. Deliveries ordered by call-up shall be accepted no later than six months after the order confirmation.

(5) The Supplier is entitled to make partial deliveries. Each and every partial delivery shall be deemed a separate and independent transaction.

(6) If the Supplier is in default of delivery, the Buyer must first grant to the Supplier a reasonable extension period. If this extension period lapses in vain, the Buyer may assert his rights according to, and subject to the conditions in, Sections 280, 281, 284, 286, 323 BGB.

(7) If, due to reasons for which the Supplier is not responsible, the Supplier's own suppliers do not perform deliveries or services, or do not perform them correctly, or do not perform them in due time, or in the event of incidents of force majeure, the Supplier shall notify the Buyer thereof in writing in due time. In these cases, the period shall be extended by the duration of the hindrance. The following circumstances are the equivalent of force majeure: industrial actions, intervention by government authorities, energy and raw material shortages, transport bottlenecks through no fault of the Supplier, operational disruptions through no fault of the Supplier such as fire, water damage and machine malfunctions, and any and all other hindrances which were, when viewed objectively, not culpably caused by the Supplier. If a delivery date or a delivery period has been agreed as binding, and if the agreed delivery date or the agreed delivery period is exceeded by more than two months as a consequence of various events, the Buyer is entitled to cancel the part of the contract which has not been fulfilled.

Section 4 Shipment and Transfer of Risk

(1) In the absence of written, deviating agreements, shipment shall be effected without insurance and at the risk and expense of the Buyer. Selection of the transport route and the means of transport shall be at the Supplier's discretion. The risk of accidental perishing or of accidental deterioration of the goods shall be transferred to the Buyer upon surrender of the goods of the delivery to the Buyer, the forwarding agent, the carrier or other company designated for performance of the shipment, at the latest upon the goods leaving the Supplier's plant/warehouse.

(2) To the extent that the shipment of the goods is delayed because the Supplier, as a consequence of whole or partial default of payment of the Buyer, exercises his right of retention, or due to other reasons for which the Buyer is responsible, the risk shall be transferred to the Buyer no later than on the date of notification of readiness for shipment.

(3) Goods which have been reported as ready for shipment must be called up without delay. Otherwise, the Supplier is entitled at his discretion to ship the goods or to store them at the Buyer's expense and risk.

(4) Installation instructions for the delivered goods can be obtained on the Supplier's home page (www.baenninger.de). The Buyer must notify the Supplier if he wishes to have the installation instructions in print form. In this case, the Supplier will provide the installation instructions to the Buyer.

Section 5 Prices and Terms and Conditions of Payment

(1) The Supplier's invoices are due and payable net within 30 days of the invoice date. A cash discount of 3% is granted for payments made within 10 days, to the extent that the Buyer is not in default of payment of receivables. The day the payment is credited to the Supplier's account is definitive. Interest for overdue payment at a rate of 8% above the current base rate will be charged on payments for which the Buyer is in default.

(2) Bills of exchange offered by the Buyer will be accepted by the Supplier only on account of performance and after express agreement and on the condition that said bills can be discounted. Discount fees will be charged as of the due date of the amount of the invoice by the Supplier. For bills of exchange and cheques, the day of their redemption shall be deemed the day of payment.

(3) If the Buyer does not observe the terms and conditions of payment, or if circumstances become known which in the reasonable commercial judgment of the Supplier give rise to justified doubts in the creditworthiness of the Buyer, including any such circumstances already existing at the time of the conclusion of the contract which, however, the Supplier was not aware of or had no cause to be aware of, the Supplier is entitled, without prejudice for further statutory rights, to discontinue further work on pending contracts or to suspend delivery, and to request advance payment or submission of appropriate collateral for outstanding deliveries, and, after the fruitless lapse of a reasonable period for the submission of said collateral – without prejudice for further statutory rights – to cancel the contract. The Buyer is obligated to compensate the Supplier for any and all damage resulting from the non-performance of the contract.

(4) The Buyer may set off any counterclaims against the Supplier only if said counterclaims have been legally and finally determined, are undisputed or have been acknowledged by the Supplier. In addition, the Buyer is entitled to exercise a right of retention only to the extent that his counterclaim results from the same contractual relationship.

(5) If not otherwise indicated in the order confirmation, the Supplier's prices, which are always given in euros, are EXW (ex works/warehouse) plus the currently applicable value-added tax. Prices do not include packaging, freight, postage and insurance. Said expenses shall be billed separately.

(6) In the event of a significant change in cost factors, such as an increase in material procurement costs, wage and ancillary wage costs and energy costs, the Supplier is entitled unilaterally to raise the price if there is a period of four months between the conclusion of the contract with the Buyer and the delivery of the goods.

Section 6 Retention of Title

(1) The Supplier retains title of ownership to the delivered goods (hereinafter known as the "purchase item") until any and all of the Supplier's receivables from the business relationship with the Buyer have been settled.

(2) The Buyer shall at his own expense provide insurance cover for the purchase item, in particular for fire and theft.

(3) The Buyer is entitled to sell further the purchase item in the course of ordinary business. Other disposals, in particular assignments or granting of equitable liens, are not permitted.

(4) If, upon further sale, the purchase item is not paid immediately in full by the third-party purchaser, the Buyer is obligated to sell further to the third-party purchaser only subject to retention of title.

(5) The right to further sale of the purchase item expires if the Buyer suspends payment or is in default of payment to the Supplier.

(6) The Buyer hereby assigns in advance to the Supplier any and all claims, including collateral and subsidiary rights, in the amount of the final invoice amount, including VAT, which arise for the Buyer against his customer or third parties from the further sale of the purchase item, independently of whether the purchase item is sold further with or without processing.

(7) In the event of attachments or other intervention by third parties, the Buyer shall notify the Supplier in writing immediately, providing any relevant documents, so that the Supplier can file protective action.

(8) Any processing or transformation of the purchase item shall at all times be performed on behalf of the Supplier. If the purchase item is processed together with other objects which do not belong to the Supplier, the Supplier shall acquire co-ownership in the new object in the ratio of the invoice value of the purchase item to the other processed objects at the time of the processing. Otherwise, the provisions applicable to the purchase item delivered subject to retention of title shall apply to the object resulting from the processing. If the purchase item is inseparably mixed with other objects which do not belong to the Supplier, the Supplier shall acquire co-ownership in the new object in the ratio of the invoice value of the purchase item to the other mixed objects at the time of the mixing. If the mixing occurs in such a manner that the Buyer's object shall be deemed the main object, it shall be deemed as agreed that the Buyer has assigned to the Supplier proportional co-ownership. The Buyer shall keep the resulting sole ownership or co-ownership in safe custody on the Supplier's behalf.

(9) To secure the Supplier's receivables due from the Buyer, the Buyer shall also assign to the Supplier the claims which arise for the former against third parties from the combining of the purchase item with land.

(10) The Supplier promises, at the request of the Buyer, to release collateral to which the former is entitled to the extent that the realizable value of the Supplier's collateral exceeds the amount of the receivables being secured by more than 20%. The selection of the collateral for release is at the discretion of the Supplier.

Section 7 Warranty / Liability

(1) The Buyer undertakes to examine the delivered goods for obvious defects which are detectable without special effort. Obvious defects include, for example, substantial, easily visible damage to the goods. This obligation also covers cases in which a different object or inadequate quantities are delivered. Complaint of such obvious defects shall be made to the Supplier no later than two weeks after delivery. Moreover, complaint of obvious defects must be made to the shipping company upon delivery; the Buyer shall request the shipping company to record the defects.

(2) Complaint of defects which do not become apparent until a later date must be submitted to the Supplier no later than two weeks following detection by the user. In the event of the Buyer's failure to fulfil his obligations to examine the goods and submit complaint, the goods shall be deemed as accepted with knowledge of the pertinent defects.

(3) Defects in the delivered object shall be eliminated by the Supplier no later than one year after delivery following appropriate notification by the Buyer. The defects may be eliminated, at the discretion of the Buyer, by subsequent remedy free of charge or by substitute delivery. If substitute delivery is performed, the Buyer is obligated to return the defective object.

(4) If the defect cannot be eliminated within a reasonable period, or if the subsequent remedy or substitute delivery is deemed to have failed for other reasons, the Buyer may, at his discretion, request reduction of the price or cancel the contract. Subsequent remedy shall not be deemed to have failed unless the Supplier has been given adequate opportunity to perform subsequent remedy or substitute delivery without achieving the desired result, or unless the subsequent remedy or substitute performance is refused or delayed unreasonably by the Supplier, unless justified doubt regarding the prospects for success exist, or unless there are other reasons for hardship.

(5) Liability of the Supplier for breach of obligation due to slight negligence is expressly excluded, to the extent that said breach is not related to essential obligations of the contract, to injuries to life, body or health or to guarantees, or affects claims arising from the Product Liability Act. The above provision also applies to breach of obligation by vicarious agents of the Supplier.

(6) Damage compensation claims arising from Supplier's breach of obligations due to slight negligence as well as other contractual claims on the Supplier shall become time-barred one year after delivery of the object. The statutory periods of limitation apply to breach of obligations essential to the contract, damage from injury to life, body or health, further guarantees or claims arising from the Product Liability Act.

(7) Unforeseeable damage which is not typical for the contract is excluded from the liability, to the extent that exclusion circumstances in accordance with Section 7 (5) do not apply.

Section 8 Proper Law, Place of Performance and Jurisdiction

(1) The law governing these terms and conditions of sales and all legal relationships between the Buyer and Supplier is the law of the Federal Republic of Germany, excluding the CISG.

(2) Place of performance is the Supplier's place of business (Reiskirchen).

(3) The courts of Giessen have jurisdiction for legal actions brought in relation to business with merchants, legal persons under public law or public law special funds. The above provision shall also apply with respect to legal actions regarding bills of exchange and cheques. The courts of Giessen shall also be agreed to have jurisdiction for Supplier and Buyer in the event that the Buyer is not subject to general jurisdiction in the Federal Republic of Germany.

Section 9 Return

(1) A return may be made only in exceptional cases and only after prior agreement and assignment of a returned goods processing number. A share of costs of no less than 20% of the value of the goods, or if the value of the goods is below €50.00, a lump-sum charge of €10.00 will be deducted from the amount of the credit note. The goods must be in a resalable condition and in the original packaging (at least packaged in foil). Specially moulded parts and pressed pipe elbows are generally excluded from return.





■ RELIABLE PARTNER WORLDWIDE ...



BÄNNINGER GROUP OF COMPANIES

Bänninger Kunststoff-Produkte GmbH

Bänningerstraße 1
35447 Reiskirchen
Germany

☎ +49 6408 89-0
☎ +49 6408 6756
info@baenninger.de
www.baenninger.de

Bänninger Rohrleitungssysteme GmbH

Athenslebener Weg 21
39418 Staßfurt
Germany

☎ +49 3925 96236-60
☎ +49 3925 96236-89
info.stassfurt@baenninger.de
www.baenninger.de

Baenninger Formtechnik Sp.z o.o

ul. Wojciecha Korfantego 11
42-202 Czestochowa
Poland

☎ +48 3432 31218

Baenninger Trading LLC

P.O. Box 474150
Dubai Investment Park 2
Dubai – United Arab Emirates

☎ +971 48857 955
☎ +971 48857 765
info@baenninger.ae
www.baenninger.ae

Baenninger, Inc.

1500 Broadway, Suite 1902
New York, NY 10036
United States of America
sales@baenninger-inc.com



ClimatePartner.com/10347-1812-1001



DPU1 0001 DE - 2010

